



rosehantrade.com

RoseBuild



**PRODUCT
CATALOG**



Paint Application

Easy to use efficient tools for Interior and Exterior wall paint applications.

Page 4-31



Cleaning Products

Cleaning products meet all industrial, wholesale and retail needs of institutions and organizations as the manufacturer with the latest technology.

Page 32-38

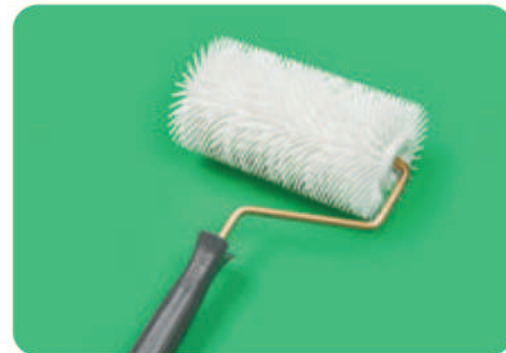

Construction Products

Building products are one of the first names that come to mind as manufacturers of solid and quality materials that are compatible with today's technology.

Page 39-49



Decoration Products

Decorative building products continue to be a part of your housework with their trend designs having high level of visual richness.

Page 50-53



Machines

Our machines successfully provide decorative painting and coating of large areas with a high amount of material on interior and Exterior facades.

Page 54



Stands

Our stands, which are specially designed for you, continue to be irreplaceable furniture of your work place.

*The products on the stand are sold on normal conditions.

Page 55-66

ROBOT

BRUSHES

Swivel head helps
you adjust desired
angle.

ROBOT BRUSHES



Oil Paint Robot Brushes



6467

3" / 76 mm
12 in a box



6468

4" / 100 mm
12 in a box

Chip Robot Brushes



6477

3" / 76 mm
12 in a box



6478

4" / 100 mm
12 in a box

- Swivel head helps you adjust desired angle.
- With the use of Extension Poles any edge points can be easily reached.
- A comfortable handle with an ergonomic hold for a smooth application use with no trace.
- Resistant to Solvent. No Bristles Loss.

Code	Width	Box
6467	3" / 76 mm	12
6468	4" / 100 mm	12
6477	3" / 76 mm	12
6478	4" / 100 mm	12



OIL PAINT

BRUSHES

Specially designed
for all types of paint
applications.



RoseBuild

OIL PAINT BRUSHES

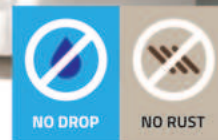

It is manufactured without the use of metal.

Plastic and wood mixed comfortable handle provides a smooth application and ergonomic hold.

Special formula helps holds more paint.

Long bristle length provides a comfortable soft paint application without trace.

For the back parts of radiators and all points where you cannot reach.

6061

Type: 2
1,6" / 40 mm
12 in a box

6062

Type: 3
2,3" / 60 mm
12 in a box

6063

Type: 4
3,1" / 80 mm
12 in a box

6060

Type: 1
0,8" / 20 mm
12 in a box

6064

Type: 5
4" / 100 mm
12 in a box

6081

Type: 2
1,6" / 40 mm
12 in a box

6082

Type: 3
2,3" / 60 mm
12 in a box

- Specially designed for all types of paint applications.
- Manufactured with no use of metal, no risk of corrosion.
- A comfortable handle with an ergonomic hold for a smooth application use with no trace. Resistant to Solvent. No Bristles Loss.
- Long lasting when cleaned and stored properly.

Code	Type	Width	Box
6060	1	0,8" / 20 mm	12
6061	2	1,6" / 40 mm	12
6062	3	2,3" / 60 mm	12
6063	4	3,1" / 80 mm	12
6064	5	4" / 100 mm	12
6081	2	1,6" / 40 mm	12
6082	3	2,3" / 60 mm	12

CHIP

PAINT BRUSHES



CHIP

PAINT BRUSHES



It is manufactured without the use of metal.

Plastic and wood mixed comfortable handle provides a smooth application and ergonomic hold.

Special formula helps holds more paint.

Long bristle length provides a comfortable soft paint application without trace.

6001

Type: 2
1,6" / 40 mm
12 in a box

6002

Type: 3
2,3" / 60 mm
12 in a box

6000

Type: 1
0,8" / 20 mm
12 in a box

6003

Type: 4
3,1" / 80 mm
12 in a box

For the back parts of radiators and all points where you cannot reach.

6021

Type: 2
1,6" / 40 mm
12 in a box

6022

Type: 3
2,3" / 60 mm
12 in a box

6004

Type: 5
4" / 100 mm
12 in a box

- Specially designed for all types of paint applications.
- Manufactured with no use of metal, no risk of corrosion.
- A comfortable handle with an ergonomic hold for a smooth application use with no trace. Resistant to Solvent. No Bristles Loss.
- Long lasting when cleaned and stored properly.

Code	Type	Width	Box
6000	1	0,8" / 20 mm	12
6001	2	1,6" / 40 mm	12
6002	3	2,3" / 60 mm	12
6003	4	3,1" / 80 mm	12
6004	5	4" / 100 mm	12
6021	2	1,6" / 40 mm	12
6022	3	2,3" / 60 mm	12



SYNTHETIC VARNISH

BRUSHES

SYNTHETIC VARNISH BRUSHES



It is manufactured without the use of metal.

Plastic and wood mixed comfortable handle provides a smooth application and ergonomic hold.

Special formula helps holds more paint.

6131

Type: 2
1,6" / 40 mm
12 in a box

Long bristle length provides a comfortable soft paint application without trace.

6132

Type: 3
2,3" / 60 mm
12 in a box

6130

Type: 1
0,8" / 20 mm
12 in a box

6133

Type: 4
3,1" / 80 mm
12 in a box

For the back parts of radiators and all points where you cannot reach.

6151

Type: 2
1,6" / 40 mm
12 in a box

6152

Type: 3
2,3" / 60 mm
12 in a box

6134

Type: 5
4" / 100 mm
12 in a box

- Specially designed for synthetic varnish applications.
- Manufactured with no use of metal, no risk of corrosion.
- A comfortable handle with an ergonomic hold for a smooth application use with no trace. Resistant to Solvent. No Bristles Loss.
- Long lasting when cleaned and stored properly.

Code	Type	Width	Box
6130	1	0,8" / 20 mm	12
6131	2	1,6" / 40 mm	12
6132	3	2,3" / 60 mm	12
6133	4	3,1" / 80 mm	12
6134	5	4" / 100 mm	12
6151	2	1,6" / 40 mm	12
6152	3	2,3" / 60 mm	12

EKSPORT

EMULSION PAINT ROLLER

Used on plane faces with satin and water-based paints. Efficiency of the roll, which is not affected by solvents, increases as used. Washing the roll with any solvent after using and rinsing with water prolongs the service life.



Eksport
Radiator Roller

1084	4" / 10 cm
	50 in a box



Eksport
Robot Roller

2084	4" / 10 cm
	12 in a box



Eksport Mid-size
Roller

3113	6" / 15 cm
	25 in a box



Eksport Roller

1080	8" / 20 cm
	25 in a box

Code	Length	Box
Radiator Roller		
2086	10" / 25 cm	50
2083	8" / 20 cm	50
2082	7" / 17,5 cm	50
1085	6" / 15 cm	50
2081	5" / 12,5 cm	50
1084	4" / 10 cm	50
1087	3" / 7,5 cm	50
1094	2" / 5 cm	50

Code	Length	Box
Radiator Roller Sleeves		
2186	10" / 25 cm	50
2183	8" / 20 cm	50
2182	7" / 17,5 cm	50
1101	6" / 15 cm	50
2181	5" / 12,5 cm	50
1100	4" / 10 cm	50
1104	3" / 7,5 cm	50
1103	2" / 5 cm	50

Code	Length	Box
Eksport Robot Roller		
2084	4" / 10 cm	12

Code	Length	Box
Mid-size Roller		
3116	10" / 25 cm	25
3115	8" / 20 cm	25
3114	7" / 17,5 cm	25
3113	6" / 15 cm	25
3112	5" / 12,5 cm	25
3111	4" / 10 cm	25

Code	Length	Box
Mid-size Roller Sleeves		
3016	10" / 25 cm	25
3015	8" / 20 cm	25
3014	7" / 17,5 cm	25
3013	6" / 15 cm	25
3012	5" / 12,5 cm	25
3011	4" / 10 cm	25

Code	Length	Box
Roller		
1081	10" / 25 cm	25
1093	9" / 23 cm	25
1080	8" / 20 cm	25
1082	6" / 15 cm	25
1083	4" / 10 cm	25

Code	Length	Box
Roller Sleeves		
1097	10" / 25 cm	25
1110	9" / 23 cm	25
1096	8" / 20 cm	25
1099	6" / 15 cm	25
1098	4" / 10 cm	25

PLASDEK

ROLLER



PLASDEK ROLLER

Used in plastic interior painting applications. Efficiency of the roll, which is not affected by solvents, increases as used. Washing the roll with any solvent after each use and rinsing with water prolongs the service life. Special types are also produced to be used in polyester application works.



Plasdek Roller

1015	8" / 20 cm
	25 in a box



Plasdek
Roller

1019	4" / 10 cm
	25 in a box

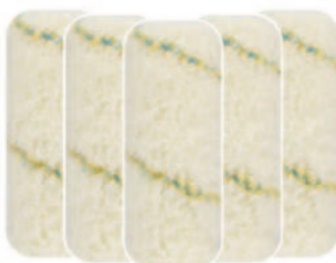

Plasdek
Roller Sleeve

1026	8" / 20 cm
	25 in a box



Plasdek
Roller

1420	11,8" / 30 cm
	6 in a box

Code	Length	Box
1017	10" / 25 cm	25
1015	8" / 20 cm	25
1018	6" / 15 cm	25
1019	4" / 10 cm	25

Sleeves

1027	10" / 25 cm	25
1026	8" / 20 cm	25
1028	6" / 15 cm	25
1029	4" / 10 cm	25

Large Roller

1423	23,6" / 60 cm	6
1422	19,7" / 50 cm	6
1421	15,7" / 40 cm	6
1420	11,8" / 30 cm	6

Large Roller Sleeves

1033	23,6" / 60 cm	20
1032	19,7" / 50 cm	20
1031	15,7" / 40 cm	20
1030	11,8" / 30 cm	20



SUPERLUKS

MASONRY PAINT

ROLLER

SUPERLUKS

MASONRY PAINT ROLLER

Superluks Roller

1001	8" / 20 cm
	25 in a box

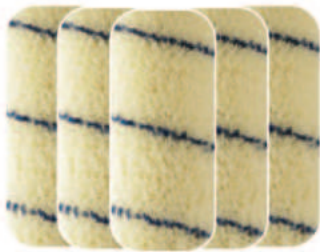

Superluks Sleeve

1020	8" / 20 cm
	25 in a box

Code	Length	Box
1003	10" / 25 cm	25
1002	9" / 23 cm	25
1001	8" / 20 cm	25
1004	6" / 15 cm	25
1005	4" / 10 cm	25

Sleeves

1022	10" / 25 cm	25
1021	9" / 23 cm	25
1020	8" / 20 cm	25
1023	6" / 15 cm	25
1024	4" / 10 cm	25



Superluks Roller

1005	4" / 10 cm
	25 in a box

Superluks Roller is used for External house-paints. Efficiency of the roll, which is not affected by solvents, increases as used. Washing the roll with any solvent after using and rinsing with water prolongs the service life.



SILTEKS

SILICON MASONRY
PAINT ROLLER



SILTEKS

SILICON MASONRY PAINT ROLLER



Silteks Roller

1010	8" / 20 cm
	25 in a box



Silteks Roller

1011	9" / 23 cm
	25 in a box

Used with External Silicon paints. Efficiency of the roll, which is not affected by solvents, increases as used. Washing the roll with any solvent after each use and rinsing with water prolongs the service life.



Silteks Roller

1012	10" / 25 cm
	25 in a box



Silteks Sleeve

1013	8" / 20 cm
	25 in a box

Code	Length	Box
1012	10" / 25 cm	25
1011	9" / 23 cm	25
1010	8" / 20 cm	25

Sleeves

1014	10" / 25 cm	25
1009	9" / 23 cm	25
1013	8" / 20 cm	25

SHEEPSKIN ROLLER



SHEEPSKIN ROLLER

Sheepskin Roller

1037	6" / 15 cm
	12 in a box



Used in plastic paint and External house-painting applications. Made of natural lamb and sheep fleece.



Code	Length	Box
1036	10" / 25 cm	12
1035	8" / 20 cm	12
1037	6" / 15 cm	12
1038	4" / 10 cm	12

Sleeves

1051	10" / 25 cm	25
1050	8" / 20 cm	25
1045	6" / 15 cm	25
1052	4" / 10 cm	25

Extra Sheepskin Roller

1040	8" / 20 cm	12
------	------------	----

Radiator Roller

1039	4" / 10 cm	50
------	------------	----

Radiator Roller Sleeve

1053	4" / 10 cm	50
------	------------	----



Sheepskin Sleeve

1050	8" / 20 cm
	25 in a box



Sheepskin Roller

1038	4" / 10 cm
	12 in a box



VARNISH

& OIL PAINT
ROLLER

VARNISH & OIL PAINT ROLLER

Used with varnish and oil paints. Efficiency of the roll, which is not affected by solvents, increases as used. Washing the roll with any solvent after using and rinsing with water prolongs the service life.



Varnish
& Oil Paints
Radiator Roller

2090	2" / 5 cm
	25 in a box



Varnish
& Oil Paints
Radiator Roller
(Short handle)

2068	4" / 10 cm
	50 in a box



Varnish
& Oil Paints
Radiator Roller

1068	4" / 10 cm
	50 in a box

Varnish & Oil
Paints Roller

1065	8" / 20 cm
	25 in a box



Code	Length	Box
1064	10" / 25 cm	25
1065	8" / 20 cm	25
1067	6" / 15 cm	25
1066	4" / 10 cm	25

Sleeves

1075	10" / 25 cm	25
1076	8" / 20 cm	25
1077	6" / 15 cm	25
1078	4" / 10 cm	25

Radiator Roller

2085	10" / 25 cm	50
2093	8" / 20 cm	50
2092	7" / 17,5 cm	50
1069	6" / 15 cm	50
2091	5" / 12,5 cm	50
1068	4" / 10 cm	50
2068	4" / 10 cm	50
2090	2" / 5 cm	25

Radiator Roller Sleeves

2185	10" / 25 cm	50
2193	8" / 20 cm	50
2192	7" / 17,5 cm	50
1072	6" / 15 cm	50
2191	5" / 12,5 cm	50
1079	4" / 10 cm	50
2089	2" / 5 cm	50

Radiator
Roller
Ø 1"
2,5 cm

Mid-size
Roller
Ø 1,4"
3,5 cm

Normal
Roller
Ø 2,2"
5,5 cm



Varnish & Oil
Paints Mid-size
Roller

3103	6" / 15 cm
	25 in a box

Code	Length	Box
Mid-size Roller		
3106	10" / 25 cm	25
3105	8" / 20 cm	25
3104	7" / 17,5 cm	25
3103	6" / 15 cm	25
3102	5" / 12,5 cm	25
3101	4" / 10 cm	25

Mid-size Roller Sleeve

3006	10" / 25 cm	25
3005	8" / 20 cm	25
3004	7" / 17,5 cm	25
3003	6" / 15 cm	25
3002	5" / 12,5 cm	25
3001	4" / 10 cm	25

FOAM

PAINT ROLLER



FOAM PAINT ROLLER



Foam Paint Roller

1112	8" / 20 cm
	12 in a box



Ideal for use with gloss paints for a smooth finish.

Foam Radiator Roller

1115	4" / 10 cm
	25 in a box



Foam Radiator Roller

1111	2" / 5 cm
	50 in a box



Foam Paint Roller

1114	4" / 10 cm
	25 in a box



Mini Paint Tray

1184	5,7" x 9,2" x 1,8"
	14,5 x 23,5 x 4,5 cm
	12 in a box

Code	Length	Box
1113	9" / 23 cm	12
1112	8" / 20 cm	12
1114	4" / 10 cm	25

Sleeves

1131	9" / 23 cm	25
1130	8" / 20 cm	25
1133	4" / 10 cm	25

Radiator Roller

1115	4" / 10 cm	25
1111	2" / 5 cm	50

Radiator Roller Sleeves

1132	4" / 10 cm	50
1134	2" / 5 cm	50

PAINT ACCESSORIES



19 LITER PAINT



Jumbo Paint Bucket

1141	16,1" x 21,3" x 8,3"
	41 x 54 x 21 cm
	5 gallon / 19 lt paint
	6 in a box

11 LITER PAINT

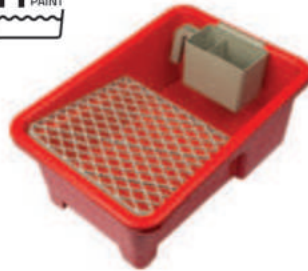

Large Painter Set

1180	13,8" x 19,7" x 8,3"
	35 x 50 x 21 cm
	3 gallon / 11 lt paint
	4 in a box



It's a functional painter's container with a volume of 3 gal. / 11 liters consisting of 3 pieces. Includes 2-cell tankard and paint roller grid attachable on large painter's container. Tankard consists of brush keeping cell and paint cell.

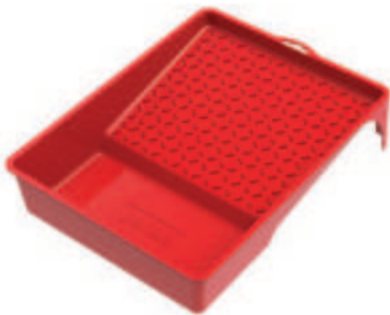

Paint Tray
(for 8" / 20 cm paint roller)

1219	10" x 13,8" x 2,8"
	25,5 x 35 x 7,2 cm
	12 in a box

Small Paint Tray

1179	6" x 13,6" x 1,8"
	15 x 34,5 x 4,5 cm
	12 in a box



Paint tray with grid surface is one of the assistance of painters.

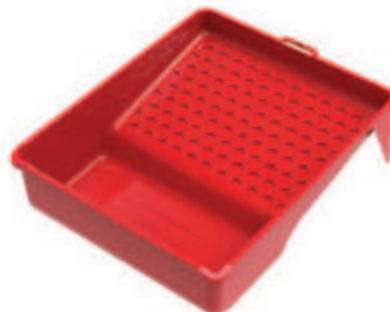

Paint Tray

1181	12,6" x 15,7" x 4,1"
	32 x 40 x 15 cm
	10 in a box



Paint Tray Liner

1183	12,6" x 15,7" x 4,1"
	32 x 40 x 15 cm
	50 in a box

Code	Dimensions	Box
1141	41 x 54 x 21 cm	6
1179	5 x 34,5 x 4,5 cm	12
1180	35 x 50 x 21 cm	4
1181	32 x 40 x 10,5 cm	10
1183	32 x 40 x 10,5 cm	50
1219	25,5 x 35 x 7,2 cm	12



Radiator Paint Roller Grid

1197	6" × 13,6" × 1,3"
	15 × 34,5 × 3,3 cm
	40 in a box



Paint Roller Grid

1185	10,2" × 13,4" × 1,6"
	26 × 34 × 4 cm
	24 in a box



Paint Roller Grid can be used comfortably with 10" / 25 cm wide paint rollers. Flexible side straps allows the possibility of adaptable different to the bucket.



Amateur Paint Set

1190	12,6" × 15,7" × 4,1"
	32 × 40 × 15 cm
	2 in a box

- Paint Tray
- 8" / 20 cm Eksport Paint Roller
- 4" / 10 cm Eksport Radiator Roller
- 2,4" / 60 mm Paint Brush
- 32,80 ft / 10 meter Plastic Sheet



Hobby Paint Set

1182	5,7" × 9,2" × 1,8"
	14,5 × 23,5 × 4,5 cm
	12 in a box

- Paint Tray
- 2" / 5 cm Varnish & Oil Paints Radiator Roller
- 2" / 5 cm Varnish & Oil Paints Radiator Roller Sleeve
- Number 10 Pencil Brush
- 0,8" / 20 mm Paint Brush



Paint Cup

1392	4" × 8,3" × 4,6"
	10,2 × 21 × 11,8 cm
	6 in a box

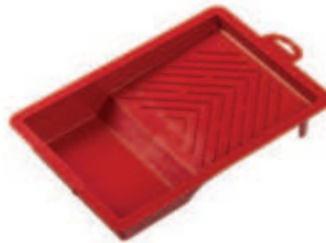

Paint Paddle Sticks

1390	13"
	33 cm
	40 in a box

Mini Paint Tray

1184	5,7" × 9,2" × 1,8"
	14,5 × 23,5 × 4,5 cm
	12 in a box



Paint Paddle Sticks (Perforated)

1391	13"
	33 cm
	40 in a box

Code	Dimensions	Box
1182	14,5 × 23,5 × 4,5 cm	12
1184	14,5 × 23,5 × 4,5 cm	12
1185	26 × 34 × 4 cm	24
1188	18 cm	12
1190	32 × 40 × 10,5 cm	2
1197	15 × 34,5 × 3,3 cm	40
1390	33 cm	40
1391	33 cm	40
1392	10,2 × 21 × 11,8 cm	6



Robot Brush

1188	7"
	18 cm
	12 in a box

Facilitates paint applications in narrow and difficult areas where shortcut is required with the adjustable movable head inserted on the rod end without a stair needed.

PREMIUM

SERIE

19 LITER PAINT



Premium Jumbo Paint Bucket

1487	16,1" x 21,3" x 8,3"
	41 x 54 x 21 cm
	5 gallon / 19 lt paint
	6 in a box

11 LITER PAINT



Premium Large Paint Bucket

1486	13,8" x 19,7" x 8,3"
	35 x 50 x 21 cm
	3 gallon / 11 lt paint
	4 in a box

Premium Paint Tray
(for 8" / 20 cm paint roller)

1484	10" x 13,8" x 2,8"
	25,5 x 35 x 7,2 cm
	12 in a box

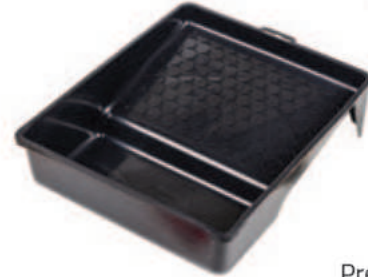

Premium Paint Tray
(for 10" / 25 cm paint roller)

1485	12,6" x 15,7" x 4,1"
	32 x 40 x 10,5 cm
	10 in a box



Premium Small Paint Tray

1483	6" x 13,6" x 1,8"
	15 x 34,5 x 4,5 cm
	12 in a box



Premium Hobby Paint Tray

1482	5,7" x 9,2" x 1,8"
	14,5 x 23,5 x 4,5 cm
	12 in a box

Premium Paint Roller Grid
(for 10" / 25 cm paint roller)

1481	10,2" x 13,4" x 1,6"
	25 x 34 x 4 cm
	24 in a box



Premium Paint Roller Grid
(for 4" / 10 cm paint roller)

1480	6" x 13,6" x 1,3"
	15 x 34,5 x 3,3 cm
	40 in a box

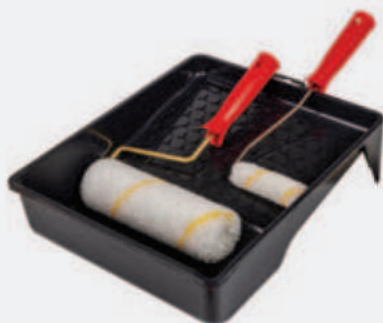

Premium Paint Set

1491	12,6" x 15,7" x 4,1"
	32 x 40 x 10,5 cm
	2 in a box

- Paint Tray
- 8" / 20 cm Eksport Paint Roller
- 4" / 10 cm Eksport Radiator Roller



Premium Hobby Paint Set

1490	5,7" x 9,2" x 1,8"
	14,5 x 23,5 x 4,5 cm
	12 in a box

- Paint Tray
- 2" / 5 cm Foam Radiator Roller
- 2" / 5 cm Foam Radiator Roller Sleeve

Code	Dimensions	Box
1480	15 x 34,5 x 3,3 cm	40
1481	26 x 34 x 4 cm	24
1482	14,5 x 23,5 x 4,5 cm	12
1483	15 x 34,5 x 4,5 cm	12
1484	25,5 x 35 x 7,2 cm	12
1485	32 x 40 x 10,5 cm	10
1486	35 x 50 x 21 cm	4
1487	35 x 50 x 21 cm	6
1490	14,5 x 23,5 x 4,5 cm	12
1491	32 x 40 x 10,5 cm	2

COMPOSITE POLES

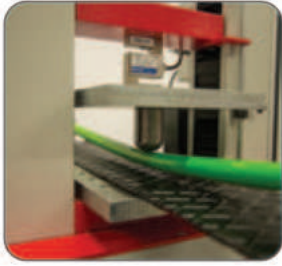

Due to the composite structure of plastic and sheet metal combined with a special technique, it is at least 30% more resistant to bending from similar size poles.



Because of its plastic coated surface, it is highly resistant to corrosion and it is long-lasting.



The universal end is compatible with many apparatuses.



It provides ease of purchase and sales with its economical price.

Adjustable Composite Pole

2 Stage Composite Extension Pole

Code	max (m)	min (cm)	Stage	Box
1360	1	63	2	12
1361	1,5	87	2	12
1362	2	112	2	12
1363	2,5	140	2	12
1364	3	164	2	12



Composite Fixed Poles



With its five different color options in its box, it provides choice according to the taste of the customer.

Code	Length (m)	Box
1365	1,2	25
1366	1,5	25
1367	1,8	25
1368	2	25



It can also be used as a display stand for its sale, with the apparatus which comes with its box and with its easy opening cap.

Premium Composite Pole



Code	Length (m)	Box
2365	1,2	36

EXTENSION POLES

It's length can be adjusted.
Wooden tip provides multi purpose usage.



Light Aluminium Pole
(Stable)

Code	Max (m)	Min (cm)	Stage	Box
1276	1,2	-	-	25
1277	1,5	-	-	25
1278	1,75	-	-	25
1279	2	-	-	25



2 Stage Light Aluminium
Extension Pole

Code	Max (m)	Min (cm)	Stage	Box
1291	1,5	88	2	12
1292	2	115	2	12
1293	2,5	132	2	12
1294	3	162	2	12



3 Stage Light Aluminium
Extension Pole

Code	Max (m)	Min (cm)	Stage	Box
1295	2	86	3	8
1296	4	151	3	8
1297	6	216	3	6
1299	8	410	3	4



2 Stage Light Aluminium
Slender Extension Pole

Code	Max (m)	Min (cm)	Stage	Box
1280	1,5	90	2	12
1281	2	115	2	12
1282	2,5	136	2	12
1283	3	163	2	12



2 Stage Aluminium
Thick Extension Pole

Code	Max (m)	Min (cm)	Stage	Box
1170	1,5	88	2	8
1171	2	114	2	8
1172	2,5	135	2	8
1173	3	165	2	8
1174	4	216	2	6
1176	5	265	2	6
1175	6	316	2	6



3 Stage Aluminium
Thick Extension Pole

Code	Max (m)	Min (cm)	Stage	Box
1270	2	89	3	8
1271	2,5	103	3	8
1272	3	120	3	8
1273	4	154	3	8
1274	5	186	3	6
1275	6	220	3	6



Thick Tipped
Aluminium Pole (Stable)

Code	Max (m)	Min (cm)	Stage	Box
1269	1,2	-	-	8
1290	1,5	-	-	8



Trawl Extension Pole

Code	Max (m)	Min (cm)	Stage	Box
1178	1,4	60	3	8



Extension Pole Adaptor

Code	Box
9954	25

* Can be used with Sweeping Brushes and 11,8" / 30 cm Scraper.

WOODEN SWEEPING YARD BRUSHES

Hard fiber bristles makes it easy to sweep hard debris and garbage in such as areas of constructions, factories, parks, municipalities, airports and similar areas.

- It has a hard fiber bristles.
- Used for sweeping hard objects.
- Long lasting wooden brush.
- Suitable for wet and dry surfaces.
- Use for household or industrial applications.



6266	47.2"
	120 cm
	2 in a box

Code	Width	Box
6260	11.8" / 30 cm	12
6261	15.7" / 40 cm	12
6262	19.7" / 50 cm	12
6263	23.6" / 60 cm	12
6264	31.5" / 80 cm	6
6265	39.4" / 100 cm	2
6266	47.2" / 120 cm	2

6265	39.4"
	100 cm
	2 in a box

6264	31.5"
	80 cm
	6 in a box



6263	23.6"
	60 cm
	12 in a box

6261	15.7"
	40 cm
	12 in a box

6260	11.8"
	30 cm
	12 in a box

6262	19.7"
	50 cm
	12 in a box



Use with
Thick Tipped
Aluminium Pole.
Page: 31



DUAL BROOMS

The black hard bristles on the edges sweep the hard objects.

The blue soft bristles in the middle sweep the dust.

It has a hard and soft fiber bristle.
Used for sweeping hard objects.
Long lasting wooden brush.
Suitable for wet and dry surfaces.
Use for household or industrial applications.

6308
23,6" / 60 cm
12 in a box

6307
19,7" / 50 cm
12 in a box

6303
23,6" / 60 cm
12 in a box

6305
11,8" / 30 cm
12 in a box

6306
15,7" / 40 cm
12 in a box

6300
11,8" / 30 cm
12 in a box

6302
19,7" / 50 cm
12 in a box

6301
15,7" / 40 cm
12 in a box

Use with Composite Fixed Pole (1365,1366) Page: 30

Use with Light Aluminium Pole (Stable). Page: 31

Use with Adjustable Composite Pole Page: 30

Code	Width	Box
Dual Brooms		
6300	11.8" / 30 cm	12
6301	15.7" / 40 cm	12
6302	19.7" / 50 cm	12
6303	23.6" / 60 cm	12
Premium Dual Brooms		
6305	11.8" / 30 cm	12
6306	15.7" / 40 cm	12
6307	19.7" / 50 cm	12
6308	23.6" / 60 cm	12

PLASTIC SWEEPING

YARD BRUSHES

It has a hard fiber bristle.
Used for sweeping hard objects.
Long lasting wooden brush.
Suitable for wet and dry surfaces.
Use for household or industrial applications.



6253
23,6" / 60 cm
12 in a box

6258
23,6" / 60 cm
12 in a box

6257
19,7" / 50 cm
12 in a box

6256
15,7" / 40 cm
12 in a box

6255
11,8" / 30 cm
12 in a box

6252
19,7" / 50 cm
12 in a box

6251
15,7" / 40 cm
12 in a box

6250
11,8" / 30 cm
12 in a box

Use with
Composite Fixed
Pole (1365,1366)
Page: 30

Use with Light
Aluminium Pole
(Stable).
Page: 31

Use with
Adjustable
Composite Pole
Page: 30

Code	Width	Box
------	-------	-----

Plastic Sweeping Yard Brushes

6250	11.8" / 30 cm	12
6251	15.7" / 40 cm	12
6252	19.7" / 50 cm	12
6253	23.6" / 60 cm	12

Premium Plastic Sweeping Yard Brushes

6255	11.8" / 30 cm	12
6256	15.7" / 40 cm	12
6257	19.7" / 50 cm	12
6258	23.6" / 60 cm	12



PLASTIC SWEEPING BRUSHES

It has a soft fiber bristle.
 Used for indoor and outdoor sweeping brush.
 Long lasting plastic brush.
 Suitable for wet and dry surfaces.
 Use for household or industrial applications.

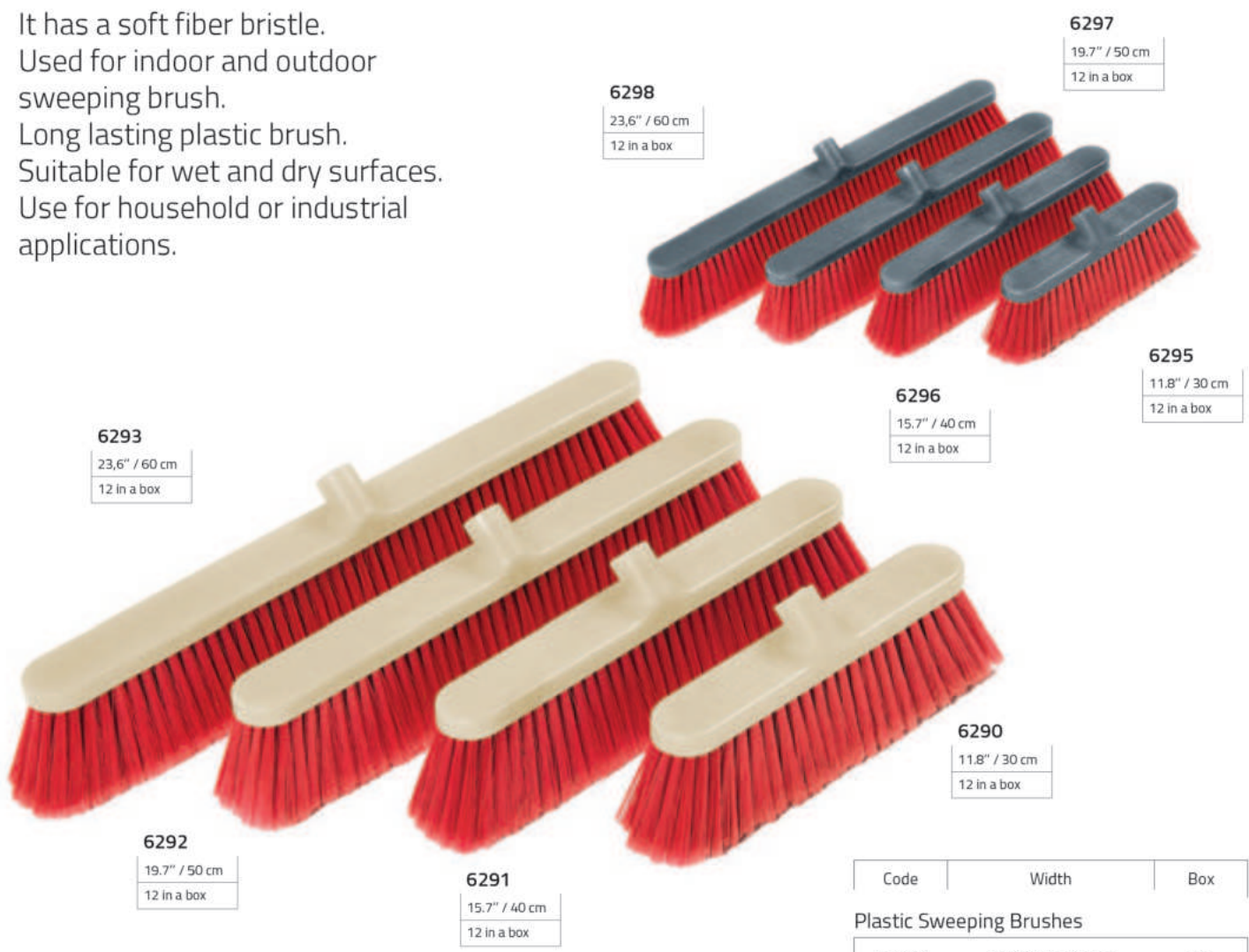

6293
 23.6" / 60 cm
 12 in a box

6298
 23.6" / 60 cm
 12 in a box

6297
 19.7" / 50 cm
 12 in a box

6296
 15.7" / 40 cm
 12 in a box

6295
 11.8" / 30 cm
 12 in a box

6290
 11.8" / 30 cm
 12 in a box

6292
 19.7" / 50 cm
 12 in a box

6291
 15.7" / 40 cm
 12 in a box

Use with
 Composite Fixed
 Pole (1365,1366)
 Page: 30

Use with Light
 Aluminium Pole
 (Stable).
 Page: 31

Use with
 Adjustable
 Composite Pole
 Page: 30



Code	Width	Box
------	-------	-----

Plastic Sweeping Brushes		
6290	11.8" / 30 cm	12
6291	15.7" / 40 cm	12
6292	19.7" / 50 cm	12
6293	23.6" / 60 cm	12

Premium Plastic Sweeping Brushes		
6295	11.8" / 30 cm	12
6296	15.7" / 40 cm	12
6297	19.7" / 50 cm	12
6298	23.6" / 60 cm	12

AUTO AND MARINE BRUSHES



Double Flow-Thru auto and marine wash brush. Long lasting plastic brush, not affected from hot water. Soft bristles make it safe for clear coat paint. Use for household or industrial applications with standard hose.

Double water flow-thru.



Auto Washing Brush

6220	10"
	25 cm
	12 in a box

Water flow-thru.



Marine Washing Brush

6231	13"
	33 cm
	4 in a box

Double water flow-thru.



Extra Auto Washing Brush

6221	10"
	25 cm
	12 in a box

Water flow-thru.



Extra Marine Washing Brush

6230	13"
	33 cm
	4 in a box



Premium Auto Washing Brush

6219	10"
	25 cm
	12 in a box



Easy on and off removable clamp. Special structure allows to water flow-thru.



Wash Brush with Pole

6223	3,9 ft
	1,2 m
	36 in a box

Sale with wash brush.

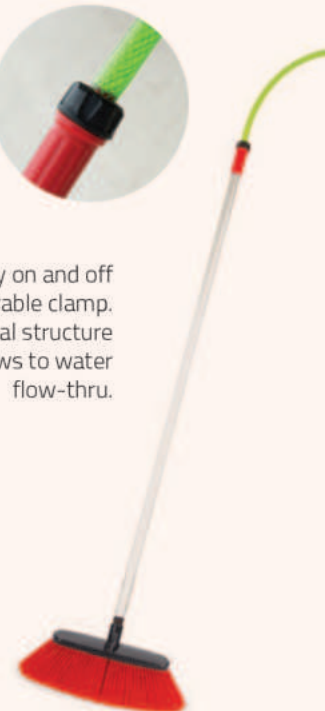

Flow-Thru Water Pole

1289	3,6 ft
	1,1 m
	12 in a box

Brush sold separately.



For removing stains on carpets.



Double water flow-thru.

Carpet Cleaning Brush

6240	9,4"
	24 cm
	12 in a box



For brushing the corners that are difficult to wipe.



Water flow-thru.

Corner Scrub Brush

6270	9,4"
	24 cm
	2 in a box



For brushing the grounds.



Scrub Brush

6271	11,4"
	29 cm
	6 in a box



For removing dirt from oily surfaces.



Soft Wire Brush

6200	5,1"
	13 cm
	12 in a box



For brushing the rusty and hard surfaces.



Hard Wire Brush

6201	5,1"
	13 cm
	12 in a box



For dust or for general cleaning.



Hand Brush

6280	5,1"
	13 cm
	12 in a box

MIXER HEADS



For use in application of materials like paints, plaster, mortar, filler, lacquers, etc. with drills or mixing machines.



Up to **30** kilos.

✓ Mortar ✓ Plaster

Mortar Mixer Head

1208

Height: 23,2" / 59 cm
6 in a box



It only fits to drills with M14 bits.

Up to **30** kilos.

✓ Mortar ✓ Plaster

Mortar Mixer Head - M14

1517

Height: 23,2" / 59 cm
6 in a box



It only fits to drills with SDS Plus bits.

Up to **30** kilos.

✓ Mortar ✓ Plaster

Mortar Mixer Head - SDS Plus

1518

Height: 23,2" / 59 cm
6 in a box



Up to 25 kilos.

✓ Mortar ✓ Paint ✓ Plaster

Mixer Head

1514	Height: 23,2" / 59 cm
	12 in a box



Up to 25 kilos.

✓ Mortar ✓ Paint ✓ Plaster

Mixer Head -SDS PLus

1714	Height: 23,2" / 59 cm
	12 in a box



Up to 10 kilos.

✓ Mortar ✓ Paint ✓ Plaster

Mixer Head -SDS PLus

1715	Height: 17,7" / 45 cm
	12 in a box



Up to 10 kilos.

✓ Mortar ✓ Paint ✓ Plaster

Mixer Head

1515	Height: 16,1" / 41 cm
	12 in a box



Up to 25 kilos.

✓ Mortar ✓ Paint ✓ Plaster

Mixer Head -SDS PLus

1519	Height: 17,7" / 45 cm
	12 in a box



Up to 25 kilos.

✓ Mortar ✓ Paint ✓ Plaster

Mixer Head

1209	Height: 17,7" / 45 cm
	12 in a box



Up to 25 kilos.

✓ Mortar ✓ Paint ✓ Plaster

Butterfly Mixer Head

1513	Height: 18,5" / 47 cm
	12 in a box



Up to 25 kilos.

✓ Mortar ✓ Paint ✓ Plaster

Butterfly Mixer Head-SDS PLus

1713	Height: 18,5" / 47 cm
	12 in a box





Up to **30** kilos.

✓ Mortar ✓ Plaster

Jumbo Nano Mixer Head

1521

Height: 23,6" / 60 cm
2 in a box



Up to **10** kilos.

✓ Paint ✓ Plaster

Mixer Head

1512

Height: 17,3" / 44 cm
12 in a box



Up to **15** kilos.

✓ Paint ✓ Plaster

Mixer Head

1510

Height: 17" / 43 cm
12 in a box



Up to **5** kilos.

✓ Mortar ✓ Paint ✓ Plaster

Mixer Head

1516

Height: 10" / 25 cm
12 in a box



Up to **15** kilos.

✓ Paint ✓ Plaster

Auger Mixer Head

1511

Height: 15" / 38 cm
12 in a box



Up to **25** kilos.

✓ Paint ✓ Plaster

Mixer Head

1520

Height: 10" / 25 cm
12 in a box

Code	Product	Head	Height	Diameter	Side	Mix (kg)	Power (w)	Box
1208	Mortar Mixer Head	Hexagon	23,2" / 59 cm	5,5" / 14 cm	0,5" / 12 mm	15 - 30	1000	6
1209	Mixer Head	Hexagon	17,7" / 45 cm	3,3" / 8,5 cm	0,4" / 10 mm	10 - 25	600	12
1510	Mixer Head	Hexagon	17" / 43 cm	2,6" / 6,5 cm	0,3" / 8 mm	5 - 15	500	12
1511	Auger Mixer Head	Hexagon	15" / 38 cm	1,6" / 4 cm	0,4" / 10 mm	0-15	1000	12
1512	Mixer Head	Hexagon	17,3" / 44 cm	3,1" / 8 cm	0,3" / 8 mm	10	500	12
1513	Butterfly Mixer Head	Hexagon	18,5" / 47 cm	3,5" / 9 cm	0,4" / 10 mm	25	600	12
1514	Mixer Head	Hexagon	23,2" / 59 cm	3,5" / 9 cm	0,4" / 10 mm	10 - 25	700	12
1515	Mixer Head	Hexagon	16,1" / 41 cm	2,4" / 6 cm	0,3" / 8 mm	5 - 10	500	12
1516	Mixer Head	Circle	10" / 25 cm	1,6" / 4 cm	0,2" / 6 mm	0 - 5	500	12
1517	Mortar Mixer Head	M14	23,2" / 59 cm	5,5" / 14 cm	0,6" / 14 mm	15 - 30	1000	6
1518	Mortar Mixer Head	SDS Plus	23,2" / 59 cm	5,5" / 14 cm	0,6" / 14 mm	15 - 30	1000	6
1519	Mixer Head	SDS Plus	17,7" / 45 cm	3,3" / 8,5 cm	0,4" / 10 mm	10 - 25	600	12
1520	Mixer Head	Circle	10" / 25 cm	2,4" / 6 cm	0,2" / 6 mm	25	600	12
1521	Jumbo Nano Mixer Head	SDS Plus	23,6" / 60 cm	8,7" / 22 cm	0,5" / 12 mm	15 - 30	1000	2
1713	Butterfly Mixer Head	SDS Plus	18,5" / 47 cm	3,5" / 9 cm	0,4" / 10 mm	25	600	12
1714	Mixer Head	SDS Plus	23,2" / 59 cm	3,5" / 9 cm	0,5" / 12 mm	10 - 25	700	12
1715	Mixer Head	SDS Plus	17,7" / 45 cm	2,4" / 6 cm	0,4" / 10 mm	5 - 10	500	12

EPOXY PRODUCTS

It is used for Extracting air bubbles in epoxy chemicals.



Epoxy Spiked Roller (Large)

1223	8" / 20 cm
	2 in a box



1226

Epoxy Spiked Roller (Large)

1224	10" / 25 cm
	2 in a box



Epoxy Spiked Roller (Small)

1222	11,8" / 30 cm
	2 in a box

1225



1220



Epoxy Spiked Roller (Small)

1221	10" / 25 cm
	2 in a box

Code	Length	Diameter	Box
1226	4" / 10 cm	2,8" / 7cm	2
1220	8" / 20 cm	2,8" / 7cm	2
1221	10" / 25 cm	2,8" / 7cm	2
1222	11,8" / 30cm	2,8" / 7cm	2
1223	8" / 20 cm	4,3" / 11 cm	2
1224	10" / 25 cm	4,3" / 11 cm	2
1225	11,8" / 30cm	4,3" / 11 cm	2

Used for facilitating walking by wearing under the shoes on grounds where epoxy mortars and chemical resins are applied.



Epoxy Nailed Shoes

1126	12,2" / 31 cm
	1 pair

Adjustable Epoxy Stage Trowel

1140	27,6" / 70 cm
	6 in a box



Epoxy Stage Trowel
1127

1 in a box
19,7" / 50 cm

Used in spreading epoxy and checimal resins. Level height can be adjusted by means of screws on the top.



Hot Isolation Roller



1034	8" / 20 cm
	12 in a box

Wallpaper Seam Roller



1169	7" x 1,8"
	18 x 4,5 cm
	6 in a box



1168	3,5" x 1,8"
	9 x 4,5 cm
	6 in a box



1167	1,8" x 1,8"
	4,5 x 4,5 cm
	6 in a box

Aluminium Crushing Roller

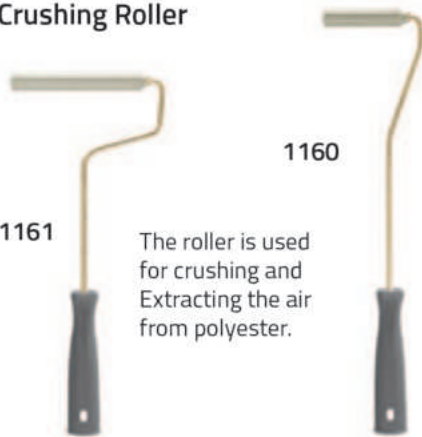

1160

1161

The roller is used for crushing and extracting the air from polyester.

Code	Length	Ø	Box
1160	3,1" / 8 cm	0,8" / 2 cm	25
1161	5,1" / 13 cm	0,8" / 2 cm	25

Sleeves

1162	3,1" / 8 cm	0,8" / 2 cm	25
1163	5,1" / 13 cm	0,8" / 2 cm	25

Rubber Squeegee with Plastic Frame

1210



1249



Heavy Duty Floor Wiper with Metal Frame

Code	Length	Box
Rubber Squeegee with Plastic Frame		
1210	16,7" / 42,5 cm	12
1410	20,7" / 52,5 cm	12
Heavy Duty Floor Wiper with Metal Frame		
1249	15,7" / 40 cm	12
1250	23,6" / 60 cm	12

BOAT HOOK

It is used for helping boats and rowboats to come abroad and it is also used for them to pull rope.

1284

Code	Max (ft / m)	Min (inch / cm)	Box
Boat Hook (Stabile)			
1284	4,92 / 1,5	-	6
Adjustable Boat Hook			
1285	4,92 / 1,5	37,4 / 95	6
1286	6,56 / 2	47,2 / 120	6
1287	8,20 / 2,5	57,7 / 144	6
1288	9,84 / 3	67,3 / 171	6

1285



1286



1287



1288



SCRAPERS



Aluminium Grip Scraper

1532	2,8" × 11,4"
	7 × 29 cm
	12 in a box



Aluminium Scraper

1529	1,77" × 10,6"
	4,5 × 27 cm
	12 in a box



Aluminium Scraper

1531	1,8" × 43,3"
	4,5 × 110 cm
	6 in a box



Aluminium Scraper Spare

5102	0,9" × 2,8"
	2,2 × 7 cm
	25 in a box

With Tungsten Carbide blade which is ideal for removing paint, varnish & Coating from wood.



Aluminium Scraper Spare (for 1529 and 1531)

5103	0,9" × 1,8"
	2,2 × 4,5 cm
	25 in a box

For use in various scraping works. Adjustable handle eases usage in wide area applications.

Used in various scraping works. Tip can be changed or reversed.



Wood Handle Scraper

1204	2,4" × 10,6"
	6 × 27 cm
	12 in a box

Used for scraping boats, yachts parquets.

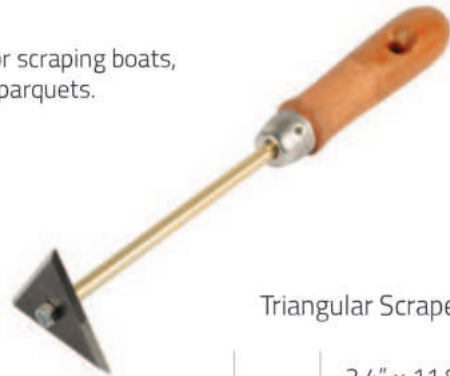

Triangular Scraper

1211	2,4" × 11,8"
	6 × 30 cm
	12 in a box



Spare Knife for Wood Handle Scraper

5100	2" × 2,4"
	5 × 6 cm
	25 in a box



Spare Knife for Triangular Scraper

5101	2,6" × 2,2"
	6,6 × 5,6 cm
	12 in a box



Scraper
Wood Handle

2215	11,8" × 55,1"
	30 × 140 cm
	6 in a box



Scraper
Wood Handle

2213	8" × 53,1"
	20 × 135 cm
	6 in a box



Scraper
(Wide Handle)

2205	11,8" × 9,8"
	30 × 25 cm
	6 in a box



Scraper

2201	2" × 6,3"
	5 × 16 cm
	6 in a box



Scraper

2202	4" × 8"
	10 × 20 cm
	6 in a box



Scraper

2203	8" × 8,3"
	20 × 21 cm
	6 in a box



Scraper

2204	11,8" × 10"
	30 × 25 cm
	6 in a box

Scraper with Blast Pipe 1301

5,1" × 39,4"
13 × 100 cm

Used for removing paints by fire with
LPG tube. It is scraping with 5,1" / 13
cm wide scraper mouth.

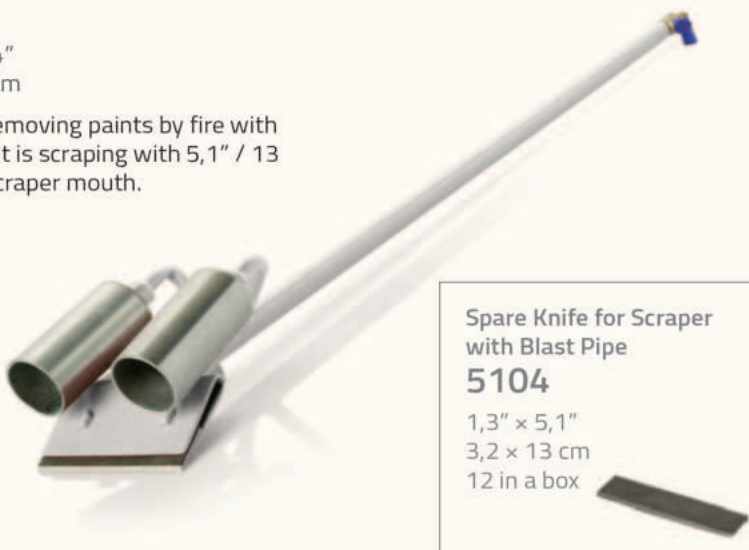

Spare Knife for Scraper
with Blast Pipe
5104

1,3" × 5,1"
3,2 × 13 cm
12 in a box

Code	Dimensions (cm)	Box
1204	6 x 27	12
1211	6 x 30	12
1301	13 x 100	1
1529	4,5 x 27	12
1531	4,5 x 110	6
1532	7 x 29	12
2201	5 x 16	6
2202	10 x 20	6
2203	20 x 21	6
2204	30 x 25	6
2205	30 x 25	6
2213	20 x 135	6
2215	30 x 140	6

Spares

5100	5 x 6	25
5101	6,6 x 5,6	12
5102	2,2 x 7	25
5103	2,2 x 4,5	25
5104	3,2 x 13	12

SANDERS

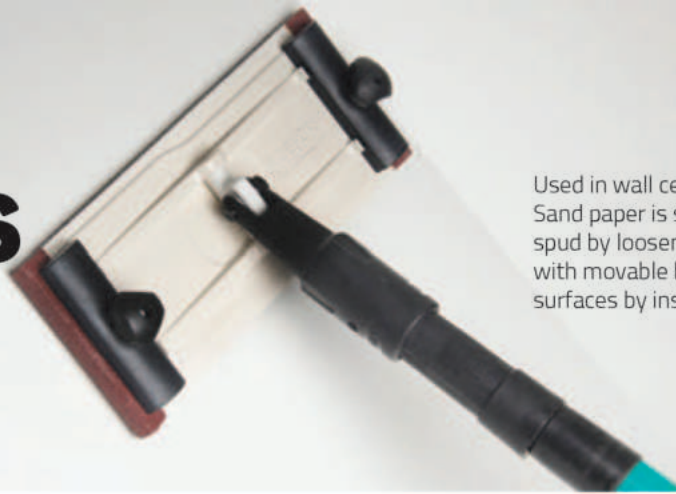

Used in wall ceiling sanding applications. Sand paper is stretched and clamped on the spud by loosening the screws. Sander spud with movable head can reach to difficult surfaces by inserting on the rod end.



Pole Hand Sander

1507	4,5" x 9"
	11,5 / 23 cm
	12 in a box



Pole Hand Sander

1207	3,5" x 8,9"
	9 x 22,5 cm
	12 in a box



Hand Sander

1206	3,5" x 8,9"
	9 x 22,5 cm
	12 in a box

Rubber Hand Sander

1234	2,8" x 8,3"
	7 x 21 cm
	12 in a box

Used in surface sanding applications.



Ergonomic Hand Sander

1235	6" / 15 cm
	12 in a box

Used in surface sanding applications. Easy use due to the ergonomic structure facilitating gripping and applying power. Can be used with both the right and left hand.



Strip Disc Foam

1382	1,8" / 4,5 cm
	25 in a box



Strip Disc Tool

1380	1,8" / 4,5 cm
	12 in a box



Used for polishing chrome surfaces.

Code	Dimensions	Box
1206	3,5" x 8,9" / 9 x 22,5 cm	12
1207	3,5" x 8,9" / 9 x 22,5 cm	12
1507	4,5" x 9" / 11,5 x 23 cm	12
1234	2,8" x 8,3" / 7 x 21 cm	12
1235	6" / 15 cm	12

Strip Disc Tool

1380	1,8" / 4,5 cm	12
1381	2" / 5 cm	12

Strip Disc Foam

1382	1,8" / 4,5 cm	25
1383	2" / 5 cm	25

AERATED CONCRETE PRODUCTS



Aerated Concrete Mixer Head

1522

H: 21,7" D: 4,2"
H: 55 cm D: 10,7 cm
6 in a box



Aerated Miter

2543

10,2"
26 cm
6 in a box



Aerated Concrete Shovel
2544
3,3"
8,5 cm
2 in a box

Code	Lenght	Box
Aerated Concrete Shoveller		
2544	3,3" / 8,5 cm	2
2545	4,1" / 10,5 cm	2
2546	5,3" / 13,5 cm	2
2547	6,1" / 15,5 cm	2
2548	8" / 20,5 cm	2
2549	10" / 25,5 cm	2



Aerated Concrete Trencher

2550

17,7" / 45 cm
4 in a box

Punches are used by using low speed drills without giving harm to the electrical installation.



Aerated Concrete Electric Box Opener

2540

4,9" / 12,5 cm
12 in a box



Aerated Concrete Aspirator Chimney Punch

2541

14,2" / 36 cm
6 in a box



Aerated Concrete Boiler Chimney Punch

2542

14,2" / 36 cm
6 in a box

Code	Lenght	Box
1522	21,7" / 55 cm	6
2540	4,9" / 12,5 cm	12
2541	14,2" / 36 cm	6
2542	14,2" / 36 cm	6
2543	10,2" / 26 cm	6
2550	17,7" / 45 cm	4

! All size included

TROWELS



Silk Plastic Trowel

073	4" × 11"
	10 × 28 cm
	12 in a box

Used for plaster applications on interior surfaces. Produced from acrylic plate and it has plastic handle.



Plastic Trowel

1187	5" × 11"
	12,8 × 28 cm
	12 in a box

For use in Exterior plaster applications. It is produced from acrylic plate.



Stainless Steel
Internal Corner Trowel

1212	12 in a box
-------------	-------------



Stainless Steel
External Corner Trowel

1213	12 in a box
-------------	-------------

Used for the smoothing corners.

Code	Dimensions	Box
073	4"×11" / 10 × 28 cm	12
1187	5"×11" / 12,8 × 28 cm	12
1212	-	12
1213	-	12

SPREADERS

It is used to form flat and smooth surfaces on the areas of application by means of its flexible and silicon structure. It eliminates air bubbles.



Spreader (Thin)
1231
4" / 10 cm
24 in a box



Spreader
1350
2,2" / 5,5 cm
24 in a box



Spreader
1351
2,8" / 7 cm
24 in a box

Big Spreader
(with handle)
1355
4,5" / 11,5 cm
12 in a box



Spreader (with handle)
1353
2,2" / 5,5 cm
12 in a box



Big Spreader
(with handle)
1354
2,8" / 7 cm
12 in a box



Code	Length	Box
1231	4" / 10 cm	24
1350	2,2" / 5,5 cm	24
1351	2,8" / 7 cm	24
1353	2,2" / 5,5 cm	12
1354	2,8" / 7 cm	12
1355	4,5" / 11,5 cm	12

Plastic Rake



1415	19,7"
	50 cm
	6 in a box



1414	13,8"
	35 cm
	6 in a box

Used for in the barn and snow removal application.

1290

Use with Thick Tipped Aluminium Pole (Stable)



1530

Mortar Rake

Used for spreading and collecting mortar and similar materials.

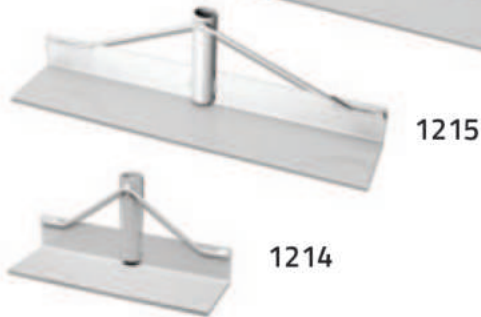

1215



1214

Code	Length	Box
1214	4" x 11,8" / 10 x 30 cm	6
1215	4" x 19,7" / 10 x 50 cm	6
1530	4" x 31,5" / 10 x 80 cm	6

Use with Thick Tipped Aluminium Pole (Stable)



1290	4,92 ft
	1,5 m
	8 in a box



Aluminium Plaster Feather Edge

Used for plaster gauging. It is made of Aluminium and produced in three types for interior, Exterior and purposes. There is different lengths 39,4" / 1 m to 19,68 ft / 6 m.

Code: 1198		Standard
Code: 1199		Inner
Code: 1200		Outer

Code	Type	Height (m)	Width (cm)	Thickness (mm)
1198	Standard	1	11	1,8
1709	Standard	1,5	11	1,8
1710	Standard	2	11	1,8
1711	Standard	2,5	11	1,8
1712	Standard	3	11	1,8
1199	Inner	1	9,8	1,5
1701	Inner	1,5	9,8	1,5
1702	Inner	2	9,8	1,5
1703	Inner	2,5	9,8	1,5
1704	Inner	3	9,8	1,5
1200	Outer	1	11,3	1,5
1705	Outer	1,5	11,3	1,5
1706	Outer	2	11,3	1,5
1707	Outer	2,5	11,3	1,5
1708	Outer	3	11,3	1,5

1198



1199



1200

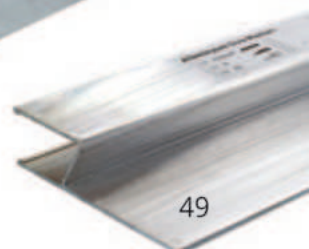

DEKORATIVE

FOAM PAINT ROLLER



Foam Coral Roller

1116	8"
	20 cm
	12 in a box



Foam Roller with Cavities

1117	8"
	20 cm
	12 in a box

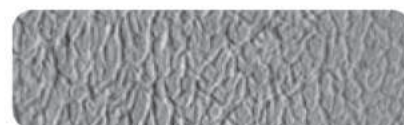

Foam Roller with Naps

1118	8"
	20 cm
	12 in a box

Code	Length	Box
Foam Coral Roller		
1116	8" / 20 cm	12
Foam Coral Roller Sleeve		
1136	8" / 20 cm	25
Foam Roller with Cavities		
1117	8" / 20 cm	12
1129	10" / 25 cm	12
Foam Roller with Cavities Sleeve		
1135	10" / 25 cm	25
Foam Roller with Naps		
1156	19,7" / 50 cm	4
1155	15,7" / 40 cm	4
1154	11,8" / 30 cm	4
1122	10" / 25 cm	12
1118	8" / 20 cm	12
Foam Roller with Naps Sleeve		
1159	19,7" / 50 cm	9
1158	15,7" / 40 cm	9
1157	11,8" / 30 cm	9
1125	10" / 25 cm	25
1124	8" / 20 cm	25
Foam Radiator Roller with Naps		
1123	4" / 10 cm	25
Foam Radiator Roller with Naps Sleeve		
1128	4" / 10 cm	50

Used with acrylic paints on Exterior for decorative purposes.



Foam Roller with Naps

1156	19,7"
	50 cm
	4 in a box



Foam Radiator Roller with Naps

1123	4"
	10 cm
	25 in a box

DECORATIVE PAINTING ROLLERS

For use in decorative paint applications to create figures and patterns on wall and ceiling. Must be applied with special effect roller.

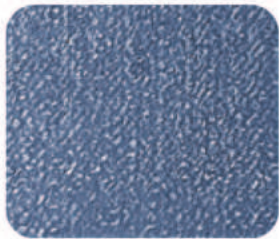

**Thin Effect
Roller**

1346	8"
	20 cm
	2 in a box

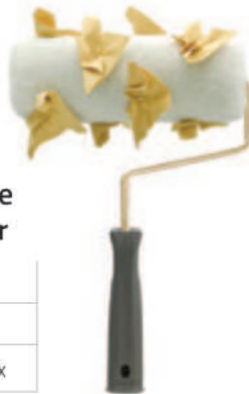

**Leather Rose
Effect Roller**

1321	8"
	20 cm
	2 in a box



Ringed Roller

1550	4,3"
	11 cm
	2 in a box



**Nylon Effect
Roller**

1323	8"
	20 cm
	2 in a box

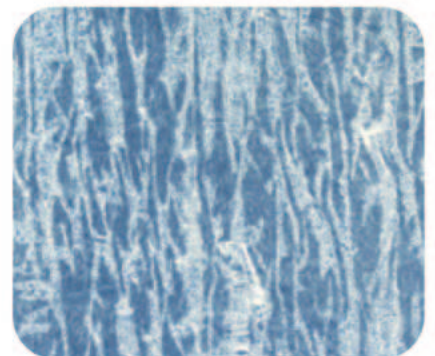

**Leather Effect
Roller**

1320	8"
	20 cm
	2 in a box

Code	Length	Box
1320	8" / 20 cm	2
1321	8" / 20 cm	2
1323	8" / 20 cm	2
1346	8" / 20 cm	2
1550	4,3" / 11 cm	2

DECORATIVE PAINTING TOOLS

For use in decorative paint applications to create figures and patterns on wall and ceiling. Must be applied with special effect roller.

USED WITH SPECIAL EFFECT PAINT.

Leather Rose Effect Tool

1326 / 6" x 2,4" / 15 x 6 cm / 3 in a box



Deep Relief Sponge

1327 / 6" / 15 cm / 4 in a box



Crystal Effect Sponge

1328 / 6" / 15 cm / 4 in a box



9 Stamp Effect Tool

1425 / 5,5" x 5,5" / 14 x 14 cm / 2 in a box



13 Stamp Effect Tool

1325 / 5,5" x 5,5" / 14 x 14 cm / 2 in a box

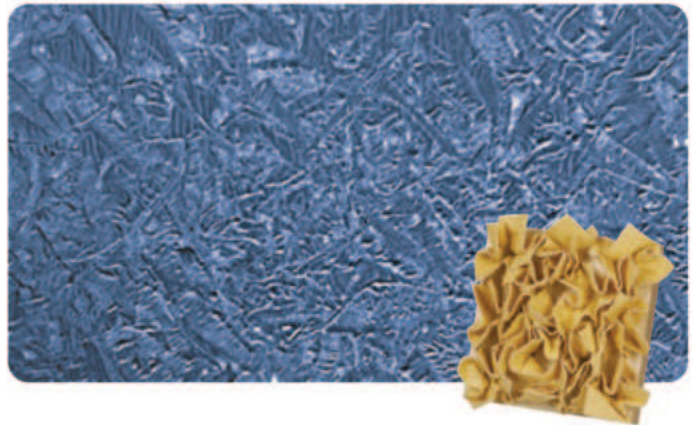

25 Stamp Effect Tool

1341 / 8,7" x 8,7" / 22 x 22 cm / 2 in a box

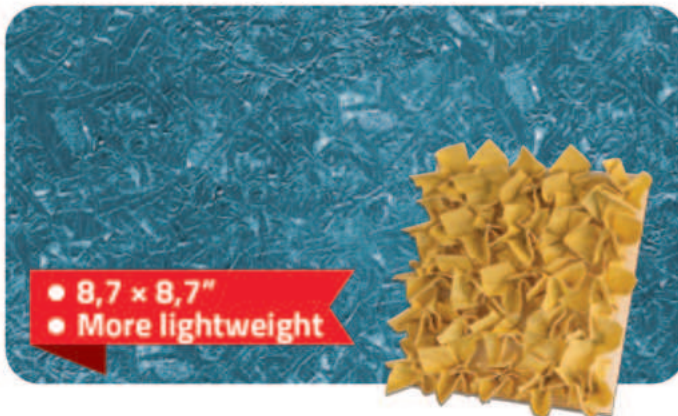

- 8,7" x 8,7"
- More lightweight

36 Stamp Effect Tool

1342 / 10" x 10" / 25 x 25 cm / 2 in a box

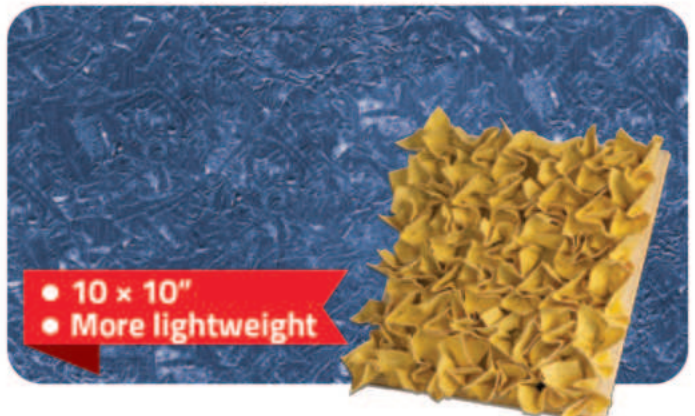

- 10" x 10"
- More lightweight



1344
8" / 20 cm
2 in a box



1347
6" / 15 cm
6 in a box

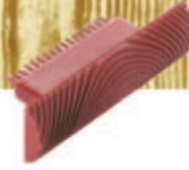

1345
4" / 10 cm
6 in a box

Wood Surface Effect Tool

Code	Length	Box
1344	8" / 20 cm	2
1347	6" / 15 cm	6
1345	4" / 10 cm	6



Effect Spatula
1555 / 4,1" x 6,3"
/ 10,5 x 16 cm / 6 in a box

EFFECT SERIES

APPLICATION

⚠ For having clear figure use effect paint.

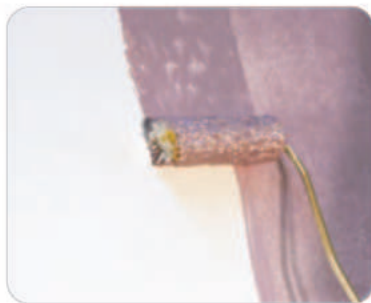

1
Please apply lining paint and wait until it is dry. For not drying up effect paint, wet gently over the lining paint.

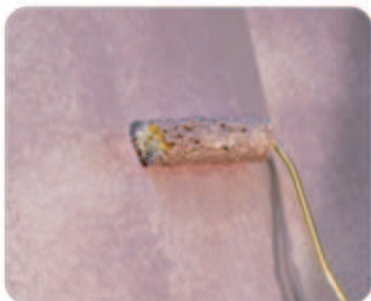

2
Apply the effect paint on the lining. Remove the excessive of paint by using sponge roller.



3
Before the effect paint dry using effect tool you can make figure by pressing the tool on the wall.

MATERIALS REQUIRED

Paint and application for painting background.



Sponge and water for making wet the background.



Effect paint and roller to apply effect for second layer.



Sponge roller for removing the excess of paint.



The tool for the effect to be applied.



First and second layer of paint will appear final touch over your wall. Keep this in mind when choosing colors for each floor. Effects may vary depending on the applied techniques and paint. Before application a good idea to create a test area to experiment.

MACHINES



Whitewash Tank

1300	1305 + 1310 + 19,69 ft / 6 m hose
	1 Box

Used in limewash applications. Tank with a storage of 5 tins of limewash operates with 4 bar pressures. It requires air-compressor connection.

Code	Product	Box
1300	Machine Set	1
1305	Whitewash Tank	1
1310	Whitewash Head	1



1302	Machine Set	1
1303	Tank 10,6 gal. / 40 Lt	1
1304	Spraying Gun	1
1311	Spray Nozzle of Gun	1



Interior Decorate Spraying Machine

1302	1303 + 1304 + 19,69 ft / 6 m hose
	1 Box

Used for internal facade coating or applying the face rite paint on plaster, concrete, gauging plaster, wooden Natural boards and prefabricated surfaces in interior decorations. Creates large and small grains on walls. Requires a set with a 19,69 ft hose and a 10,6 gal. storage tank, and 5 bar compressor connection. Size of the grains can be adjusted using the pressure and paint adjustment valves on the gun.



1306	Complete Set	1
1307	Spraying Gun	1
1308	Tank 0,52 gal. / 2 lt	1



Exterior Surface Acrylic Spraying Gun

1306	1307 + 1308
	1 Box

Used in External decoration applications with paint gun with acrylic External mineral-sanded coating paints. The gun operating with 5-7 bar pressure requires a compressor connection. The gun creates large and small grains on walls. Grain size is adjusted using pressure adjustment screw at the backside of the gun.



PAINT BRUSH STAND

9125

Height: 7,87 ft / 2,4 m

Width: 31,5" / 80 cm

Depth: 21,3" / 54 cm

2 Box + 1 Link

Total 203 product



PAINTER STAND

9121

Height: 7,87 ft / 2,4 m

Width: 31,5" / 80 cm

Depth: 21,3" / 54 cm

3 Box + 1 Link

Total 155 product



SCRAPER STAND

9129

Height: 7,87 ft / 2,4 m

Width: 31,5" / 80 cm

Depth: 21,3" / 54 cm

2 Box + 2 Link

Total 86 product



CLEANING STAND

9132

Height: 7,87 ft / 2,4 m

Width: 31,5" / 80 cm

Depth: 21,3" / 54 cm

2 Box + 2 Link

Total 60 product



rosehantrade.com

RoseBuild



**PRODUCT
CATALOG**