



RoseBuild

rosehantrade.com

Endüstriyel Ekipmanlarda Üretim Çözüm Ortağınız
Your Manufacturing Solution Partner in Industrial Equipments

Ürün Kataloğu
Product Catalogue

Gıda ve Sanayi Kasaları
Baked & Industrial Containers

Taşıma ve Çöp Konteynerleri
Transport & Garbage Containers

Plastik Paletler
Plastic Pallets

Plastik Taşıma Arabaları
Transport Trolleys

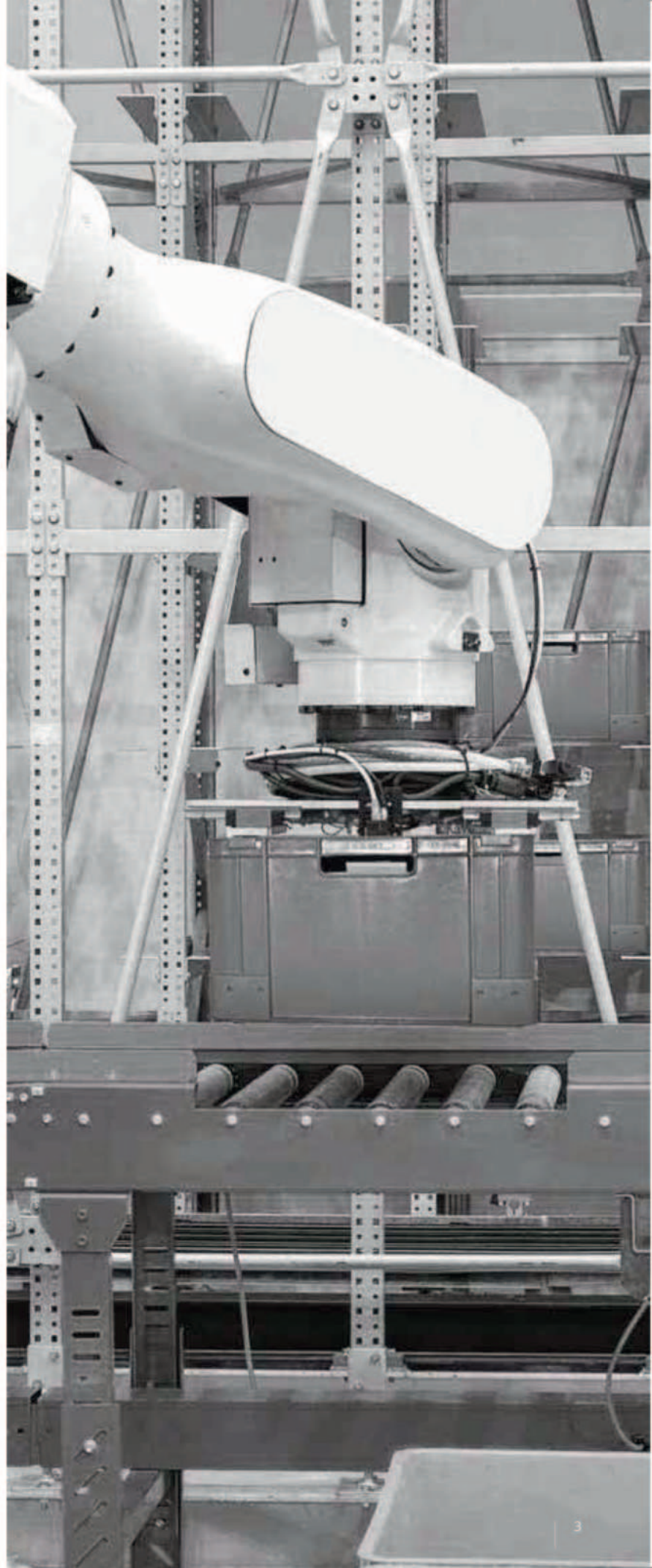

Depolama, taşıma ve
istiflemede
çözüm ortağınız!

*Your solution partner in storage,
transportation and stacking!*

certificates: / sertifikalar





content: / içerik



01

12-19

Taşıma Konteynerleri
Carrying Containers 12-19

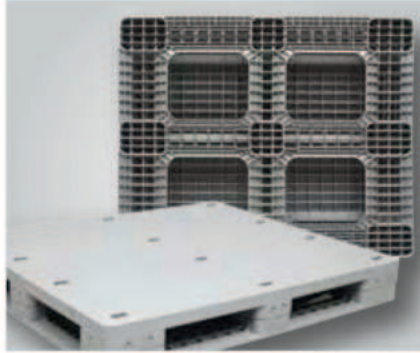

02

22-37

Plastik Paletler 22-37



03

40-43

Unlu Mamül Kasaları
Baked Product Containers 40-41

Sebze Meyve Kasaları
Vegetable & Fruit Crates 42-43



04

46-50

Sanayi Kasaları
Industrial Containers 46-48

Konik Kasalar
Conic Crates 49

Delikli Kasalar
Perforated Containers 50



05

52-57

Çöp Konteynerleri
Garbage Containers

3200 - 660 Lt

52-57



06

60-71

Çöp Konteynerleri
Garbage Containers

360 - 7 Lt

60-71



07

74-84

Bulaşık Sepetleri
Dishwasher Racks

BYRISSE DÖNÜŞÜMÜZ İÇİNİZ
EUORACKS
KUYUN BULAŞIK SİBİNETLERİ

74-85



08

88-90

Taşıma Arabaları
Transport Trolleys

88-90

01

products: / ürünlr



Taşıma Konteynerleri

Carrying Containers

Tekstil, gıda, sebze meyve, sanayi taşıma depolama
istifleme konteynerleri.

*Textile, food, vegetable fruit, industry carrying storage
stacking containers.*

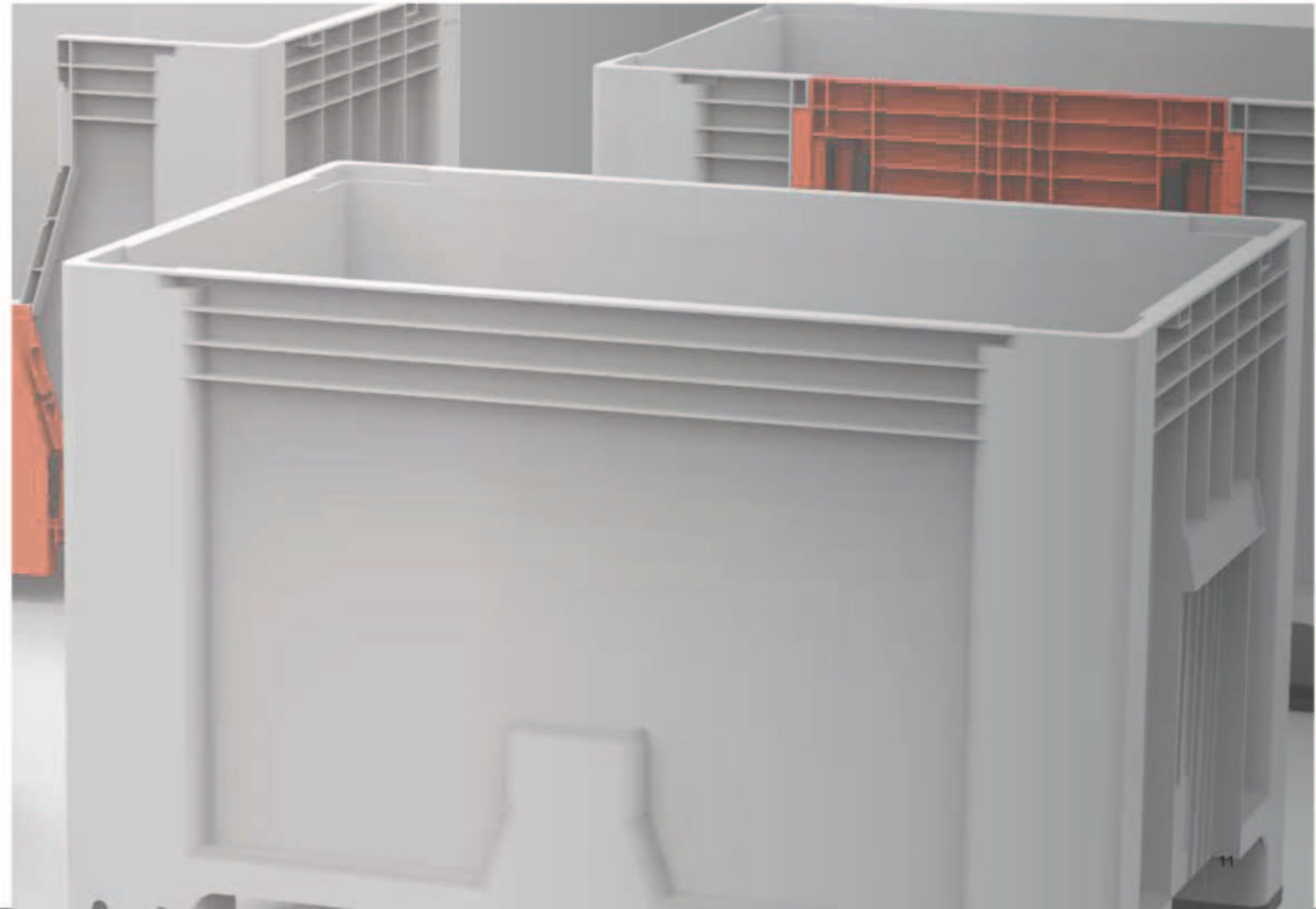

K9000 TAŞIMA KONTEYNERİ**K9000 CARRYING CONTAINER**Renkler
Colors

RAL 7000

RAL 3000

RAL 1018

RAL 6020

RAL 5022



* Özel renk üretim yapılabilir.
** Minimum sipariş detaylarını lütfen sorunuz.

* Special color production is possible.
** Please ask for minimum order details.

Başlıca Özellikler*Main Features*

Enjeksiyon yöntemiyle HDPE hammadde ile üretilmektedir. Kolay temizlenir. Sıcağa, soğuğa, kimyasallara ve UV ışınlarına dayanıklıdır.
It is produced by injection method with HDPE raw material. Easy to clean. It is resistant to heat, cold, chemicals and UV rays.
It saves space with its nesting feature.
Her türlü sektöre uygun geniş ürün çeşidi darbelerle karşı dayanıklıdır.
Wide product range suitable for every sector is resistant to impacts.
30 +70 derece ısı aralığının dışında kullanılmamalıdır.
It should not be used outside the temperature range of 30 + 70 degrees.

- Hijyenik, HACCP sertifikalı modeller.
Hygienic, HACCP certified models.
- Nem, mantar ve böcek barındırmaz.
It does not contain moisture, fungi and insects.
- Doğaya ve çevreye saygılı, geri dönüşümlü.
Respectful to nature and the environment, recyclable.
- Her türlü yüke ve sektöre uygun geniş ürün çeşidi.
A wide range of products suitable for all kinds of loads and sectors.
- Yağ, asit vb. maddelerden etkilenmez.
It is not affected by oil, acid etc.

Ölçüler / Dimensions L x W x H (cm)	Model	Hacim / Volume (lt)	Tır yükleme adedi / Units on truck	40 HC
120 x 80 x 80	K-9000	525	99	78
120 x 81 x 6	K-9000K	525	99	78



K9000 TAŞIMA KONTEYNERİ
K9000 CARRYING CONTAINER

Üst kayar kapak
Sliding top lid



Yandan ürün yüklemeye ve boşaltmaya yarayan menteşeli ve kilitli pratik yan kapak
Practical hinged and locked side cover for side loading and unloading of products

● Alternatif aksesuarlı görünümler
Alternative accessory skins

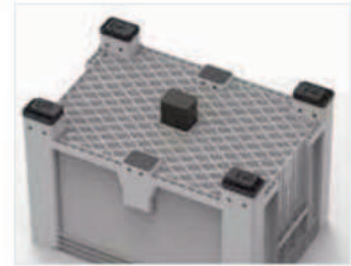
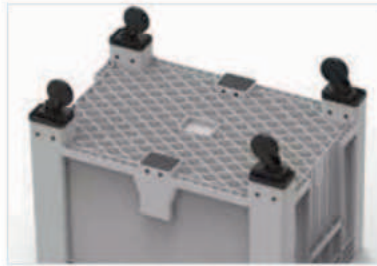

K-9000T TERMOBOX TAŞIMA KONTEYNERİ

K-9000T TERMO CARRYING CONTAINER

Renkler
Colors

RAL 7000
RAL 3000
RAL 1018
RAL 6020
RAL 5022



* Özel renk üretim yapılabilir.
** Minimum sipariş detaylarını lütfen sorunuz.

* Special color production is possible.
** Please ask for minimum order details.

K-7000 TAŞIMA KONTEYNERİ

K-7000 CARRYING CONTAINER

Renkler
Colors

RAL 7000
RAL 3000
RAL 1018
RAL 6020
RAL 5022

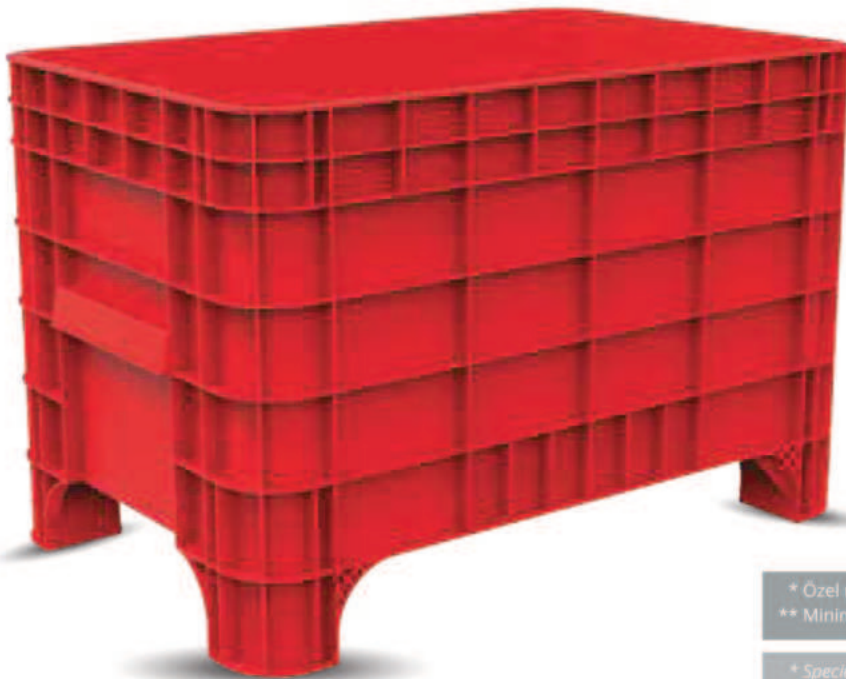

* Özel renk üretim yapılabilir.
** Minimum sipariş detaylarını lütfen sorunuz.

* Special color production is possible.
** Please ask for minimum order details.

K-9000T TERMOBOX TAŞIMA KONTEYNERİ

K-9000T TERMO CARRYING CONTAINER



Isteğe bağlı aktarma musluğu
Faucet can be added (optional)

Başlıca Özellikler *Main Features*

-15 / +75 dereceye kadar 48 saat muhafaza, Paslanmaz çelik kalınlığı 1.2mm, 500 kg taşıma kapasitesi, yıkama ve boşaltma kolaylığı, Hijyenik. Kapak sızdırmaz Menteşeli kilit sistemi / hinged lock system. Üst üst istiflenebilir.
48 hours enclosures down to -15 / +75 degrees, Stainless steel thickness 1.2mm , carrying capacity 500 kg. Ease of washing and emptying, hygienic, Stackable, Liquid proof cover.

Ölçüler / Dimensions L x W xH (cm)	Model	Hacim / Volume (lt)	Tır yükleme adedi / Units on truck	40 HC
120 x 80 x 80	K-9000T	525	99	78
120 x 81 x 6	K-9000T K	525	99	78

**K-7000 TAŞIMA KONTEYNERİ**

K-7000 CARRYING CONTAINER

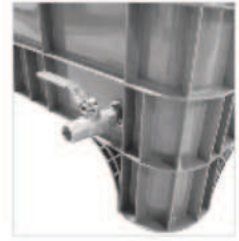

Faucet can be added (optional)
Isteğe bağlı aktarma musluğu

**Başlıca Özellikler** *Main Features*

Enjeksiyon yöntemiyle HDPE hammadde ile üretilmektedir. Kolay temizlenir. Sıcığa, soğuğa, kimyasallara ve UV ışınlarına dayanıklıdır.
It is produced by injection method with HDPE raw material. Easy to clean. It is resistant to heat, cold, chemicals and UV rays.
It saves space with its nesting feature.
Her türlü sektöre uygun geniş ürün çeşidi darbelerle karşı dayanıklıdır.
Wide product range suitable for every sector is resistant to impacts.
30 +70 derece ısı aralığının dışında kullanılmamalıdır.
It should not be used outside the temperature range of 30 + 70 degrees.

Ölçüler / Dimensions L x W xH (cm)	Model	Hacim / Volume (lt)	Tır yükleme adedi / Units on truck	40 HC
99 x 64 x 65	K-7000	270	188	168



K-11000A TAŞIMA KONTEYNERİ

K-11000A CARRYING CONTAINER

Renkler
Colors:

RAL 7000

RAL 3000

RAL 1018

RAL 6020

RAL 5022



* Özel renk üretim yapılabilir.
** Minimum sipariş detaylarını lütfen sorunuz.

* Special color production is possible.
** Please ask for minimum order details.

K-11000 TAŞIMA KONTEYNERİ

K-11000 CARRYING CONTAINER

Renkler
Colors:

RAL 7000

RAL 3000

RAL 1018

RAL 6020

RAL 5022



* Özel renk üretim yapılabilir.
** Minimum sipariş detaylarını lütfen sorunuz.

* Special color production is possible.
** Please ask for minimum order details.

K-11000A TAŞIMA KONTEYNERİ

K-11000A CARRYING CONTAINER



Başlıca Özellikler

Main Features

Enjeksiyon yöntemiyle HDPE hammadde ile üretilmektedir. Kolay temizlenir. Sıcağa, soğuğa, kimyasallara ve UV ışınlarına dayanıklıdır. *It is produced by injection method with HDPE raw material. Easy to clean. It is resistant to heat, cold, chemicals and UV rays. It saves space with its nesting feature.*

Her türlü sektöre uygun geniş ürün çeşidi darbelerle karşı dayanıklıdır. *Wide product range suitable for every sector is resistant to impacts.*

30 +70 derece ısı aralığının dışında kullanılmamalıdır. *It should not be used outside the temperature range of 30 + 70 degrees.*

- Hijyenik, HACCP sertifikalı modeller.
Hygienic, HACCP certified models.
- Nem, mantar ve böcek barındırmaz.
It does not contain moisture, fungi and insects.
- Doğaya ve çevreye saygılı, geri dönüşümlü.
Respectful to nature and the environment, recyclable.
- Her türlü yüke ve sektöre uygun geniş ürün çeşidi.
A wide range of products suitable for all kinds of loads and sectors.
- Yağ, asit vb. maddelerden etkilenmez.
It is not affected by oil, acid etc.

Ölçüler / Dimensions L x W xH (cm)	Model	Hacim / Volume (lt)	Tır yüklemesi adedi / Units on truck	40 HC
100 x 120 x 77,5	K-11000A	670	128	104



K-11000 TAŞIMA KONTEYNERİ

K-11000 CARRYING CONTAINER



Tahliye Deliği
Drain Hole

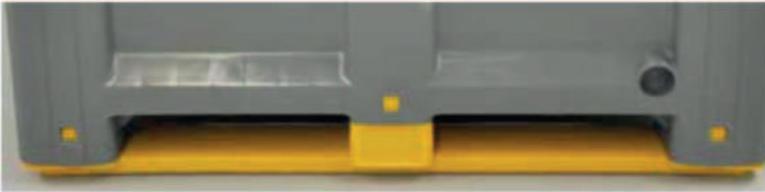

Kızak ayak opsiyonu
Sliding foot option



Önden açılır kapak opsiyonu
Front opening option

Ölçüler / Dimensions L x W xH (cm)	Model	Hacim / Volume (lt)	Tır yüklemesi adedi / Units on truck	40 HC
120 x 100 x 77,5	K-11000	670	128	104



100 x 120 KATLANIR TAŞIMA KONTEYNERİ

100 x 120 FOLDABLE CARRYING CONTAINER

Renkler
Colors

RAL 7000

RAL 3000

RAL 1018

RAL 6020

RAL 5022



X-Y TAŞIMA KONTEYNERİ

X-Y CARRYING CONTAINER

Renkler
Colors

RAL 7000

RAL 3000

RAL 1018

RAL 6020

RAL 5022



* Bu ürünün tedarikçi firmasıyız.
** Minimum sipariş detaylarını lütfen sorunuz.

* We Are the Supplier of This Product.
** Please ask for minimum order details.

100 x 120 KATLANIR TAŞIMA KONTEYNERİ

100 x 120 FOLDABLE CARRYING CONTAINER

Palet kilit opsiyonu
Pallet lock option**Başlıca Özellikler** *Main Features*

Enjeksiyon yöntemiyle HDPE hammadde ile üretilmektedir. Kolay temizlenir. Sıcağa, soğuğa, kimyasallara ve UV ışınlarına dayanıklıdır. *It is produced by injection method with HDPE raw material. Easy to clean. It is resistant to heat, cold, chemicals and UV rays.*

It saves space with its nesting feature. Her türlü sektöre uygun geniş ürün çeşidi darbelerle karşı dayanıklıdır. *Wide product range suitable for every sector is resistant to impacts.*

30 +70 derece ısı aralığının dışında kullanılmamalıdır. *It should not be used outside the temperature range of 30 + 70 degrees.*

** Minimum 500 adet ve üzeri siparişlerde yükseklik istenilen ölçüye göre yapılır. *For orders of minimum 500 pieces or more, height is made according to the desired size.*

Ölçüler / Dimensions L x W xH (cm)	Model
120 x 100 x 75	KPT100120
120 x 80 x 75	KPT 80120

**X-Y TAŞIMA KONTEYNERİ**

X-Y CARRYING CONTAINER



180 derece döndürerek içiçe girebilir yada üstüste durabilirler.

They can intertwine or stand on top of each other by rotating them 180 degrees.

Başlıca Özellikler*Main Features*

Enjeksiyon yöntemiyle HDPE hammadde ile üretilmektedir. Kolay temizlenir. Sıcağa, soğuğa, kimyasallara ve UV ışınlarına dayanıklıdır. *It is produced by injection method with HDPE raw material. Easy to clean. It is resistant to heat, cold, chemicals and UV rays. It saves space with its nesting feature.*

Her türlü sektöre uygun geniş ürün çeşidi darbelerle karşı dayanıklıdır. *Wide product range suitable for every sector is resistant to impacts.*

30 +70 derece ısı aralığının dışında kullanılmamalıdır. *It should not be used outside the temperature range of 30 + 70 degrees.*

Ölçüler / Dimensions L x W xH (cm)	Model	Hacim / Volume (lt)	Yük-Birim (kg) / Load-Unit (kg)	İstiflenmiş Yük Stacking Load
120 x 100 x 78,4	K-12000	525	600	3200



products: / ürünler

02

Plastik Paletler

Plastic Pallets

Taşıma, depolama ve istiflemeye endüstriyel hijyenik paletler.

Industrial hygienic pallets for transport, storage and stacking.

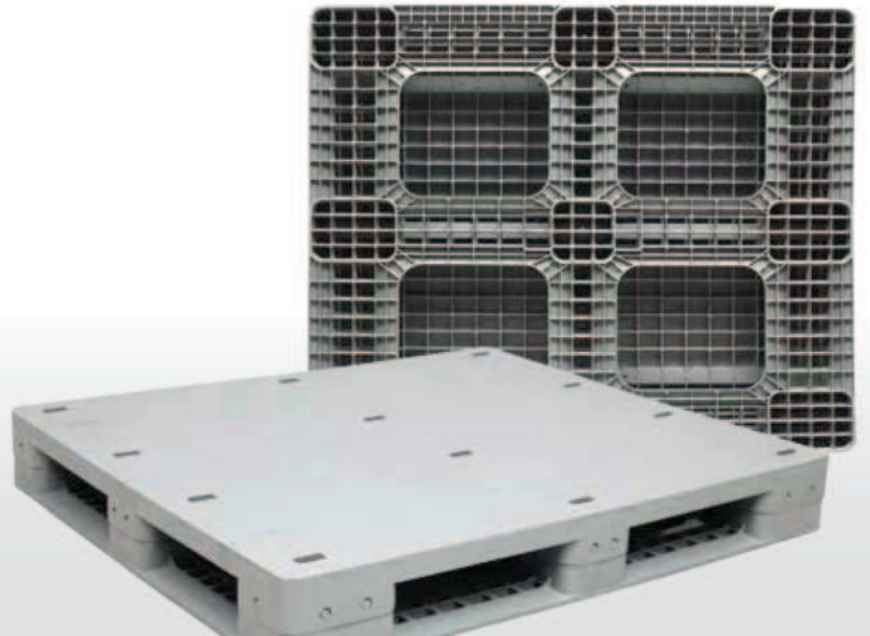

80 x 120 MONOBLOK KAPALI PALETLER

80 X 120 MONOBLOCK SOLID PALLETS

Renkler
Colors

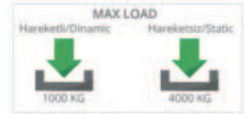

İsteğe bağlı olarak taşıma kapasitesi artırılabilir.
The loading capacity can be increased optionally.

80 x 120 MONOBLOK DELİKLİ PALETLER

80 X 120 MONOBLOCK PERFORATED PALLETS

Renkler
Colors

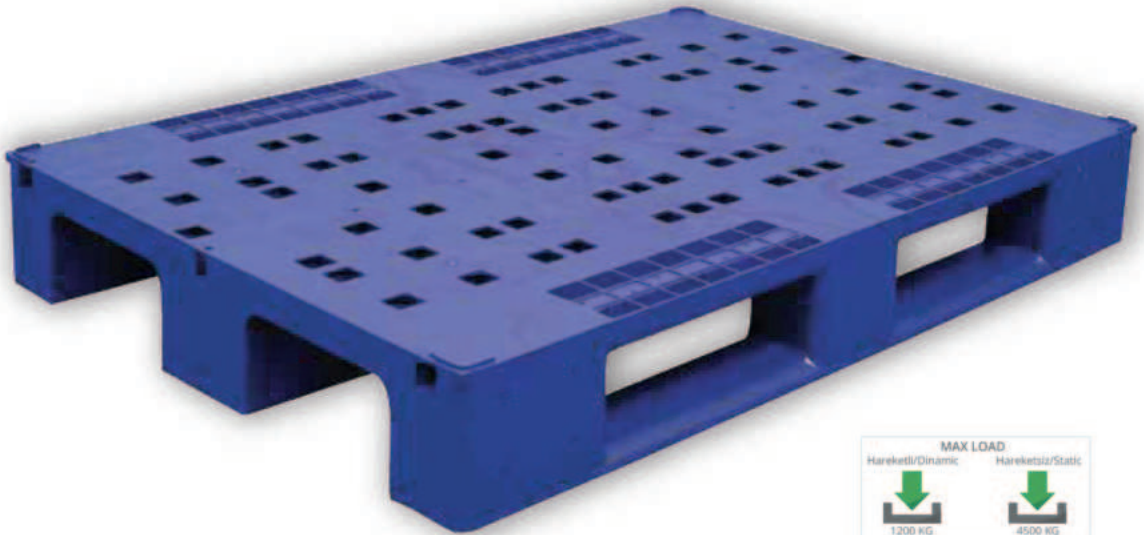

İsteğe bağlı olarak taşıma kapasitesi artırılabilir.
The loading capacity can be increased optionally.

* Özel renk üretim yapılabilir.
** Minimum sipariş detaylarını lütfen sorunuz.

* Special color production is possible.
** Please ask for minimum order details.

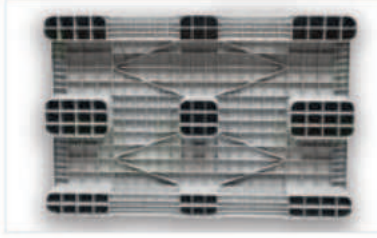
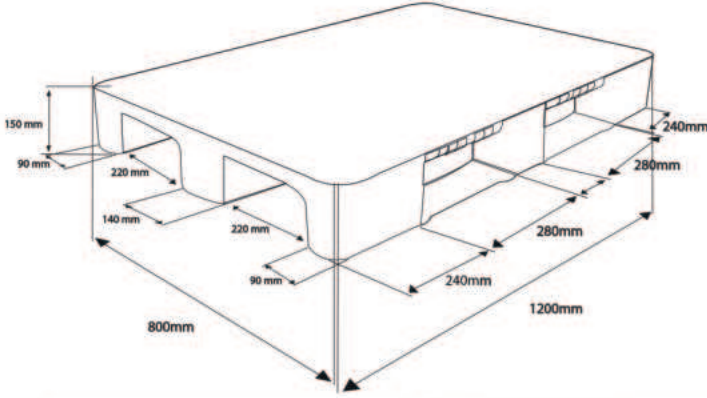
80 x 120 MONOBLOK KAPALI PALETLER**80 X 120 MONOBLOCK SOLID PALLETS****Başlıca Özellikler** *Main Features*

Ürünlerimiz elektrikleme karşıtı antistatik toz itici kimyasallar içermektedir.

Asit, yağ ve gazlardan etkilenmez. Üretim hatalarından kaynaklanan ürünler 3 yıl garantilidir.

Our products contain antistatic, antistatic dust repellent chemicals.

It is not affected by acid, oil and gases. Products caused by manufacturing faults are guaranteed for 3 years.

Ölçüler Dimensions L x W (cm)	Model	Tır yükleme adedi Units on truck	40 HC
120 x 80 x 14,5	KPTK-80120	756	594

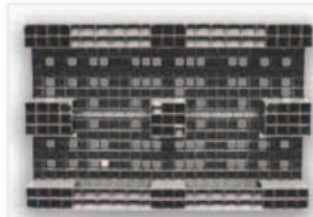
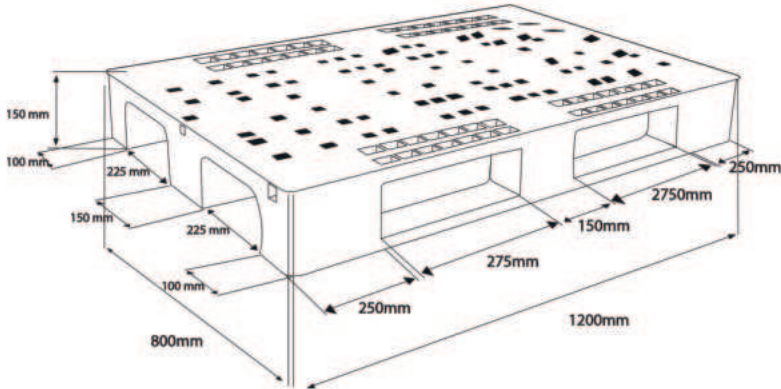
**80 x 120 MONOBLOK DELİKLİ PALETLER****80 X 120 MONOBLOCK PERFORATED PALLETS**

- Hijyenik, HACCP sertifikalı modeller.
Hygienic, HACCP certified models.
- Nem, mantar ve böcek barındırmaz.
It does not contain moisture, fungi and insects.
- Doğaya ve çevreye saygılı, geri dönüşümlü.
Respectful to nature and the environment, recyclable.
- Her türlü yüke ve sektöre uygun geniş ürün çeşidi.
A wide range of products suitable for all kinds of loads and sectors.

Ölçüler Dimensions L x W (cm)	Model	Tır yükleme adedi Units on truck	40 HC
120 x 80 x 16	KPTA-80120	528	400



80 x 120 OTOMATİK DEPO AKILLI RAF PALETİ KAPALI

80 X 120 SMART SYSTEM WAREHOUSE PALLET SOLID

Renkler
Colors



** İsteğe bağlı olarak taşıma kapasitesi artırılabilir.
The loading capacity can be increased optionally.

80 x 120 OTOMATİK DEPO AKILLI RAF PALETİ DELİKLİ

80 X 120 SMART SYSTEM WAREHOUSE PALLET PERFORATED

Renkler
Colors

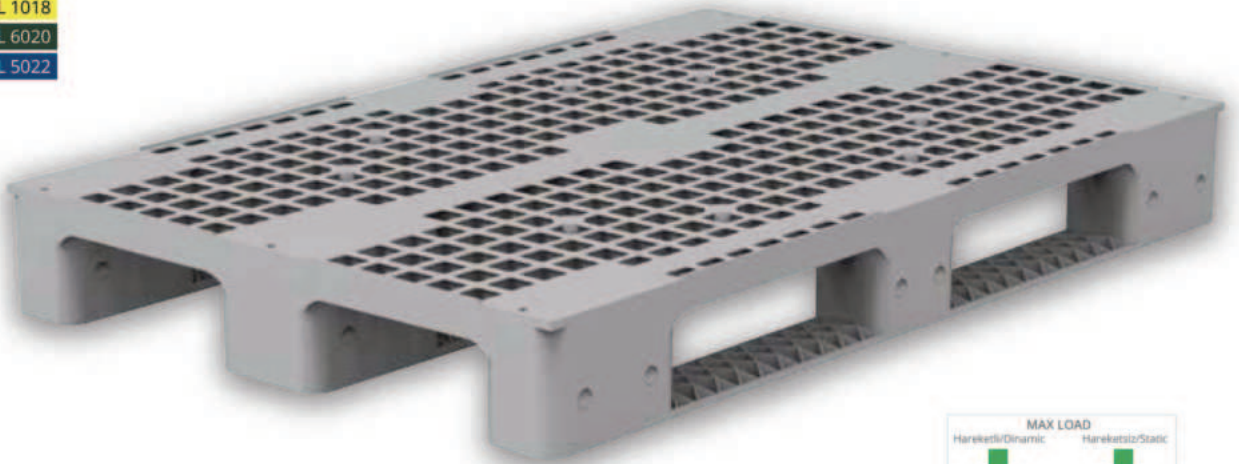

** İsteğe bağlı olarak taşıma kapasitesi artırılabilir.
The loading capacity can be increased optionally.

* Özel renk üretim yapılabilir.
** Minimum sipariş detaylarını lütfen sorunuz.

* Special color production is possible.
** Please ask for minimum order details.

80 x 120 OTOMATİK DEPO AKILLI RAF PALETİ KAPALI

80 X 120 SMART SYSTEM WAREHOUSE PALLET SOLID

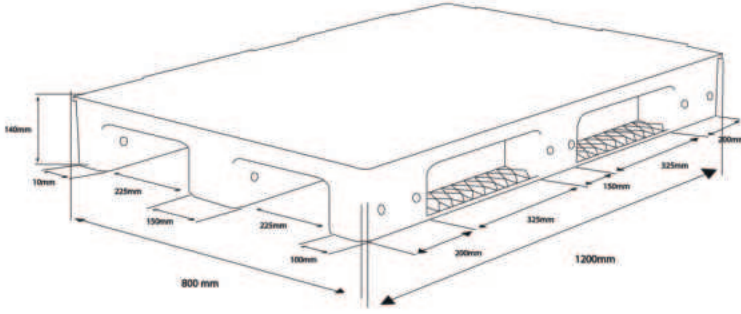
**Başlıca Özellikler** *Main Features*

Ürünlerimiz elektriklenme karşıtı antistatik toz itici kimyasallar içermektedir. Asit, yağ ve gazlardan etkilenmez. Üretim hatalarından kaynaklanan ürünler 3 yıl garantilidir. *Our products contain antistatic, antistatic dust repellent chemicals. It is not affected by acid, oil and gases. Products caused by manufacturing faults are guaranteed for 3 years.*

Ölçüler Dimensions L x W x H (cm)	Model	Tır yükleme adedi Units on truck	40 HC
120 x 80 x 14,5	A-KPTK-80120	756	594

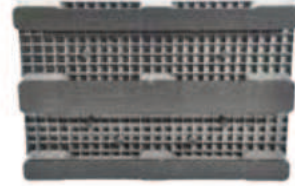

80 x 120 OTOMATİK DEPO AKILLI RAF PALETİ DELİKLİ

80 X 120 SMART SYSTEM WAREHOUSE PALLET PERFORATED

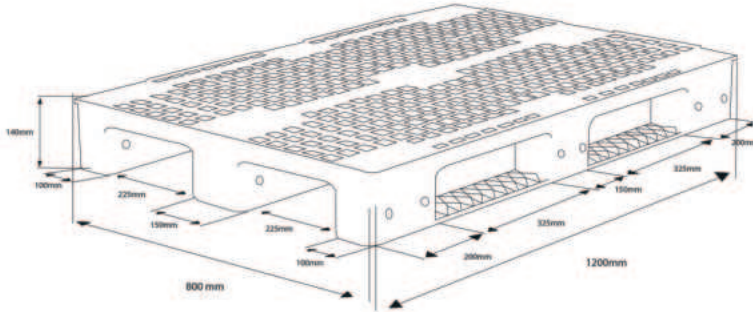

- Otomatik depo dijital sensör sistemine uygun
Suitable for automatic warehouse digital sensor system
- Palet kenar sıralama ve streç tutucu özelliği
Pallet edge sorting and stretch holder feature
- Forkliftte kaymayı önleyici tıplar ve tıpa ayak seçeneği
Anti-slip plugs and plug feet option on the forklift
- Kaymayı engelleyici alt kızak yüzeyi ve profil seçeneği
Anti-slip bottom skid surface and profile option and sectors.

Ölçüler Dimensions L x W x H (cm)	Model	Tır yükleme adedi Units on truck	40 HC
120 x 80 x 14,5	A-KPTA-80120	756	594



80 x 120 ENDÜSTRİYEL PALET KAPALI

KPOW 80 X 120 INDUSTRIAL PALLET SOLID

Renkler
Colors

- RAL 7000
- RAL 3000
- RAL 1018
- RAL 6020
- RAL 5022

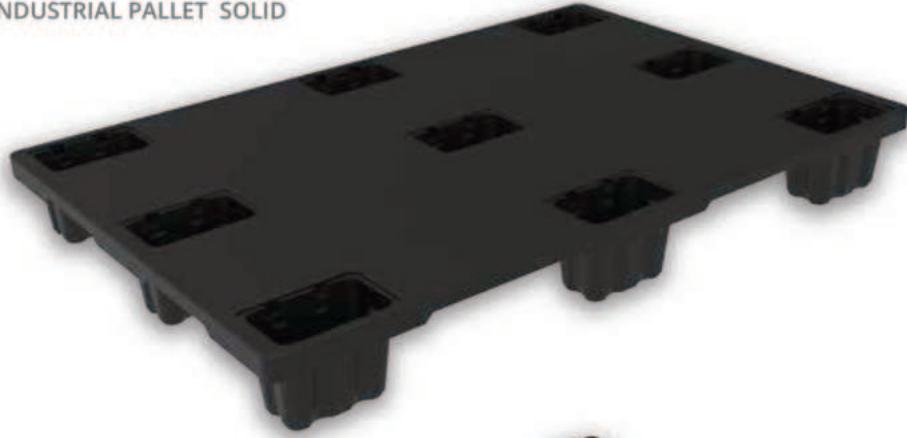

MAX LOAD	
Hareketli/Dynamic	Hareketsiz/Static
	
1000 KG	4000 KG

**** İsteğe bağlı olarak taşıma kapasitesi artırılabilir.**
The loading capacity can be increased optionally.



80 x 120 ENDÜSTRİYEL PALET DELİKLİ

POWA 80 x 120 INDUSTRIAL PALLET PERFORATED

Renkler
Colors

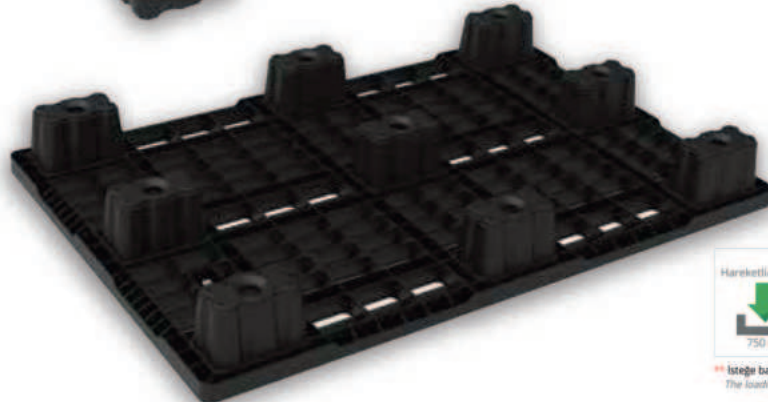
- RAL 7000
- RAL 3000
- RAL 1018
- RAL 6020
- RAL 5022



MAX LOAD	
Hareketli/Dynamic	Hareketsiz/Static
	
750 KG	2000 KG

**** İsteğe bağlı olarak taşıma kapasitesi artırılabilir.**
The loading capacity can be increased optionally.

* Özel renk üretim yapılabilir.
** Minimum sipariş detaylarını lütfen sorunuz.

* Special color production is possible.
** Please ask for minimum order details.

80 x 120 ENDÜSTRİYEL PALET KAPALI

KPOW 80 X 120 INDUSTRIAL PALLET SOLID

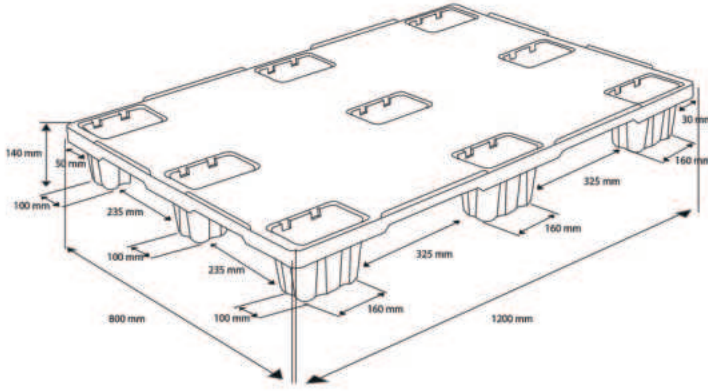
**Başlıca Özellikler** *Main Features*

Ihracat Yöntemlerine Uygun / Suitable For Export Methods
 Otomatik Depo Yapısına Uygun / Suitable for Automatic Warehouse Structure
 Soğuk Hava Depolarına Uygun / Suitable for Cold Storage
 USDA, FDA, ISPM15 Yönetmeliklerine Uygun / Complies With USDA, FDA, ISPM 15 Regulations
 Kaymaz Taban Üst Yapı / Non-Slip Base Upper Structure
 Temiz ve Hijyenik / Clean and Hygienic
 İstiflenebilir / Stackable

Ölçüler Dimensions L x W x H (cm)	Model	Tır yükleme adedi Units on truck	40 HC
120 x 80 x 14	KPOW-80120	2650	2000

**80 x 120 ENDÜSTRİYEL PALET DELİKLİ**

POWA 80 x 120 INDUSTRIAL PALLET PERFORATED

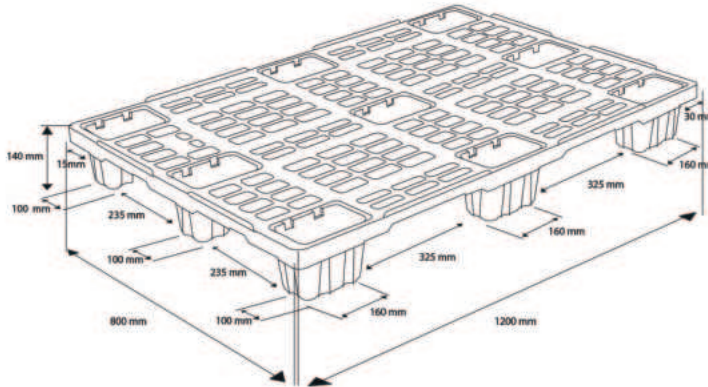
**Başlıca Özellikler** *Main Features*

Ihracat Yöntemlerine Uygun / Suitable For Export Methods
 Otomatik Depo Yapısına Uygun / Suitable for Automatic Warehouse Structure
 Soğuk Hava Depolarına Uygun / Suitable for Cold Storage
 USDA, FDA, ISPM15 Yönetmeliklerine Uygun / Complies With USDA, FDA, ISPM 15 Regulations
 Kaymaz Taban Üst Yapı / Non-Slip Base Upper Structure
 Temiz ve Hijyenik / Clean and Hygienic
 İstiflenebilir / Stackable

Ölçüler Dimensions L x W x H (cm)	Model	Tır yükleme adedi Units on truck	40 HC
120 x 80 x 14	POWA-80120	2650	2000



80 x 120 AKILLI ENDÜSTRİYEL OPSİYONEL PALET KAPALI

80 X 120 SMART OPTIONAL INDUSTRIAL PALLET SOLID

Renkler
Colors

- RAL 7000
- RAL 3000
- RAL 1018
- RAL 6020
- RAL 5022

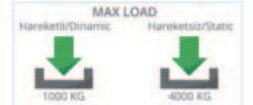
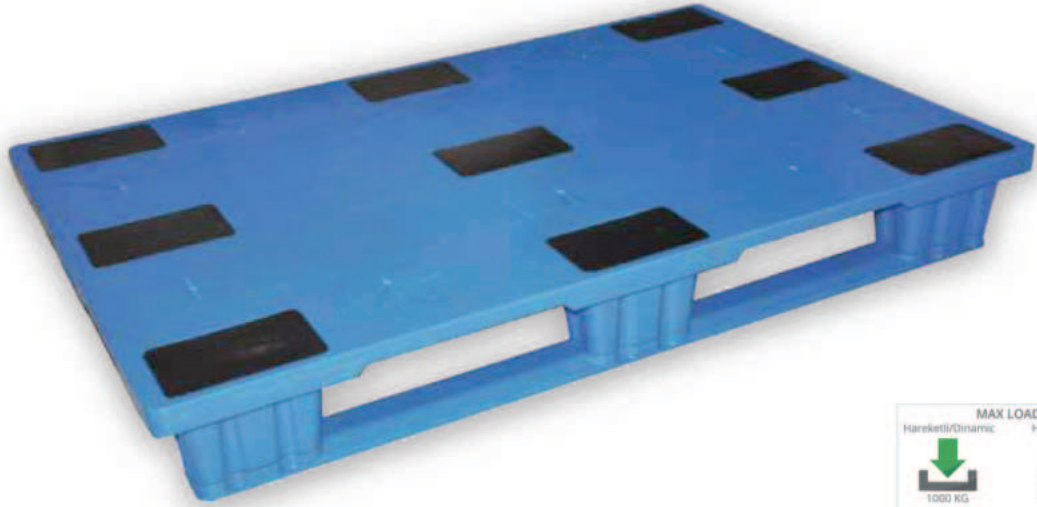

** İsteğe bağlı olarak taşıma kapasitesi artırılabilir.
The loading capacity can be increased optionally.

Ölçüler Dimensions L x W x H (cm)	Model	Tır yükleme adedi Units on truck	40 HC
120 x 80 x 15	KPOW80x120	2650	2000



100 x 120 AKILLI ENDÜSTRİYEL OPSİYONEL PALET DELİKLİ

100 X 120 SMART OPTIONAL INDUSTRIAL PALLET PERFORATED

Renkler
Colors

- RAL 7000
- RAL 3000
- RAL 1018
- RAL 6020
- RAL 5022

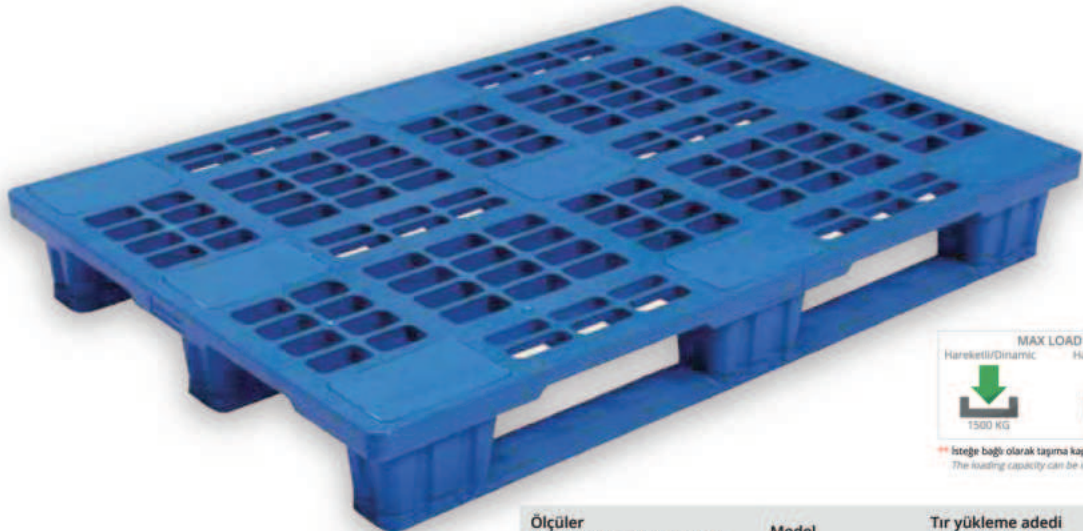

** İsteğe bağlı olarak taşıma kapasitesi artırılabilir.
The loading capacity can be increased optionally.

Ölçüler Dimensions L x W x H (cm)	Model	Tır yükleme adedi Units on truck	40 HC
120 x 100 x 15	KPOWA100120	459	408



* Özel renk üretim yapılabilir.
** Minimum sipariş detaylarını lütfen sorunuz.

* Special color production is possible.
** Please ask for minimum order details.

80 x 120 AKILLI ENDÜSTRİYEL OPSİYONEL PALET 30 MM KANALLI KAPALI

80 X 120 SMART OPTIONAL INDUSTRIAL PALLET WITH 30 MM DUCT SOLID

Renkler
Colors

- RAL 7000
- RAL 3000
- RAL 1018
- RAL 6020
- RAL 5022

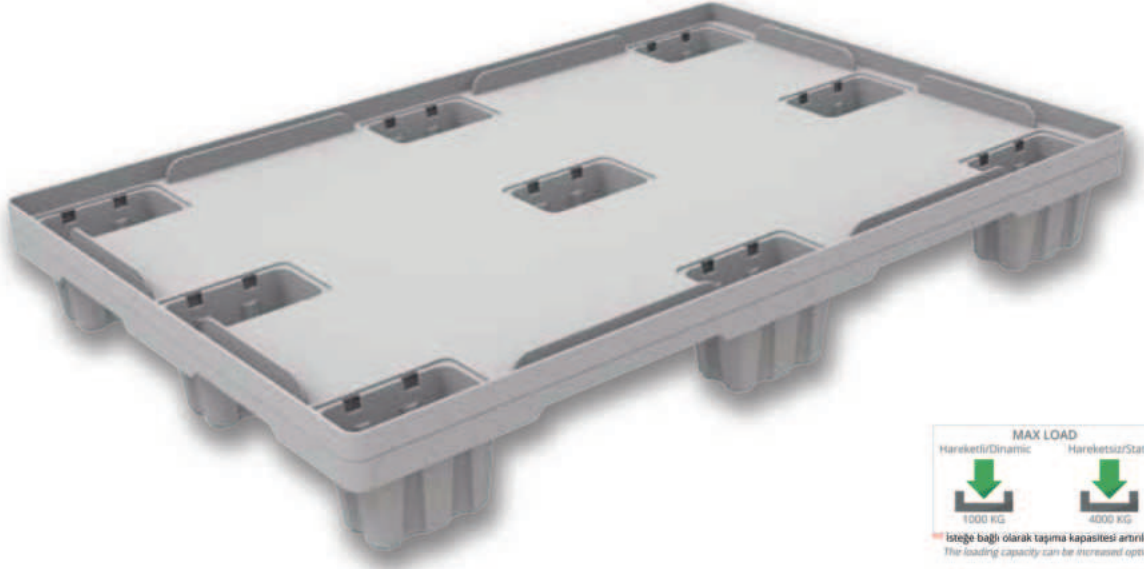

Ölçüler Dimensions L x W x H (cm)	Model	Tır yükleme adedi Units on truck	40 HC
120 x 80 x 17	SPOW80120	2650	2000



100 x 120 AKILLI ENDÜSTRİYEL OPSİYONEL PALET 30 MM KANALLI DELİKLİ

100 X 120 SMART OPTIONAL INDUSTRIAL PALLET PERFORATED

Renkler
Colors

- RAL 7000
- RAL 3000
- RAL 1018
- RAL 6020
- RAL 5022

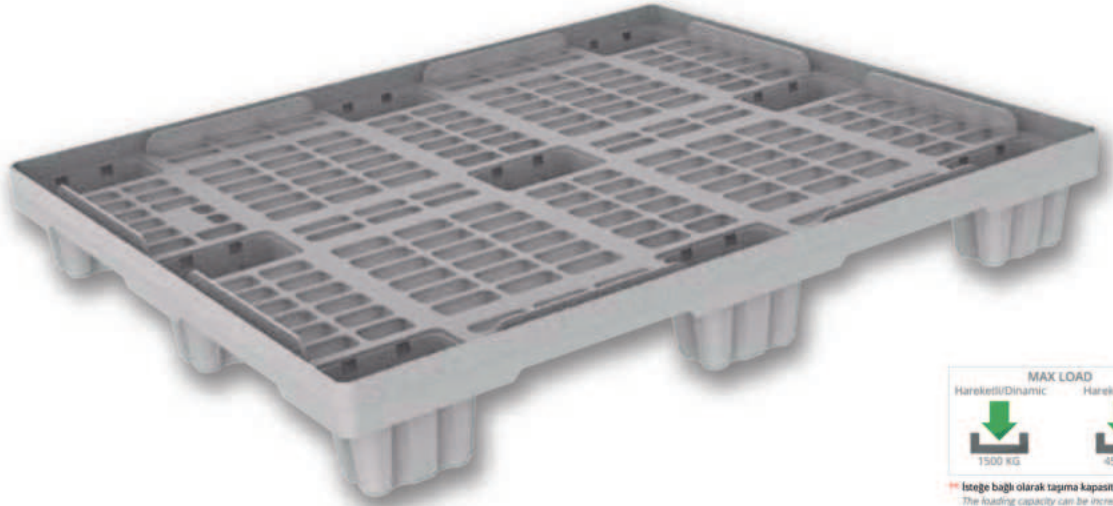

Ölçüler Dimensions L x W x H (cm)	Model	Tır yükleme adedi Units on truck	40 HC
120 x 100 x 17	SPOWA-80120	459	408



100 x 120 OTOMATİK DEPO AKILLI RAF PALETİ KAPALI

100 x 120 SMART SYSTEM WAREHOUSE PALLET SOLID

Renkler
Colors

RAL 7000
RAL 3000
RAL 1018
RAL 6020
RAL 5022



MAX LOAD	
Hareketli/Dinamic	Hareketsiz/Static
1500 KG	4500 KG

** İsteğe bağlı olarak taşıma kapasitesi artırılabilir.
The loading capacity can be increased optionally.

100 x 120 OTOMATİK DEPO AKILLI RAF PALETİ DELİKLİ

100 x 120 SMART SYSTEM WAREHOUSE PALLET PERFORATED

Renkler
Colors

RAL 7000
RAL 3000
RAL 1018
RAL 6020
RAL 5022



MAX LOAD	
Hareketli/Dinamic	Hareketsiz/Static
1500 KG	4500 KG

** İsteğe bağlı olarak taşıma kapasitesi artırılabilir.
The loading capacity can be increased optionally.

* Özel renk üretim yapılabilir.
** Minimum sipariş detaylarını lütfen sorunuz.

* Special color production is possible.
** Please ask for minimum order details.

100 x 120 OTOMATİK DEPO AKILLI RAF PALETİ KAPALI

100 x 120 SMART SYSTEM WAREHOUSE PALLET SOLID

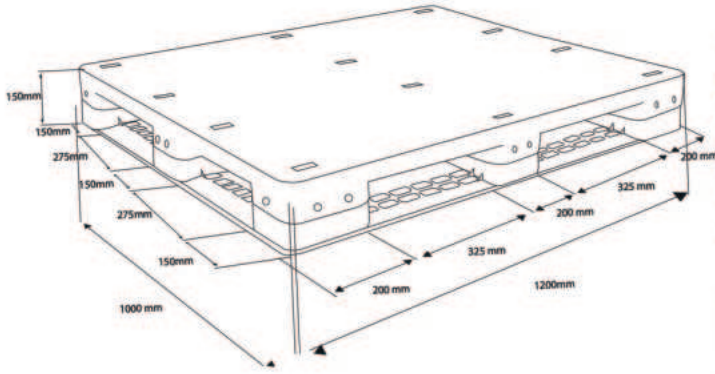
**Başlıca Özellikler** *Main Features*

Ürünlerimiz elektrikleme karşıtı antistatik toz itici kimyasallar içermektedir. Asit, yağ ve gazlardan etkilenmez. Üretim hatalarından kaynaklanan ürünler 3 yıl garantilidir.

Our products contain antistatic, antistatic dust repellent chemicals. It is not affected by acid, oil and gases. Products caused by manufacturing faults are guaranteed for 3 years.

Ölçüler Dimensions L x W x H (cm)	Model	Tır yükleme adedi Units on truck	40 HC
120 x 100 x 14,5	A-KPTK-100120	459	408

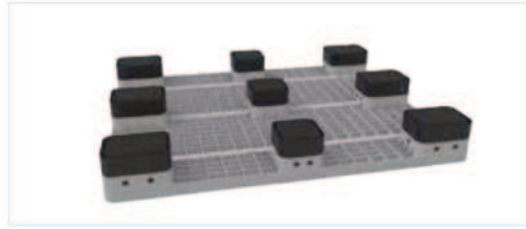
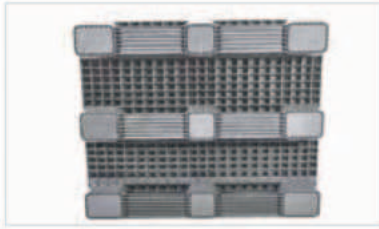

100 x 120 OTOMATİK DEPO AKILLI RAF PALETİ DELİKLİ

100 x 120 SMART SYSTEM WAREHOUSE PALLET PERFORATED

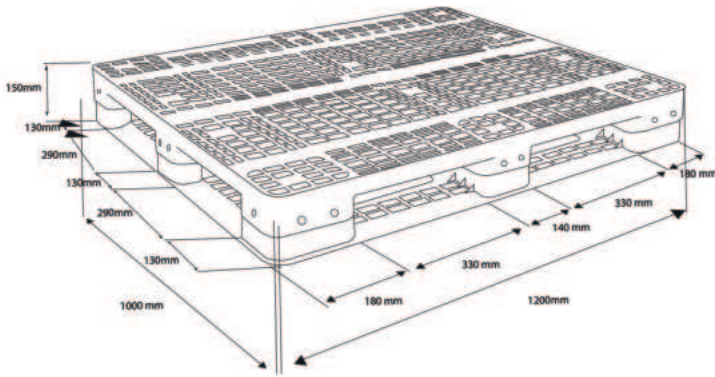

- Otomatik depo dijital sensör sistemine uygun
Suitable for automatic warehouse digital sensor system
- Palet kenar sıralama ve streç tutucu özelliği
Pallet edge sorting and stretch holder feature
- Forkliftte kaymayı önleyici tıplar ve tıpa ayak seçeneği
Anti-slip plugs and plug feet option on the forklift
- Kaymayı engelleyici alt kızak yüzeyi ve profil seçeneği
Anti-slip bottom skid surface and profile option and sectors.

Ölçüler Dimensions L x W x H (cm)	Model	Tır yükleme adedi Units on truck	40 HC
120 x 100 x 14,5	A-KPTA-100120	459	408

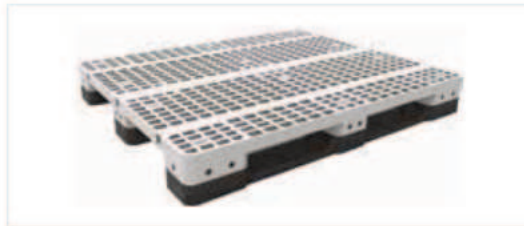

100 x 120 ENDÜSTRİYEL PALET SOLID

KPOW 100 x 120 INDUSTRIAL PALLET SOLID

Renkler
Colors

RAL 7000
RAL 3000
RAL 1018
RAL 6020
RAL 5022

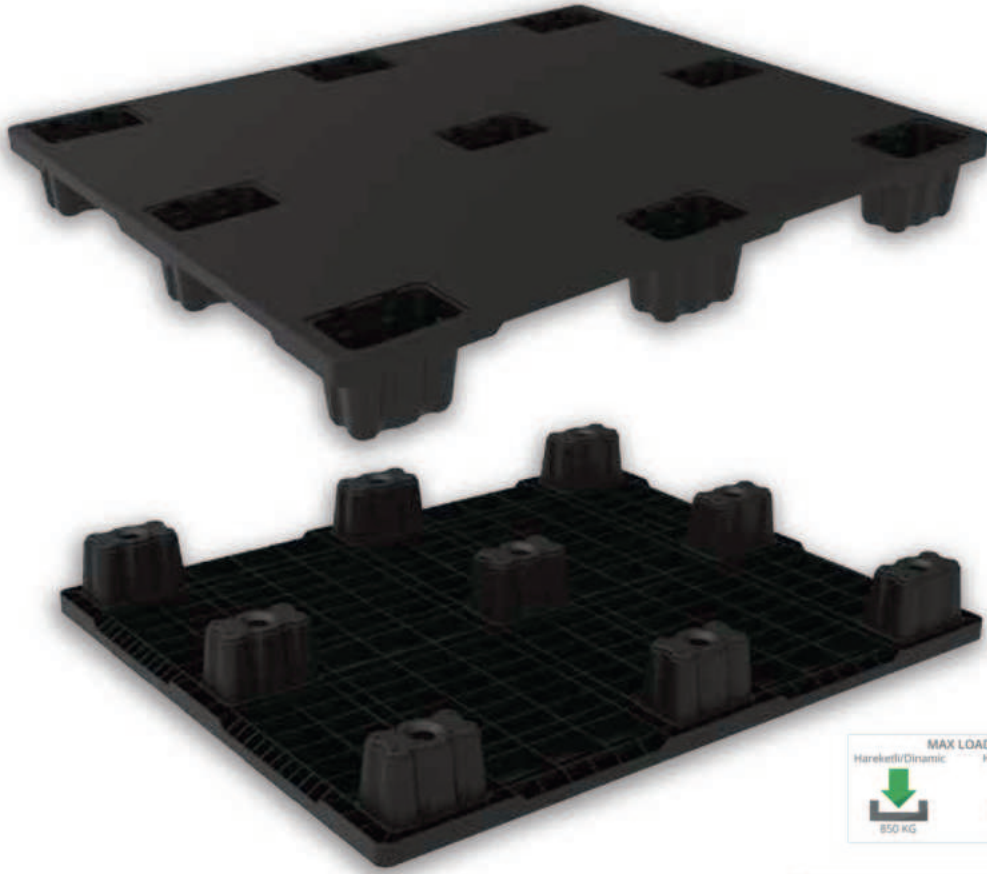

MAX LOAD	
Hareketli/Dynamic	Hareketsiz/Static
850 KG	2500 KG

100 x 120 ENDÜSTRİYEL PALET DELİKLİ

POW 100 x 120 INDUSTRIAL PALLET PERFORATED

Renkler
Colors

RAL 7000
RAL 3000
RAL 1018
RAL 6020
RAL 5022



MAX LOAD	
Hareketli/Dynamic	Hareketsiz/Static
850 KG	2500 KG

* Özel renk üretim yapılabilir.
** Minimum sipariş detaylarını lütfen sorunuz.

* Special color production is possible.
** Please ask for minimum order details.

100 x 120 ENDÜSTRİYEL PALET SOLID

KPOW 100 x 120 INDUSTRIAL PALLET SOLID

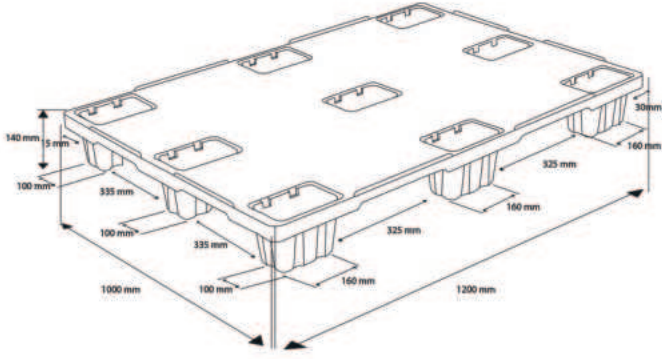

Başlıca Özellikler *Main Features*

İhracat Yöntemlerine Uygun / Suitable For Export Methods
 Otomatik Depo Yapısına Uygun / Suitable for Automatic Warehouse Structure
 Soğuk Hava Depolarına Uygun / Suitable for Cold Storage
 USDA, FDA, ISPM15 Yönetmeliklerine Uygun / Complies With USDA, FDA, ISPM 15 Regulations
 Kaymaz Taban Üst Yapı / Non-Slip Base Upper Structure
 Temiz ve Hijyenik / Clean and Hygienic
 İstiflenebilir / Stackable

Ölçüler / Dimensions L x W x H (cm)	Model	Tır yükleme adedi / Units on truck	40 HC
120 x 100 x 14	KPOW-100120	2450	1800

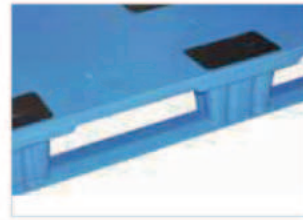
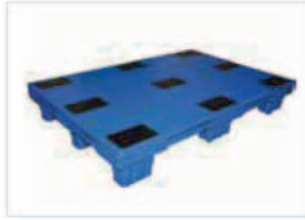

100 x 120 ENDÜSTRİYEL PALET DELİKLİ

POW 100 x 120 INDUSTRIAL PALLET PERFORATED

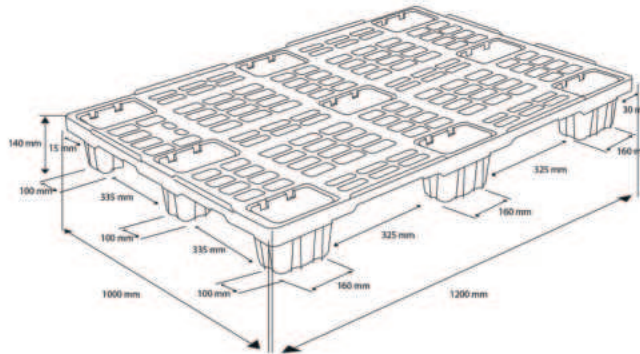

Başlıca Özellikler *Main Features*

İhracat Yöntemlerine Uygun / Suitable For Export Methods
 Otomatik Depo Yapısına Uygun / Suitable for Automatic Warehouse Structure
 Soğuk Hava Depolarına Uygun / Suitable for Cold Storage
 USDA, FDA, ISPM15 Yönetmeliklerine Uygun / Complies With USDA, FDA, ISPM 15 Regulations
 Kaymaz Taban Üst Yapı / Non-Slip Base Upper Structure
 Temiz ve Hijyenik / Clean and Hygienic
 İstiflenebilir / Stackable

Ölçüler / Dimensions L x W x H (cm)	Model	Tır yükleme adedi / Units on truck	40 HC
120 x 100 x 14	POWA-100120	2450	1800



KPTK 60 x 80 PALET

KPT 60 X 80 PALLET

Renkler
Colors

RAL 7000

RAL 3000

RAL 1018

RAL 6020

RAL 5022

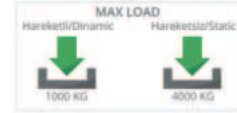

** İsteğe bağlı olarak taşıma kapasitesi artırılabilir.
The loading capacity can be increased optionally.

KPTK 100 x 120 PALET

KPTK 100 x 120 PALLET

Renkler
Colors

RAL 7000

RAL 3000

RAL 1018

RAL 6020

RAL 5022



** İsteğe bağlı olarak taşıma kapasitesi artırılabilir.
The loading capacity can be increased optionally.

* Özel renk üretim yapılabilir.
** Minimum sipariş detaylarını lütfen sorunuz.

* Special color production is possible.
** Please ask for minimum order details.

KPTK 60 x 80 PALET

KPT 60 X 80 PALLET

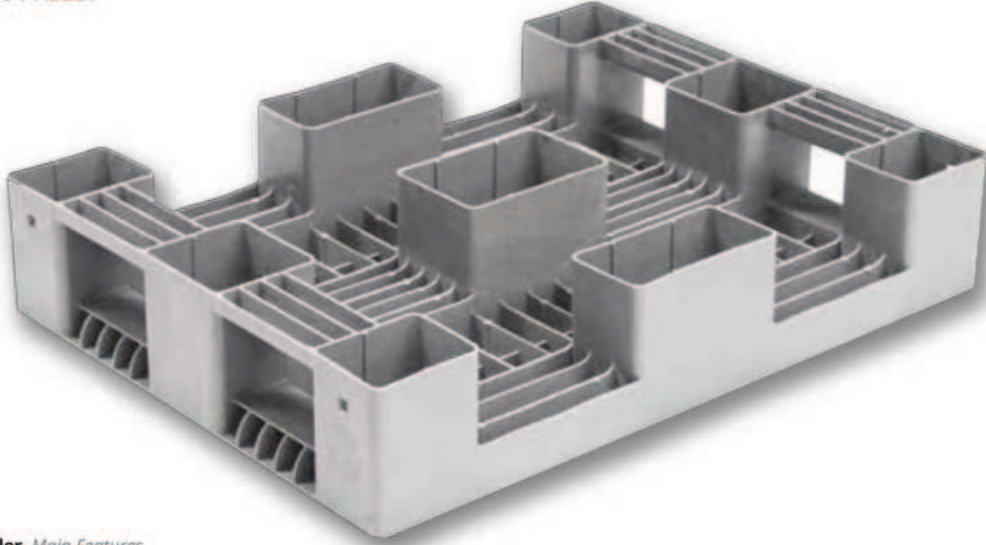
**Başlıca Özellikler** *Main Features*

Ürünlerimiz elektrikleme karşıtı antistatik toz itici kimyasallar içermektedir.

Asit, yağ ve gazlardan etkilenmez. Üretim hatalarından kaynaklanan ürünler 3 yıl garantilidir.

Our products contain antistatic, antistatic dust repellent chemicals. It is not affected by acid, oil and gases. Products caused by manufacturing faults are guaranteed for 3 years.

Ölçüler Dimensions L x W x H (cm)	Model	Tır yükleme adedi Units on truck	40 HC
80 x 60 x 15	KPTK-6080	1056	720

**KPTK 100 x 120 PALET**

KPTK 100 x 120 PALLET

**Başlıca Özellikler** *Main Features*

Ürünlerimiz elektrikleme karşıtı antistatik toz itici kimyasallar içermektedir.

Asit, yağ ve gazlardan etkilenmez. Üretim hatalarından kaynaklanan ürünler 3 yıl garantilidir.

Our products contain antistatic, antistatic dust repellent chemicals. It is not affected by acid, oil and gases. Products caused by manufacturing faults are guaranteed for 3 years.

Ölçüler Dimensions L x W x H (cm)	Model	Tır yükleme adedi Units on truck	40 HC
110 x 110 x 15	KPTK-110110	459	408
120 x 100 x 15	KPTK-100120	459	408



110 x 130 PALET KAPALI

110 x 130 PALLET SOLID

Renkler
Colors



İsteğe bağlı olarak taşıma kapasitesi artırılabilir.
The loading capacity can be increased optionally.

110 x 130 PALET DELİKLİ

110 x 130 PALLET PERFORATED

Renkler
Colors

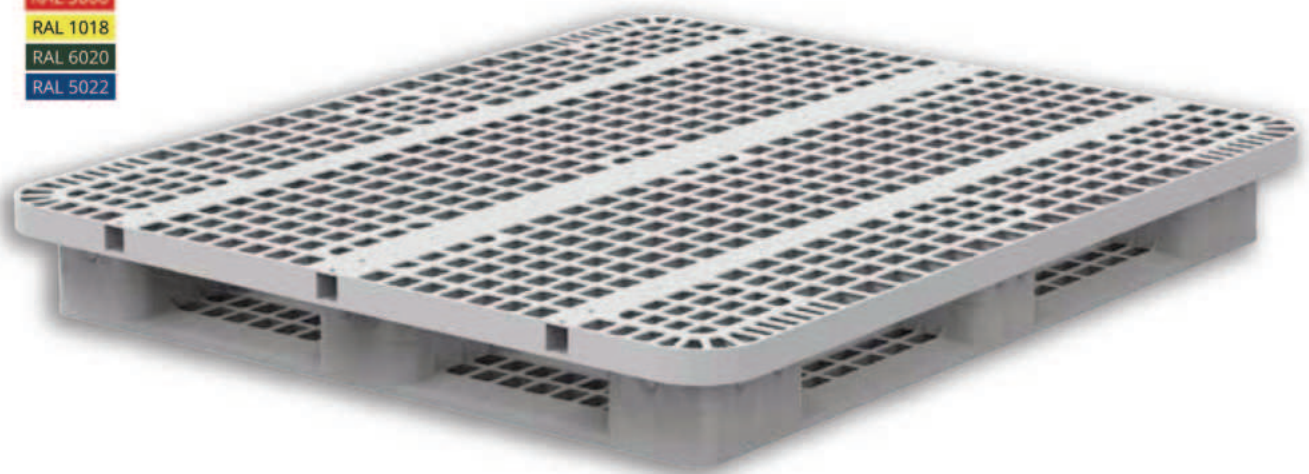

İsteğe bağlı olarak taşıma kapasitesi artırılabilir.
The loading capacity can be increased optionally.

* Özel renk üretim yapılabilir.
** Minimum sipariş detaylarını lütfen sorunuz.

* Special color production is possible.
** Please ask for minimum order details.

110 x 130 PALET KAPALI

110 x 130 PALLET SOLID

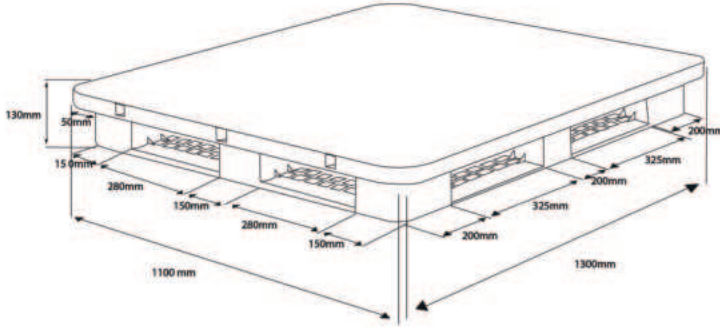
**Başlıca Özellikler** *Main Features*

Ürünlerimiz elektrikleme karşıtı antistatik toz itici kimyasallar içermezdir.

Asit, yağ ve gazlardan etkilenmez. Üretim hatalarından kaynaklanan ürünler 3 yıl garantilidir.

Our products contain antistatic, antistatic dust repellent chemicals. It is not affected by acid, oil and gases. Products caused by manufacturing faults are guaranteed for 3 years.

Ölçüler Dimensions L x W x H (cm)	Model	Tır yükleme adedi Units on truck	40 HC
130 x 110 x 15	KPTK-110130	414	342



110 x 130 PALET DELİKLİ

110 x 130 PALLET PERFORATED

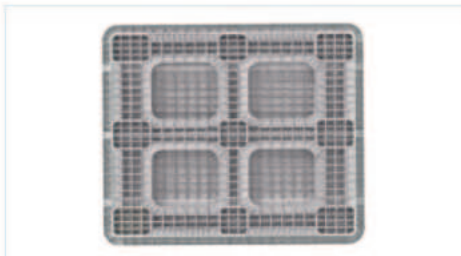
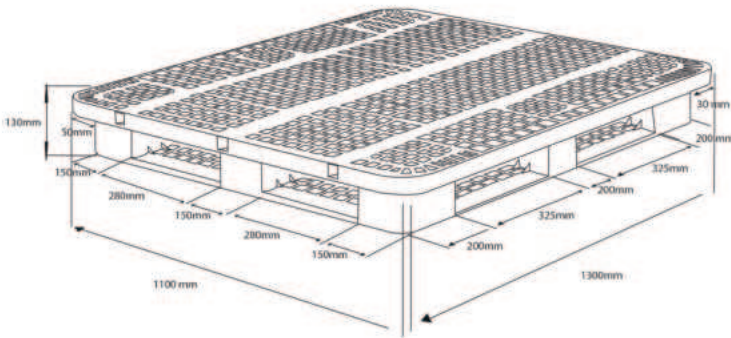

- Otomatik depo dijital sensör sistemine uygun
Suitable for automatic warehouse digital sensor system
- Palet kenar sıralama ve streç tutucu özelliği
Pallet edge sorting and stretch holder feature
- Forkliftte kaymayı önleyici tıplar ve tıpa ayak seçeneği
Anti-slip plugs and plug feet option on the forklift
- Kaymayı engelleyici alt kızak yüzeyi ve profil seçeneği
Anti-slip bottom skid surface and profile option and sectors.

Ölçüler Dimensions L x W x H (cm)	Model	Tır yükleme adedi Units on truck	40 HC
130 x 110 x 15	KPTA-110130	414	342



products: / ürünlər

03

Unlu Mamül Sebze Meyve Kasaları

Baked Product & Greengrocery Crates



YENİ MODEL ÇOK AMAÇLI KASALAR

NEW MODEL PURPOSE CRATES

Renkler
Colors

RAL 7000

RAL 3000

RAL 1018

RAL 6020

RAL 5022



K-6033K

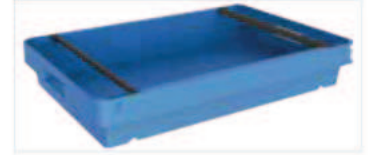

K-6033A

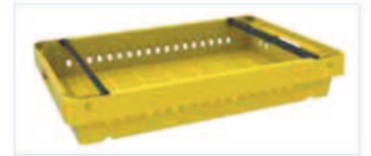

* Özel renk üretim yapılabilir.
** Minimum sipariş detaylarını lütfen sorunuz.

* Special color production is possible.
** Please ask for minimum order details.

Başlıca Özellikler

Main Features

Çok amaçlı kasalar, ağır koşullara dayanıklı ve sade olarak tasarlanmıştır. Yük homojen şekilde dağıldığından kaldırma kapasitesi yüksektir. Girinti çıkıntıları az olduğundan kolay temizlenir, hijyeniktir.

Multipurpose cases are designed to withstand harsh conditions. As the load is distributed homogeneously, the lifting capacity is high. It is easy to clean and hygienic as it has less indentations and protrusions.

- Hijyenik, HACCP sertifikalı modeller.
Hygienic, HACCP certified models.
- Nem, mantar ve böcek barındırmaz.
It does not contain moisture, fungi and insects.
- Doğaya ve çevreye saygılı, geri dönüşümlü.
Respectful to nature and the environment, recyclable.
- Her türlü yüke ve sektöre uygun geniş ürün çeşidi.
A wide range of products suitable for all kinds of loads and sectors.
- Yağ, asit vb. maddelerden etkilenmez.
It is not affected by oil, acid etc.
- Soğuk hava depolama ve hava sirkülasyonuna uygundur.
Suitable for cold storage and air circulation.

Ölçüler / Dimensions L x W x H (cm)	Model	Hacim / Volume (lt)	Tır yükleme adedi / Units on truck	40 HC
60 x 40 x 33	K-6033K / K-6033A	78	3432	2600
60 x 40 x 20	K-6020K / K-6020A	35	4778	2600
60 x 40 x 10	K-6010K / K-6010A	17,5	5332	2600

UNLU MAMÜL KASALARI

BAKED PRODUCT CRATES

Renkler

Colors

RAL 7000

RAL 3000

RAL 1018

RAL 6020

RAL 5022

KSA-6044 EKMEK KASASI
Bread CrateKD-74 EKMEK KASASI
Bread CrateK-66 EKMEK KASASI
Bread CrateK-71 TOST KASASI
Toast CrateK-68 HAMBURGER KASASI
Hamburger Crate

- Üstüste istiflenebilir.
It can be stacked on top of each other.
- Opsiyonel kapak.
Optional cover.

* Özel renk üretim yapılabilir.
** Minimum sipariş detaylarını lütfen sorunuz.

* Special color production is possible.
** Please ask for minimum order details.

Başlıca Özellikler

Main Features

Enjeksiyon yöntemiyle HDPE hammaddede ile üretilmektedir. Kolay temizlenir. Sıcağa, soğuğa, kimyasallara ve UV ışınlarına dayanıklıdır.
It is produced by injection method with HDPE raw material. Easy to clean. It is resistant to heat, cold, chemicals and UV rays.

Her türlü sektöre uygun geniş ürün çeşidi darbelerle karşı dayanıklıdır.
Wide product range suitable for every sector is resistant to impacts.

30 +70 derece ısı aralığının dışında kullanılmamalıdır.
It should not be used outside the temperature range of 30 + 70 degrees.

İçiçe geçebilme özelliği ile alandan tasarruf sağlar.
It saves space with its nesting feature.

- Hijyenik, HACCP sertifikalı modeller.
Hygienic, HACCP certified models.
- Nem, mantar ve böcek barındırmaz.
It does not contain moisture, fungi and insects.
- Doğaya ve çevreye saygılı, geri dönüşümlü.
Respectful to nature and the environment, recyclable.
- Her türlü yüke ve sektöre uygun geniş ürün çeşidi.
A wide range of products suitable for all kinds of loads and sectors.
- Yağ, asit vb. maddelerden etkilenmez.
It is not affected by oil, acid etc.
- Soğuk hava depolama ve hava sirkülasyonuna uygundur.
Suitable for cold storage and air circulation.
- Metale göre daha hafif ve ergonomiktir.
It is lighter and more ergonomic than metal.

Ölçüler / Dimensions L x W x H (cm)	Model	Hacim / Volume (lt)	Tır yükleme adedi / Units on truck	40 HC
40 x 60 x 33	K-66	-	3344	2800
62 x 46 x 15	K-71	-	3500	2800
56 x 68 x 9	K-68	-	4000	2500
60 x 40 x 44,5	KSA-6044	-	2000	660
41x 56 x 36,5	K-70	-	1188	900
40 x 60 x 37	KD-74	-	3150	2660
40 x 60 x 42	K-80	-	660	500

KATLANIR KASALAR

FOLDING CASES

Renkler

Colors

RAL 7000

RAL 3000

RAL 1018

RAL 6020

RAL 5022

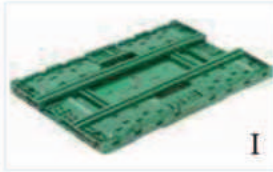
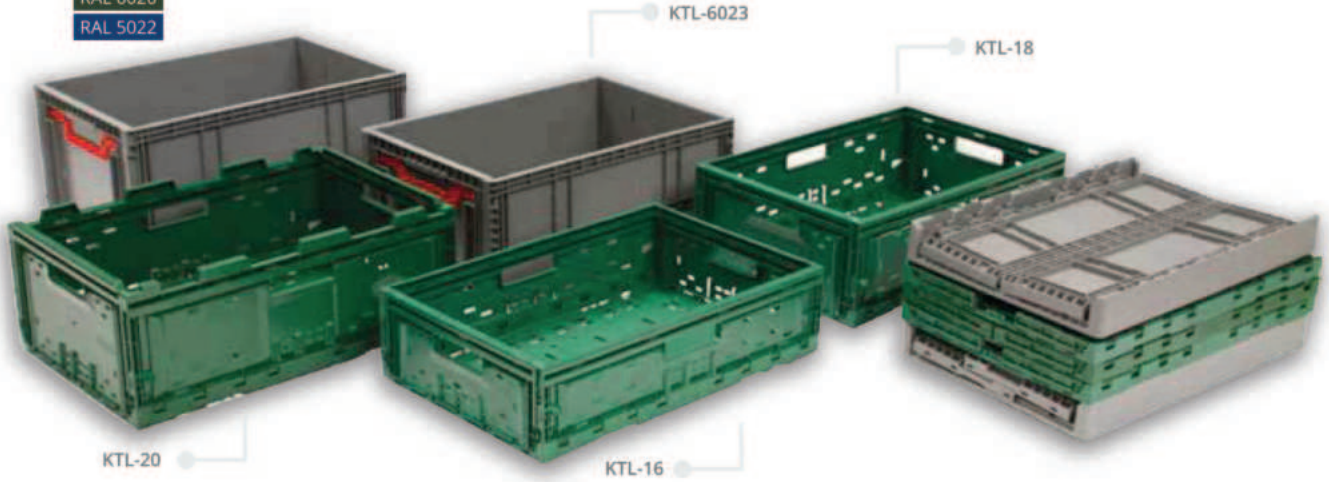

I

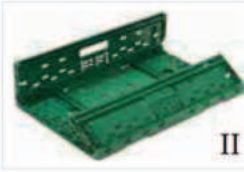

II



III



IV

* Özel renk üretim yapılabilir.

** Minimum sipariş detaylarını lütfen sorunuz.

* Special color production is possible.

** Please ask for minimum order details.

Başlıca Özellikler

Main Features

4 yönde tutma yerleri açıktır.

Hand grips in the 4 direction are open.

Üst üste istiflenebilir. Katlanmış yüksekliği 32 mm'dir.

It can be stacked on top of each other. Its folded height is 32mm.

Meyve, sebze, narenciye taşınmasında, marketler, manavlar ve pazarlarda sergilenmesinde kullanılmaktadır.

It is used for transporting fruits and vegetables, for display in markets and markets.

Enjeksiyon yöntemiyle HDPE hammadde ile üretilmektedir. Kolay temizlenir. Sıcağa, soğuğa, kimyasallara ve UV ışınlarına dayanıklıdır.

It is produced by injection method with HDPE raw material. Easy to clean. It is resistant to heat, cold, chemicals and UV rays.

Darbelere karşı dayanıklıdır.

Resistant to impacts.

- Hijyenik, HACCP sertifikalı modeller.
Hygienic, HACCP certified models.

- Nem, mantar ve böcek barındırmaz.

It does not contain moisture, fungi and insects.

- Doğaya ve çevreye saygılı, geri dönüşümlü.

Respectful to nature and the environment, recyclable.

Ölçüler / Dimensions L x W x H (cm)	Model	Hacim / Volume (lt)	Tır yüklemesi sayısı / Units on truck	40 HC
60 x 40 x 16	KTL-6016	-	-	-
60 x 40 x 18	KTL-6018	-	-	-
60 x 40 x 20	KTL-6020	-	-	-
60 x 40 x 23	KTL-6023	-	-	-



SEBZE MEYVE KASALARI

VEGETABLE & FRUIT CRATES

Renkler
Colors

RAL 7000

RAL 3000

RAL 1018

RAL 6020

RAL 5022



- Üstüste istiflenebilir.
It can be stacked on top of each other.
- Opsiyonel kapak.
Optional cover.

* Özel renk üretim yapılabilir.

** Minimum sipariş detaylarını lütfen sorunuz.

* Special color production is possible.

** Please ask for minimum order details.

Başlıca Özellikler

Main Features

Enjeksiyon yöntemiyle HDPE hammadde ile üretilmektedir. Kolay temizlenir. Sıcağa, soğuğa, kimyasallara ve UV ışınlarına dayanıklıdır.

It is produced by injection method with HDPE raw material. Easy to clean. It is resistant to heat, cold, chemicals and UV rays.

It saves space with its nesting feature.

Her türlü sektöre uygun geniş ürün çeşidi darbelerle karşı dayanıklıdır.

Wide product range suitable for every sector is resistant to impacts.

30 +70 derece ısı aralığının dışında kullanılmamalıdır.

It should not be used outside the temperature range of 30 +70 degrees.

İççe geçebilme özelliği ile alandan tasarruf sağlar.

It saves space with its nesting feature.

- Hijyenik, HACCP sertifikalı modeller.
Hygienic, HACCP certified models.
- Nem, mantar ve böcek barındırmaz.
It does not contain moisture, fungi and insects.
- Doğaya ve çevreye saygılı, geri dönüşümlü.
Respectful to nature and the environment, recyclable.
- Her türlü yüke ve sektöre uygun geniş ürün çeşidi.
A wide range of products suitable for all kinds of loads and sectors.
- Soğuk hava depolama ve hava sirkülasyonuna uygundur.
Suitable for cold storage and air circulation.

Ölçüler / Dimensions L x W x H (cm)	Model	Hacim / Volume (lt)	Tır yükleme adedi / Units on truck	40 HC
52 x 36,5 x 18	K-34	-	1540	1260
52 x 36,5 x 24	K-40	-	1540	1260
52 x 36,5 x 31	K-60	-	1848	1296



04

Yeni Tasarım



*Avadanlık Kasalar
New design Tool Crates*

Depolama, İstiflemeye Kolay
İzlenir Tasarım Kasalar
*Storage, Stacking,
Easy Traceable Crates*

products: / ürünler

Sanayi Kasaları

Industrial Crates



SANAYİ KASALARI (30cmx40cm)

INDUSTRIAL CRATES (30cmx40cm)

Renkler
Colors

RAL 7000

RAL 3000

RAL 1018

RAL 6020

RAL 5022



* Özel renk üretim yapılabilir.

** Minimum sipariş detaylarını lütfen sorunuz.

* Special color production is possible.

** Please ask for minimum order details.

Başlıca Özellikler

Main Features

Enjeksiyon yöntemiyle HDPE hammaddede ile üretilmektedir. Kolay temizlenir. Sıcığa, soğuğa, kimyasallara ve UV ışınlarına dayanıklıdır.

It is produced by injection method with HDPE raw material. Easy to clean. It is resistant to heat, cold, chemicals and UV rays.

It saves space with its nesting feature.

Her türlü sektöre uygun geniş ürün çeşidi darbelerle karşı dayanıklıdır.

Wide product range suitable for every sector is resistant to impacts.

30 +70 derece ısı aralığının dışında kullanılmamalıdır.

It should not be used outside the temperature range of 30 + 70 degrees.

• Hijyenik, HACCP sertifikalı modeller.

Hygienic, HACCP certified models.

• Nem, mantar ve böcek barındırmaz.

It does not contain moisture, fungi and insects.

• Doğaya ve çevreye saygılı, geri dönüşümlü.

Respectful to nature and the environment, recyclable.

• Her türlü yüke ve sektöre uygun geniş ürün çeşidi.

A wide range of products suitable for all kinds of loads and sectors.

• Yağ, asit vb. maddelerden etkilenmez.

It is not affected by oil, acid etc.

• Metale göre daha hafif ve ergonomiktir.

It is lighter and more ergonomic than metal.

Ölçüler / Dimensions L x W x H (cm)	Model	Hacim / Volume (lt)	Tır yüklemesi adedi / Units on truck	40 HC
40 x 30 x 12	KSK-3011	-	5280	4000
40 x 30 x 17,5	KSK-3017	-	3696	2800
40 x 30 x 23	KSK-3023	-	2640	2000
40 x 30 x 29	KSKD-3029	-	3250	2340
60 x 16 x 20	KSK-1620	-	4620	1800

SANAYİ KASALARI (40cmx60cm)

INDUSTRIAL CRATES (40cmx60cm)

Renkler
Colors

RAL 7000

RAL 3000

RAL 1018

RAL 6020

RAL 5022



* Özel renk üretim yapılabilir.
** Minimum sipariş detaylarını lütfen sorunuz.

* Special color production is possible.
** Please ask for minimum order details.

Başlıca Özellikler

Main Features

- 1 Üstüste istiflenebilir.
It can be stacked on top of each other.
- 2 Geçmeli sistem.
Telescopic system.
- 3 Özel çift duvar köşeler.
Special double wall corners.
- 4 Menteşe yuvaları.
Hinge Socket.
- 5 Logo ve yazı uygulanabilir.
Logo and text can be applied.

- Hijyenik, HACCP sertifikalı modeller.
Hygienic, HACCP certified models.
- Nem, mantar ve böcek barındırmaz.
It does not contain moisture, fungi and insects.
- Doğaya ve çevreye saygılı, geri dönüşümlü.
Respectful to nature and the environment, recyclable.
- Her türlü yüke ve sektöre uygun geniş ürün çeşidi.
A wide range of products suitable for all kinds of loads and sectors.
- Yağ, asit vb. maddelerden etkilenmez.
It is not affected by oil, acid etc.

Ölçüler / Dimensions L x W x H (cm)	Model	Hacim / Volume (lt)	Tır yükleme adedi / Units on truck	40 HC
60 x 40 x 6,5	KSD-6006	KSD-6006	5016	4180
60 x 40 x 10	KSD-6010	KSD-6010	3432	2860
60 x 40 x 12	KSD-6012	KSD-6012	2904	2420
60 x 40 x 15	KSD-6015	KSD-6015	2376	1980
60 x 40 x 17	KSK-6017	KSK-6017	1980	1650
60 x 40 x 20	KSD-6020	KSD-6020	1716	1430
60 x 40 x 23	KSK-6023	KSK-6023	1584	1320
60 x 40 x 28	KSD-6028	KSD-6028	1188	990
60 x 40 x 34	KSK-6034	KSK-6034	980	850
60 X 40 X 40	KSK-6040	KSK-6040	875	720
60 X 40 x 44	KSK-6044	KSK-6044	770	640
60 x 40 x 50	KSK-6050	KSK-6050	660	550

SANAYİ KASALARI YANDAN TUTAMAKLI (40cmx60cm)

INDUSTRIAL CRATES HANDLE ON SIDES (40cmx60cm)

Renkler
Colors

RAL 7000
RAL 3000
RAL 1018
RAL 6020
RAL 5022



* Özel renk üretim yapılabilir.
** Minimum sipariş detaylarını lütfen sorunuz.

* Special color production is possible.
** Please ask for minimum order details.

Başlıca Özellikler*Main Features*

- 1 **Üstüste istiflenebilir.**
It can be stacked on top of each other.
 - 2 **Geçmeli sistem.**
Telescopic system.
 - 3 **Özel çift duvar köşeler.**
Special double wall corners.
 - 4 **Menteşe yuvaları.**
Hinge Socket.
 - 5 **Logo ve yazı uygulanabilir.**
Logo and text can be applied.
 - 6 **Rahat yükleme ve boşaltma için tek tarafı açık kasalar.**
Robust plastic containers with intervention, far convenient loading and unloading in the stack.
 - 7 **Etiket uygulanabilir.**
Label is applicable.
- Hijyenik, HACCP sertifikalı modeller.
Hygienic, HACCP certified models.
 - Nem, mantar ve böcek barındırmaz.
It does not contain moisture, fungi and insects.
 - Doğaya ve çevreye saygılı, geri dönüşümlü.
Respectful to nature and the environment, recyclable.
 - Her türlü yüke ve sektöre uygun geniş ürün çeşidi.
A wide range of products suitable for all kinds of loads and sectors.
 - Yağ, asit vb. maddelerden etkilenmez.
It is not affected by oil, acid etc.

Ölçüler / Dimensions L x W x H (cm)	Model	Hacim / Volume (lt)	Tır yükleme adedi / Units on truck	40 HC
60 x 40 x 14,5	KSKYD-6014	-	2376	1980
60 x 40 x 17	KSKYD-6017	-	1980	1650
60 x 40 x 22	KSKYD-6022	-	1584	1320
60 x 40 x 28	KSKYD-6028	-	1188	990
60 x 40 x 32,5	KSKYD-6032	-	1056	880
60 x 40 x 42,5	KSKYD-6042	-	792	660
60 x 40 x 50	KSKYD-6050	-	660	550

DELİKLİ KASALAR

PERFERATED CRATES



Renkler
Colors

RAL 7000
RAL 3000
RAL 1018
RAL 6020
RAL 5022

K-20

KSA-6044

K-80

K-15

K-34

K-45

* Özel renk üretim yapılabilir.
** Minimum sipariş detaylarını lütfen sorunuz.

* Special color production is possible.
** Please ask for minimum order details.

Başlıca Özellikler

Main Features

Enjeksiyon yöntemiyle HDPE hammaddede ile üretilmektedir. Kolay temizlenir. Sıcığa, soğuğa, kimyasallara ve UV ışınlarına dayanıklıdır.
It is produced by injection method with HDPE raw material. Easy to clean. It is resistant to heat, cold, chemicals and UV rays.
It saves space with its nesting feature.
Her türlü sektöre uygun geniş ürün çeşidi darbelere karşı dayanıklıdır.
Wide product range suitable for every sector is resistant to impacts.
30 +70 derece ısı aralığının dışında kullanılmamalıdır.
It should not be used outside the temperature range of 30 + 70 degrees.

- Hijyenik, HACCP sertifikalı modeller.
Hygienic, HACCP certified models.
- Nem, mantar ve böcek barındırmaz.
It does not contain moisture, fungi and insects.
- Doğaya ve çevreye saygılı, geri dönüşümlü.
Respectful to nature and the environment, recyclable.
- Her türlü yüke ve sektöre uygun geniş ürün çeşidi.
A wide range of products suitable for all kinds of loads and sectors.
- Yağ, asit vb. maddelerden etkilenmez.
It is not affected by oil, acid etc.
- Soğuk hava depolama ve hava sirkülasyonuna uygundur.
Suitable for cold storage and air circulation.

Ölçüler / Dimensions W x L x H (cm)	Model	Hacim / Volume (lt)	Tır yükleme adedi / Units on truck	40 HC
58,5 x 38,5 x 15	K-15	-	2244	1100
58,5 x 38,5 x 21	K-20	-	1452	1100
50 x 34 x 17	K-24	-	1453	1100
50 x 34 x 21	K-34	-	4620	3250
52 x 36,5 x 24	K-40	-	1540	1260
40 x 40 x 17,5	K-45	-	2376	1800
62 x 42 x 13	K-50	-	1760	1368
52 x 36,5 x 31	K-60	-	1848	1296
58,5 x 38,5 x 33,5	K-75	-	1188	900
41 x 56 x 36	K-70	-	1188	900
58,5 x 38,5 x 42	K-80	-	660	500
48,5 x 68,5 x 45	K-90	-	616	480

KONİK LOGIBOX KASALAR

CONICAL LOGIBOX CRATES

Renkler
Colors

RAL 7000
RAL 3000
RAL 1018
RAL 6020
RAL 5022

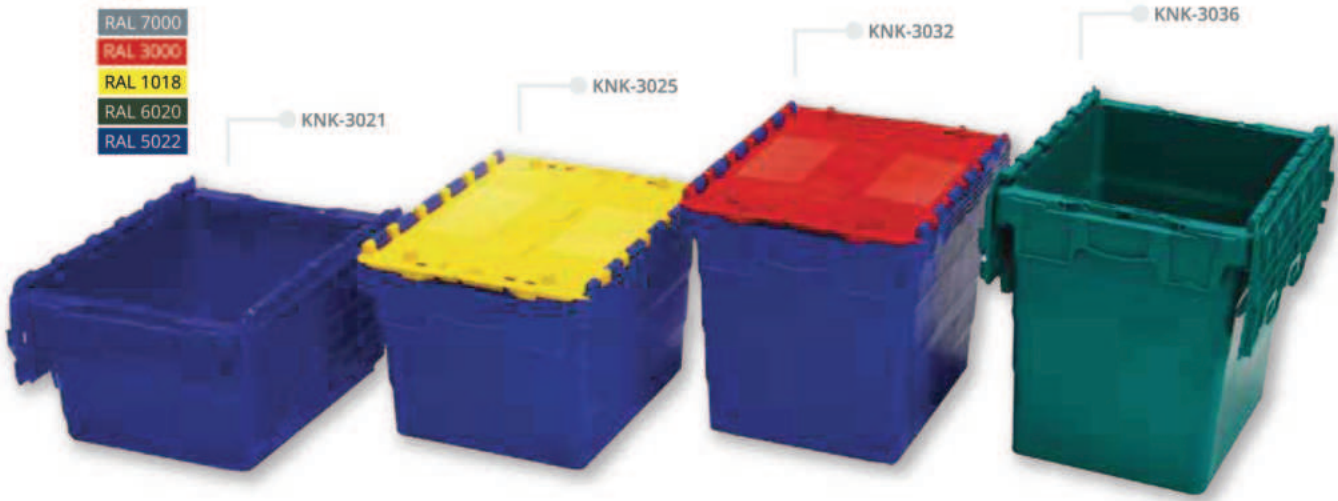

* Özel renk üretim yapılabilir.

** Minimum sipariş detaylarını lütfen sorunuz.

* Special color production is possible.

** Please ask for minimum order details.

Başlıca Özellikler

Main Features

- 1 İç içe geçebilme özelliği ile alandan tasarruf sağlar.
It saves space with its nesting feature.

- 2 KNK Logibox kasalar çok yönlü bir depolama yardımcısıdır. Dolu olduğunda kapakları kapatılarak üstüste istifleme imkanı sağlar.
KNK Logibox safes are a versatile storage aid. When full, the lids are closed and stacked on top of each other.

- 3 Üzerine etiketleme, barkod uygulanabilir.
Labeling and barcode can be applied on it.

- 4 Kapak kilitleme ve mühürleme sistemi.
Lid locking system.

- Hijyenik, HACCP sertifikalı modeller.
Hygienic, HACCP certified models.
- Nem, mantar ve böcek barındırmaz.
It does not contain moisture, fungi and insects.
- Doğaya ve çevreye saygılı, geri dönüşümlü.
Respectful to nature and the environment, recyclable.
- Her türlü yüke ve sektöre uygun geniş ürün çeşidi.
A wide range of products suitable for all kinds of loads and sectors.

Ölçüler / Dimensions W x L x H (cm)	Model	Hacim / Volume (lt)	Tır yükleme adedi / Units on truck	40 HC
40 x 30 x 20	KNKD-3021	16	-	6138
40 x 30 x 25	KNKD-3025	21	-	5940
40 x 30 x 32	KNKD-3032	27	-	5742
40 x 30 x 36,5	KNKD-3036	31	-	5544
60 x 40 x 25	KNKD-6025	40	-	2288
60 x 40 x 34	KNK-6034	60	-	2200
60 x 40 x 36,5	KNKD-6036	68	-	2112
60 x 40 x 41,6	KNKD-6041	77	-	2112



05

Çöp
Konteynerleri
Garbage Containers
3200 - 660 Lt.



products: / ürünler



1100 LT ATIK KONTEYNERİ

1100 LT GARBAGE BIN

Renkler
Colors

RAL 7000

RAL 3000

RAL 1018

RAL 6020

RAL 5022



** Minimum sipariş detaylarını lütfen sorunuz.
* Özel renk üretim yapılabilir.

* Special color production is possible.
** Please ask for minimum order details.

Başlıca Özellikler *Main Features*

Enjeksiyon yöntemiyle HDPE hammadde ile üretilmektedir. Kolay temizlenir. Sıcağa, soğuğa, kimyasallara ve UV ışınlarına dayanıklıdır.

Asit, yağ ve gazlardan etkilenmez. Üretim hatalarından kaynaklanan ürünler 3 yıl garantilidir.

Tekerlekler 200mm çapındadır ve ikisi kilitlenebilir.

It is produced by injection method with HDPE raw material. Easy to clean. It is resistant to heat, cold, chemicals and UV rays.

Our products contain antistatic, antistatic dust repellent chemicals.

It is not affected by acid, oil and gases. Products caused by manufacturing faults are guaranteed for 3 years.

200 mm Ø wheels, two with brakes.

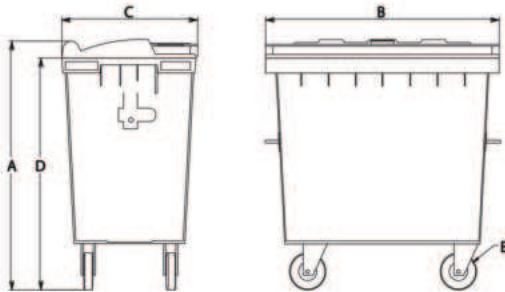

Hacim	Volume	L	1100	
Ağırlık	Weight	kg	50,50	
Azami Yük	Max. Load	kg	510	
A	Yükseklik	Height	mm	1305
B	Genişlik	Width	mm	1380
C	Derinlik	Depth	mm	1040
D	Tarak Yüksekliği	Comb Height	mm	1180
E	Tekerlek Çapı	Wheel Diameter	mm	200

Loading Capacity (piece)

Ölçüler (cm) / Dimensions (cm)	Model	Hacim (lt) / Volume (lt)	Tır / Truck			
			40 HC		40 HC	
			Tekerlekli With Fixed Wheel	Tekerleksiz Without Fixed Wheel	Tekerlekli With Fiex Wheel	Tekerleksiz Without Fixed Wheel
130,5 x 138 x 104	1100	1100	156	168	105	133



770 LT ATIK KONTEYNERİ

770 LT GARBAGE BIN

Renkler
Colors

RAL 7000

RAL 3000

RAL 1018

RAL 6020

RAL 5022



* Özel renk üretim yapılabilir.
** Minimum sipariş detaylarını lütfen sorunuz.

* Special color production is possible.
** Please ask for minimum order details.

Başlıca Özellikler *Main Features*

Enjeksiyon yöntemiyle HDPE hammadde ile üretilmektedir. Kolay temizlenir. Sıcağa, soğuğa, kimyasallara ve UV ışınlarına dayanıklıdır.

Asit, yağ ve gazlardan etkilenmez. Üretim hatalarından kaynaklanan ürünler 3 yıl garantilidir.

Tekerlekler 200mm çapındadır ve ikisi kilitlenebilir.

It is produced by injection method with HDPE raw material. Easy to clean. It is resistant to heat, cold, chemicals and UV rays.

Our products contain antistatic, antistatic dust repellent chemicals.

It is not affected by acid, oil and gases. Products caused by manufacturing faults are guaranteed for 3 years.

200 mm Ø wheels, two with brakes.

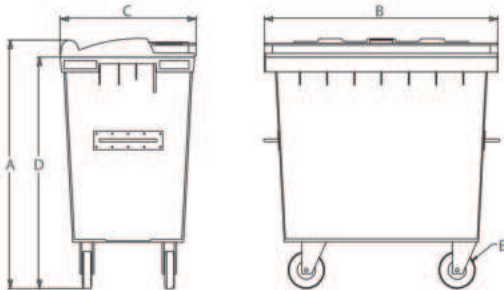

Hacim	Volume	L	770
Ağırlık	Weight	kg	48
Azami Yük	Max. Load	kg	370
A Yükseklik	Height	mm	1280
B Genişlik	Width	mm	1380
C Derinlik	Depth	mm	790
D Tarak Yüksekliği	Comb Height	mm	1190
E Tekerlek Çapı	Wheel Diameter	mm	200

Loading Capacity (piece)

Ölçüler (cm) / Dimensions (cm)	Model	Hacim (lt) / Volume (lt)	Loading Capacity (piece)			
			Tır / Truck		40 HC	
			Tekerlekli With Fixed Wheel	Tekerleksiz Without Fixed Wheel	Tekerlekli With Fiex Wheel	Tekerleksiz Without Fixed Wheel
128 x 138 x 79	770	1100	180	210	145	162

660 LT ATIK KONTEYNERİ

660 LT GARBAGE BIN

Renkler
Colors

RAL 7000
RAL 3000
RAL 1018
RAL 6020
RAL 5022



* Özel renk üretim yapılabilir.
** Minimum sipariş detaylarını lütfen sorunuz.

* Special color production is possible.
** Please ask for minimum order details.

Başlıca Özellikler *Main Features*

Enjeksiyon yöntemiyle HDPE hammadde ile üretilmektedir. Kolay temizlenir. Sıcağa, soğuğa, kimyasallara ve UV ışınlarına dayanıklıdır. Asit, yağ ve gazlardan etkilenmez. Üretim hatalarından kaynaklanan ürünler 3 yıl garantilidir.

Tekerlekler 200mm çapındadır ve ikisi kilitlenebilir.

It is produced by injection method with HDPE raw material. Easy to clean. It is resistant to heat, cold, chemicals and UV rays.

Our products contain antistatic, antistatic dust repellent chemicals.

It is not affected by acid, oil and gases. Products caused by manufacturing faults are guaranteed for 3 years.

200 mm Ø wheels, two with brakes.

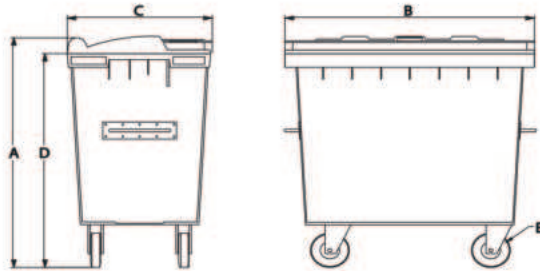

Hacim	Volume	L	660	
Ağırlık	Weight	kg	47	
Azami Yük	Max. Load	kg	310	
A	Yükseklik	Height	mm	1170
B	Genişlik	Width	mm	1380
C	Derinlik	Depth	mm	790
D	Tarak Yüksekliği	Comb Height	mm	1060
E	Tekerlek Çapı	Wheel Diameter	mm	200

Loading Capacity (piece)

Ölçüler (cm) / Dimensions (cm)	Model	Hacim (lt) / Volume (lt)	Tır / Truck			
			40 HC		40 HC	
			Tekerlekli With Fixed Wheel	Tekerleksiz Without Fixed Wheel	Tekerlekli With Flex Wheel	Tekerleksiz Without Fixed Wheel
117 x 138 x 79	660	660	180	210	145	162



660 - 770 - 1100 LT ATIK KONTEYNERLERİ OPSİYONEL ÖZELLİKLERİ

660 - 770 - 1100 LT GARBAGE BINS OPTIONAL FEATURES



- 1 Çöp atmanızı kolaylaştıracak önden açılır kapak.
Front-opening lid to facilitate your garbage disposal.
- 2 Üstten yarım açılır kapak.
Top half open lid.
- 3 Gövde ve kapak farklı renk opsiyonu.
Body and cover different color options.
- 4 Darbelere karşı koruma.
Impact protection.
- 5 Metal Pedallar.
Metal pedals.
- 6 Çekme aparatı.
Tow handle.

- 7 Kapak içi kapak.
Lid in lid.
- 8 Tahliye deliği veya monoblok kapalı alternatif.
Evacuation hole or monoblock closed alternative.
- 9 Metal çift taraflı kollar.
Metal both side handlers.
- 10 Mıyolu.
Trunnion.
- 11 Forklift ile kaldırma opsiyonu.
Lifting option with forklift.
- 12 Etiket uygulanabilir.
Sticker can be applied.

1100 - 770 - 660 LT KAPAKLI ÇELİK ATIK KONTEYNERİ

1100 - 700 - 660 LT STEEL GARBAGE CONTAINER WITH PLASTIC LID

Renkler
Colors

RAL 7000
RAL 3000
RAL 1018
RAL 6020
RAL 5022

**Başlıca Özellikler** *Main Features*

Galvaniz kalınlığı 1,5 mm
Kapak kalınlığı 4 mm
Kapak HDPE malzeme olup opsiyonel kapak renkleri mevcuttur.
Taban levhası kalınlığı 2mm

*Galvanized thickness 1.5 mm
Cover thickness 4 mm
The cover is HDPE material and optional cover colors are available.
Base plate thickness 2mm*

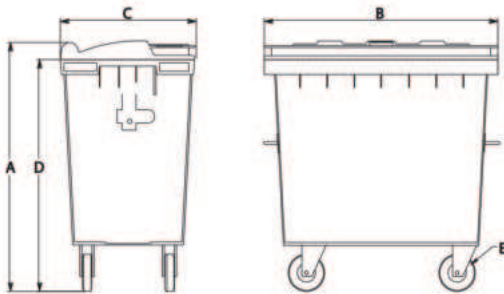

Hacim	Volume	L	1100 - 770 - 660
Ağırlık	Weight	kg	50,60 - 75 - 65
Azami Yük	Max. Load	kg	510 - 500 - 500
A Yükseklik	Height	mm	1290 - 1150 - 1000
B Genişlik	Width	mm	1270 - 1200 - 1200
C Derinlik	Depth	mm	1060 - 730 - 730
E Tekerlek Çapı	Wheel Diameter	mm	200 - 150 - 150

Loading Capacity (piece)

Ölçüler (cm) / Dimensions (cm)	Model	Hacim (lt) / Volume (lt)	Loading Capacity (piece)			
			Tır / Truck		40 HC	
			Tekerlekli With Fixed Wheel	Tekerleksiz Without Fixed Wheel	Tekerlekli With Flex Wheel	Tekerleksiz Without Fixed Wheel
129 x 127 x 106	1100	1100	130	-	156	-
115 x 120 x 73	770	770	150	-	180	-
100 x 120 x 73	660	660	140	-	168	-

3200 LT ÇÖP KONTEYNERİ

3200 LT GARBAGE CONTAINER

Renkler
Colors

RAL 7000
RAL 3000
RAL 1018
RAL 6020
RAL 5022



* Bu ürünün tedarikçi firmasıyız.
** Minimum sipariş detaylarını lütfen sorunuz.

* We are the Supplier of This Product.
** Please ask for minimum order details.

Başlıca Özellikler *Main Features*

Yandan yüklemeli 3.200 L'lık konteyner, çevre dostu, geri dönüştürülebilir malzemelerle birlikte son teknoloji makineler ve kalıplar kullanılarak enjeksiyonla kalıplanmış polietilenden üretilmiştir. Enjeksiyon kalıplama, sabit renkler, tam korozyon direnci, pürüzsüz yüzeyler ve aşınma veya çatlama olmadan günlük darbelerle dayanma yeteneği dahil olmak üzere plastiğin avantajlarından yararlanmayı mümkün kılar.

The side-loading 3,200 L container is manufactured from injection-moulded polyethylene, using state-of-the-art machinery and moulds, together with environmentally-friendly, recyclable materials. Injection moulding makes it possible to take advantage of the benefits of plastic, including stable colours, full corrosion resistance, smooth surfaces and the ability to withstand everyday impacts without denting or cracking.

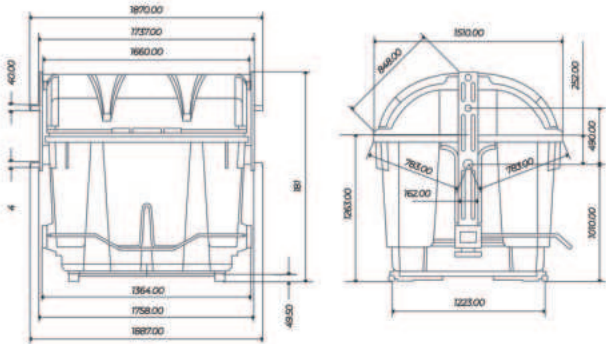

Hacim	Volume	L	3200
Ağırlık	Weight	kg	146
Azami Yük	Max. Load	kg	1280
Yükseklik	Height	mm	1810
Genişlik	Width	mm	1510
Derinlik	Depth	mm	1870

Loading Capacity (piece)

Ölçüler (cm) / Dimensions (cm)	Model	Hacim (lt) / Volume (lt)	Loading Capacity (piece)			
			Tır / Truck		40 HC	
			Tekerlekli With Fixed Wheel	Tekerleksiz Without Fixed Wheel	Tekerlekli With Flex Wheel	Tekerleksiz Without Fixed Wheel
181 x 151 x 187	3200	3200	-	-	-	-

products: / ürünler

06

ÇÖP
KONTEYNERLERİ
Garbage Containers
360 - 7 Lt.



360 LT ATIK KONTEYNERİ

360 LT GARBAGE CONTAINER

Renkler
Colors

RAL 7000
RAL 3000
RAL 1018
RAL 6020
RAL 5022



* Özel renk üretim yapılabilir.

** Minimum sipariş detaylarını lütfen sorunuz.

* Special color production is possible.

** Please ask for minimum order details.

Başlıca Özellikler *Main Features*

Enjeksiyon yöntemiyle HDPE hammadde ile üretilmektedir. Kolay temizlenir. Sıcağa, soğuğa, kimyasallara ve UV ışınlarına dayanıklıdır. Asit, yağ ve gazlardan etkilenmez. Üretim hatalarından kaynaklanan ürünler 3 yıl garantilidir. Tekerlekler 200mm çapındadır.

It is produced by injection method with HDPE raw material. Easy to clean. It is resistant to heat, cold, chemicals and UV rays.

Our products contain antistatic, antistatic dust repellent chemicals.

It is not affected by acid, oil and gases. Products caused by manufacturing faults are guaranteed for 3 years.

200 mm Ø wheels.

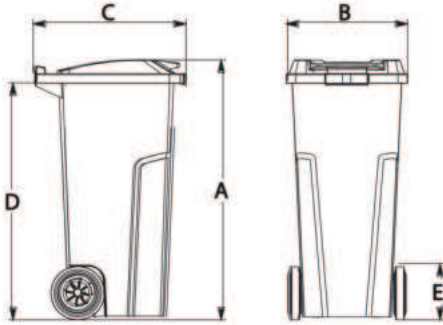

Hacim	Volume	L	360	
Ağırlık	Weight	kg	25	
Azami Yük	Max. Load	kg	160	
A	Yükseklik	Height	mm	110
B	Genişlik	Width	mm	620
C	Derinlik	Depth	mm	860
D	Tarak Yüksekliği	Comb Height	mm	1000
E	Tekerlek Çapı	Wheel Diameter	mm	200

Ölçüler (cm) / Dimensions (cm)	Model	Hacim (lt) / Volume (lt)	Bulk Loading Capacity (piece)		Pallet Loading Capacity (piece)	
			Tır / Truck	40 HC	Tır / Truck	40 HC
110 x 62 x 86	360	360	812	650	560	480



240 LT ATIK KONTEYNERİ

240 LT GARBAGE CONTAINER

Renkler
Colors

RAL 7000
RAL 3000
RAL 1018
RAL 6020
RAL 5022



* Özel renk üretim yapılabilir.
** Minimum sipariş detaylarını lütfen sorunuz.

* Special color production is possible.
** Please ask for minimum order details.

Başlıca Özellikler Main Features

Enjeksiyon yöntemiyle HDPE hammadde ile üretilmektedir. Kolay temizlenir. Sıcağa, soğuğa, kimyasallara ve UV ışınlarına dayanıklıdır. Asit, yağ ve gazlardan etkilenmez. Üretim hatalarından kaynaklanan ürünler 3 yıl garantilidir. Tekerlekler 200mm çapındadır.

It is produced by injection method with HDPE raw material. Easy to clean. It is resistant to heat, cold, chemicals and UV rays.

Our products contain antistatic, antistatic dust repellent chemicals.

It is not affected by acid, oil and gases. Products caused by manufacturing faults are guaranteed for 3 years.

200 mm Ø wheels

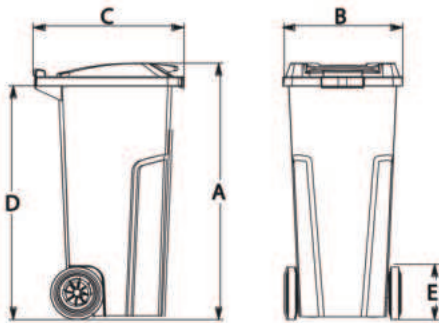

Hacim	Volume	L	240
Ağırlık	Weight	kg	13
Azami Yük	Max. Load	kg	96
A Yükseklik	Height	mm	1080
B Genişlik	Width	mm	560
C Derinlik	Depth	mm	720
D Tarak Yüksekliği	Comb Height	mm	990
E Tekerlek Çapı	Wheel Diameter	mm	200

Ölçüler (cm) / Dimensions (cm)	Model	Hacim (lt) / Volume (lt)	Bulk Loading Capacity (piece)		Pallet Loading Capacity (piece)	
			Tır / Truck	40 HC	Tır / Truck	40 HC
107 x 60 x 75	KP 240	240	812	650	560	480
108 x 56 x 72	240	240	812	650	560	480

240 LT ATIK KONTEYNERLERİ OPSİYONEL SİZE ÖZEL TASARIM ÜRETEBİLİRİZ.

WE CAN PRODUCE 240 LT GARBAGE CONTAINERS IN YOUR SPECIAL DESIGN.

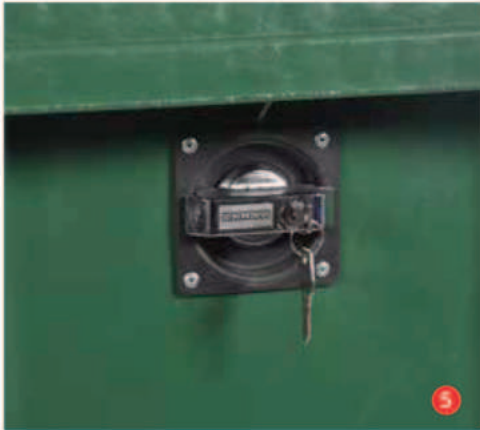

1 Çift renk logo uygulanabilir.
Two color logo can be applied.

2 Kauçuk kapak opsiyonu.
Rubber lid option.

3 Hastaneler için özel çift katlı sessiz patentli özel hijyenik hammadde ile üretilen tekerlekler.
Silent, patented, hygienic wheels.

4 Metal pedallar.
Metal pedals.

5 Kapak kilit sistemi yapılabilir.
Lid locking system can be apply.

6 Etiket ve sıcak baskı uygulanabilir.
Sticker and hot stamping can be applied.

KP-120 LT ATIK KONTEYNERİ

KP-120 LT GARBAGE CONTAINER

Renkler
Colors

RAL 7000
RAL 3000
RAL 1018
RAL 6020
RAL 5022



* Özel renk üretim yapılabilir.
** Minimum sipariş detaylarını lütfen sorunuz.

* Special color production is possible.
** Please ask for minimum order details.

Başlıca Özellikler *Main Features*

Enjeksiyon yöntemiyle HDPE hammadde ile üretilmektedir. Kolay temizlenir. Sıcağa, soğuğa, kimyasallara ve UV ışınlarına dayanıklıdır. Asit, yağ ve gazlardan etkilenmez. Üretim hatalarından kaynaklanan ürünler 3 yıl garantilidir.

Tekerlekler 200mm çapındadır

It is produced by injection method with HDPE raw material. Easy to clean. It is resistant to heat, cold, chemicals and UV rays.

Our products contain antistatic, antistatic dust repellent chemicals.

It is not affected by acid, oil and gases. Products caused by manufacturing faults are guaranteed for 3 years.

200 mm Ø wheels

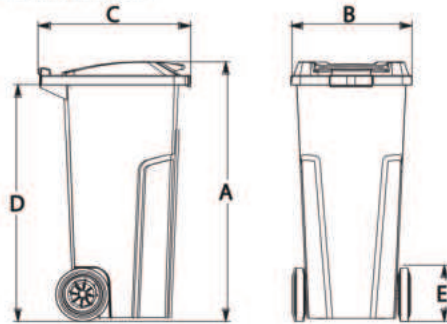

Hacim	Volume	L	120 - KP 120
Pedalsız Ağırlık	Weight Without Pedal	kg	8,6 - 8,6
Azami Yük	Max. Load	kg	48 - 48
A	Yükseklik	Height	mm 980 - 940
B	Genişlik	Width	mm 460 - 470
C	Derinlik	Depth	mm 570 - 540
D	Tarak Yüksekliği	Comb Height	mm 910 - 910
E	Tekerlek Çapı	Wheel Diameter	mm 200 - 200

Ölçüler (cm) / Dimensions (cm)	Model	Hacim (lt) / Volume (lt)	Bulk Loading Capacity (piece)		Pallet Loading Capacity (piece)	
			Tır / Truck	40 HC	Tır / Truck	40 HC
94 x 47 x 54	KP 120	120	1400	1182	1260	1000



120 LT KİLİT KAPAKLI ATIK KONTEYNERİ

120 LT GARBAGE CONTAINER WITH LOCK

Renkler
Colors

RAL 7000
RAL 3000
RAL 1018
RAL 6020
RAL 5022

**Başlıca Özellikler** *Main Features*

Enjeksiyon yöntemiyle HDPE hammadde ile üretilmektedir. Kolay temizlenir. Sıcağa, soğuğa, kimyasallara ve UV ışınlarına dayanıklıdır. Asit, yağ ve gazlardan etkilenmez. Üretim hatalarından kaynaklanan ürünler 3 yıl garantilidir.

Tekerlekler 200mm çapındadır

It is produced by injection method with HDPE raw material. Easy to clean. It is resistant to heat, cold, chemicals and UV rays.

Our products contain antistatic, antistatic dust repellent chemicals.

It is not affected by acid, oil and gases. Products caused by manufacturing faults are guaranteed for 3 years.

200 mm Ø wheels

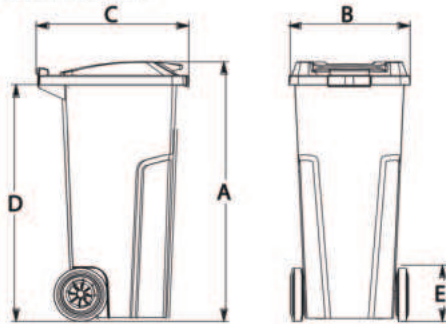

Hacim	Volume	L	120 - KP 120
Pedalsız Ağırlık	Weight Without Pedal	kg	8,6 - 8,6
Azami Yük	Max. Load	kg	48 - 48
A Yükseklik	Height	mm	980 - 940
B Genişlik	Width	mm	460 - 470
C Derinlik	Depth	mm	570 - 540
D Tarak Yüksekliği	Comb Height	mm	910 - 910
E Tekerlek Çapı	Wheel Diameter	mm	200 - 200

Bulk Loading Capacity (piece)

Pallet Loading Capacity (piece)

Ölçüler (cm) / Dimensions (cm)	Model	Hacim (lt) / Volume (lt)	Tır / Truck	40 HC	Tır / Truck	40 HC
98 x 46 x 57	120	120	1400	1182	1260	1000



80 - 60 - 40 LT SMART ECO FRIENDLY ÇÖP KOVASI

80 - 60 - 40 LT SMART ECO FRIENDLY GARBAGE CONTAINERS

Renkler
Colors

* Özel renk üretim yapılabilir.

** Minimum sipariş detaylarını lütfen sorunuz.

* Special color production is possible.

** Please ask for minimum order details.

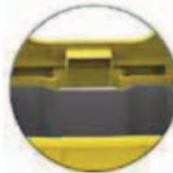
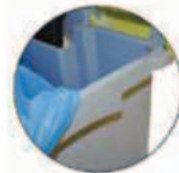
Pedalsız Sistem
Without PedalPedallı Sistem
With PedalKova içi kova
Bucket insidePoest Tutucu
Suitable for plastic bags**Başlıca Özellikler** *Main Features*

Enjeksiyon yöntemiyle HDPE hammadde ile üretilmektedir. Kolay temizlenir. Sıcağa, soğuğa, kimyasallara ve UV ışınlarına dayanıklıdır. Asit, yağ ve gazlardan etkilenmez. Üretim hatalarından kaynaklanan ürünler 3 yıl garantilidir.

It is produced by injection method with HDPE raw material. Easy to clean. It is resistant to heat, cold, chemicals and UV rays.

Our products contain antistatic, antistatic dust repellent chemicals.

It is not affected by acid, oil and gases. Products caused by manufacturing faults are guaranteed for 3 years.

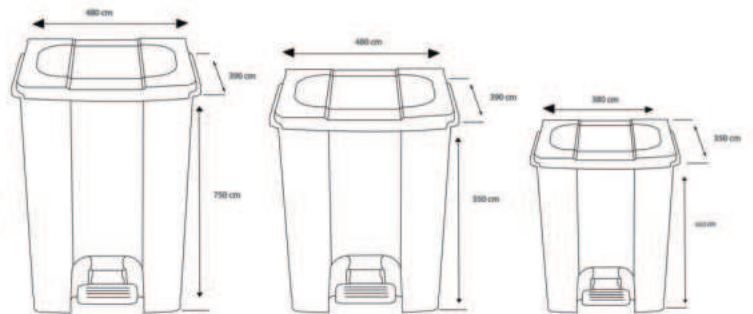

Ölçüler (cm) / Dimensions (cm)	Model	Hacim (lt) / Volume (lt)	Tır / Truck	40 HC
46 x 38 x 35	40	40	2160	2592
55 x 48 x 39	60	60	1464	1756
75 x 48 x 39	80	80	1280	1536

80 - 60 - 30 LT SMART ECO FRIENDLY ÇÖP KOVASI OPSİYONLAR

80 - 60 - 30 LT SMART ECO FRIENDLY GARBAGE CONTAINERS OPTIONS



85 LT ATIK KONTNERİ

85 LT GARBAGE CONTAINER

Renkler
Colors

RAL 7000

RAL 3000

RAL 1018

RAL 6020

RAL 5022



* Özel renk üretim yapılabilir.
** Minimum sipariş detaylarını lütfen sorunuz.

* Special color production is possible.
** Please ask for minimum order details.

Başlıca Özellikler *Main Features*

Enjeksiyon yöntemiyle HDPE hammadde ile üretilmektedir. Kolay temizlenir. Sıcağa, soğuğa, kimyasallara ve UV ışınlarına dayanıklıdır. Asit, yağ ve gazlardan etkilenmez. Üretim hatalarından kaynaklanan ürünler 3 yıl garantilidir.

Tekerlekler 200mm çapındadır ve ikisi kilitlenebilir.

It is produced by injection method with HDPE raw material. Easy to clean. It is resistant to heat, cold, chemicals and UV rays.

Our products contain antistatic, antistatic dust repellent chemicals.

It is not affected by acid, oil and gases. Products caused by manufacturing faults are guaranteed for 3 years.

200 mm \square wheels, two with brakes.

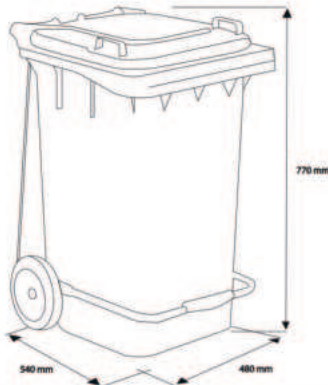

Hacim	Volume	L	85
Pedalsız Ağırlık	Weight Without Pedal	kg	-
Azami Yük	Max. Load	kg	-
A Yükseklik	Height	mm	770
B Genişlik	Width	mm	480
C Derinlik	Depth	mm	540
D Tarak Yüksekliği	Comb Height	mm	740
E Tekerlek Çapı	Wheel Diameter	mm	200

Ölçüler (cm) / Dimensions (cm)	Model	Hacim (lt) / Volume (lt)	Tır / Truck	40 HC
77 x 48 x 54	85	85	1600	1400



70 LT ATIK KONTNERİ

70 LT GARBAGE CONTAINER

Renkler
Colors

RAL 7000
RAL 3000
RAL 1018
RAL 6020
RAL 5022

**Başlıca Özellikler** *Main Features*

Enjeksiyon yöntemiyle HDPE hammadde ile üretilmektedir. Kolay temizlenir. Sıcağa, soğuğa, kimyasallara ve UV ışınlarına dayanıklıdır. Asit, yağ ve gazlardan etkilenmez. Üretim hatalarından kaynaklanan ürünler 3 yıl garantilidir.

Tekerlekler 200mm çapındadır ve ikisi kilitlenebilir.

It is produced by injection method with HDPE raw material. Easy to clean. It is resistant to heat, cold, chemicals and UV rays.

Our products contain antistatic, antistatic dust repellent chemicals.

It is not affected by acid, oil and gases. Products caused by manufacturing faults are guaranteed for 3 years.

200 mm \square wheels, two with brakes.



Hacim	Volume	L	70
Azami Yük	Max. Load	kg	27
A	Yükseklik	Height	mm 720
B	Genişlik	Width	mm 400
C	Derinlik	Depth	mm 360
D	Tarak Yüksekliği	Comb Height	mm 690

Ölçüler (cm) / Dimensions (cm)	Model	Hacim (lt) / Volume (lt)	Tır / Truck	40 HC
72 x 40 x 36	70	70	3400	2754

EV OFİS TİPİ ÇÖP KOVALARI

HOME & OFFICE TYPE GARBAGE CONTAINERS

Renkler
Colors

50 Lt.



30 Lt.



12 Lt.



No 3 Sepet 7 Lt.



* Özel renk üretim yapılabilir.
** Minimum sipariş detaylarını lütfen sorunuz.

* Special color production is possible.
** Please ask for minimum order details.

Başlıca Özellikler *Main Features*

Enjeksiyon yöntemiyle HDPE hammadde ile üretilmektedir. Kolay temizlenir. Sıcağa, soğuğa, kimyasallara ve UV ışınlarına dayanıklıdır. Asit, yağ ve gazlardan etkilenmez. Üretim hatalarından kaynaklanan ürünler 3 yıl garantilidir.

It is produced by injection method with HDPE raw material. Easy to clean. It is resistant to heat, cold, chemicals and UV rays. Our products contain antistatic, antistatic dust repellent chemicals.

It is not affected by acid, oil and gases. Products caused by manufacturing faults are guaranteed for 3 years.

Ölçüler (cm) / Dimensions (cm)	Model	Hacim (lt) / Volume (lt)
Ø 26,5 x 31,5	No 3 SEPET	7
Ø 26,5 x 31,5	257	12
Ø 26,5 x 31,5	172	30
Ø 26,5 x 31,5	105	50



YUVARLAK ÇÖP KOVALARI

ROUNDED GARBAGE CONTAINERS

Renkler
Colors

RAL 7000
RAL 3000
RAL 1018
RAL 6020
RAL 5022



Ekmek gıda toplama 90 Lt.
Food collection box 90 Lt.

İtme kapaklı.
Swing lid.

Yere Sabitlenebilir.
Can be fixed ground.



Yuvarlak 90 Lt.



4003 MEGA



4007-4004 50-60 Lt.

Başlıca Özellikler *Main Features*

Enjeksiyon yöntemiyle HDPE hammadde ile üretilmektedir. Kolay temizlenir. Sıcağa, soğuğa, kimyasallara ve UV ışınlarına dayanıklıdır. Asit, yağ ve gazlardan etkilenmez. Üretim hatalarından kaynaklanan ürünler 3 yıl garantilidir.

It is produced by injection method with HDPE raw material. Easy to clean. It is resistant to heat, cold, chemicals and UV rays.

Our products contain antistatic, antistatic dust repellent chemicals.

It is not affected by acid, oil and gases. Products caused by manufacturing faults are guaranteed for 3 years.

Ölçüler (cm) / Dimensions (cm)	Model	Hacim (lt) / Volume (lt)
Ø 51,5 x 45	4007	50
Ø 57 x 48	4004	60
Ø 55,5 x 49	4003 MEGA	71
Ø 45 x 88	GIDA TOPLAMA / FOOD COLLECTION 90 Lt.	90
Ø 45 x 66	YUVARLAK / ROUND 90 Lt.	90

products: / ürünlər

07

Bulaşık Sepetleri

Dishwasher Racks

Yıkama, taşıma ve istifleme için bulaşık basketlerinde size özel modeller.

Special models for washing, transporting and stacking dishes.



ÇATAL KAŞIK BASKETİ

CUTTLERY RACK

Renkler
Colors

- RAL 7000
- RAL 3000
- RAL 1018
- RAL 6020
- RAL 5022



Kod / Code	Ürün / Product	Ölçüler (cm) / Dimensions (cm)	Koli adedi / Pcs in box	Tır / Truck	40 HC
152087518	Çatal Kaşık Basketi / Cutlery Rack	50,1x50,1x10,1	6	3000	2574



TEPSİ BASKETİ

TRAY RACK

Renkler
Colors

- RAL 7000
- RAL 3000
- RAL 1018
- RAL 6020
- RAL 5022



Kod / Code	Ürün / Product	Ölçüler (cm) / Dimensions (cm)	Koli adedi / Pcs in box	Tır / Truck	40 HC
152088038	Tepsi Basketi / Tray Rack	50,1x50,1x10,1	6	3000	2574



TEMEL BASKET

BASE RACK

Renkler
Colors

- RAL 7000
- RAL 3000
- RAL 1018
- RAL 6020
- RAL 5022



Kod / Code	Ürün / Product	Ölçüler (cm) / Dimensions (cm)	Koli adedi / Pcs in box	Tır / Truck	40 HC
152087508	Temel Basket / Base Rack	50,1x50,1x10,1	6	3000	2574

**TABAK BASKETİ**

PLATE RACK

Renkler
Colors

- RAL 7000
- RAL 3000
- RAL 1018
- RAL 6020
- RAL 5022



Kod / Code	Ürün / Product	Ölçüler (cm) / Dimensions (cm)	Koli adedi / Pcs in box	Tır / Truck	40 HC
152087528	Tabak Basketi / Plate Rack	50,1x50,1x10,1	6	3000	2574



35 x 35 BARDAK BASKETİ CUTTLERY RACK

Renkler
 Colors

RAL 7000

RAL 3000

RAL 1018

RAL 6020

RAL 5022



ÇATAL KAŞIK TUTUCU CUTTLERY RACK

Renkler
 Colors

RAL 7000

RAL 3000

RAL 1018

RAL 6020

RAL 5022



Kod / Code	Ürün / Product	Ölçüler (cm) / Dimensions (cm)	Koli adedi / Pcs in box	Tır / Truck	40 HC
152088058	35x35 Bardak Basketi / 35x35 Glass Rack	35x35x13,5			
152088048	Çatal-Kaşık Tutucu / Cutlery Holder	41x21x15	10	5000	4290
152088063	Çatal-Kaşık Toplama Kutusu / Cutlery Collecting Box	50,1x50,1x10,1			



BÖLÜMLEYİCİLİ BARDAK BASKETLERİ

GLASS RACK EXTENDER WITH DIVIDER

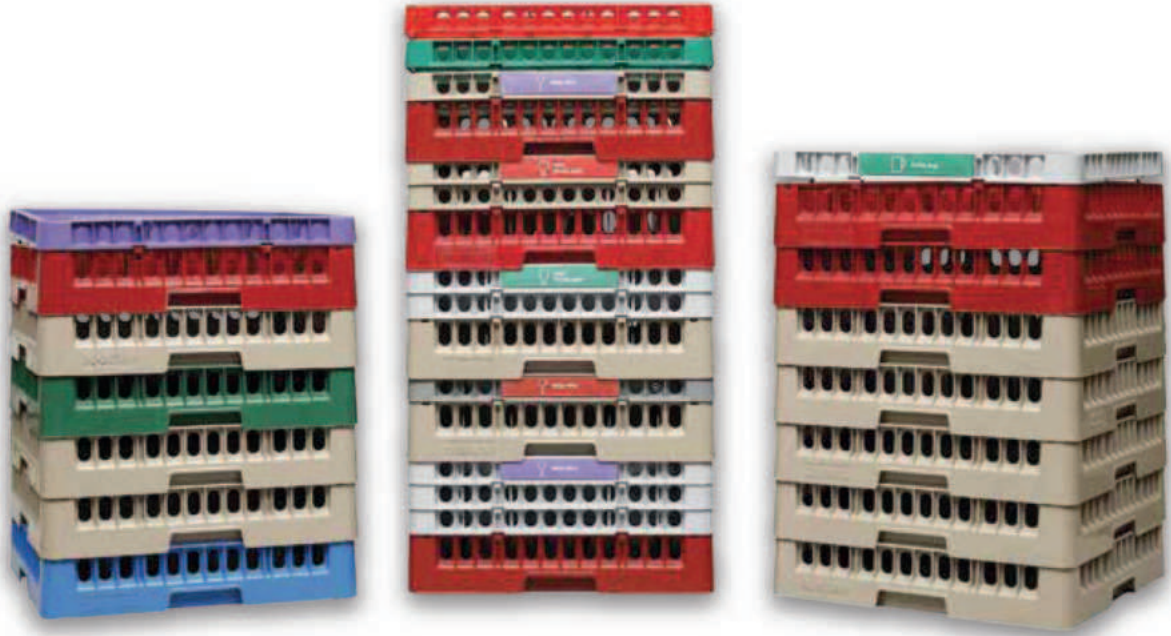

Başlıca Özellikler *Main Features*

Serigraf baskı ile bilgilendirici logolar basabiliyoruz. Ayrıca bilgilendirici şerit renkleriyle ile de bardaklarınızı sınıflandırmak için ayırım yapabilirsiniz. Rafa gerek kalmadan istifleme yapılabilir. Servis esnasında kullanılabilir.

We can print information logo and use coloured ribbon for classification your glasses. It can be used to collect dishes and glasses during the service.

BARDAK BASKETİ SEÇİM KILAVUZU

GLASS RACK SELECTING WIZARD

- 1 Bardađınızı yuvarlak alana yerleřtirin.
Place your glass in the round area.
- 2 Kapsayan ilk halkanın rengini belirleyin.
Determine the color of the first surrounding ring.
- 3 Belirlenen rengin karřılıđı olan bölme sayısını ařađıda görebilirsiniz.
You can see the number of divisions corresponding to the specified color below.

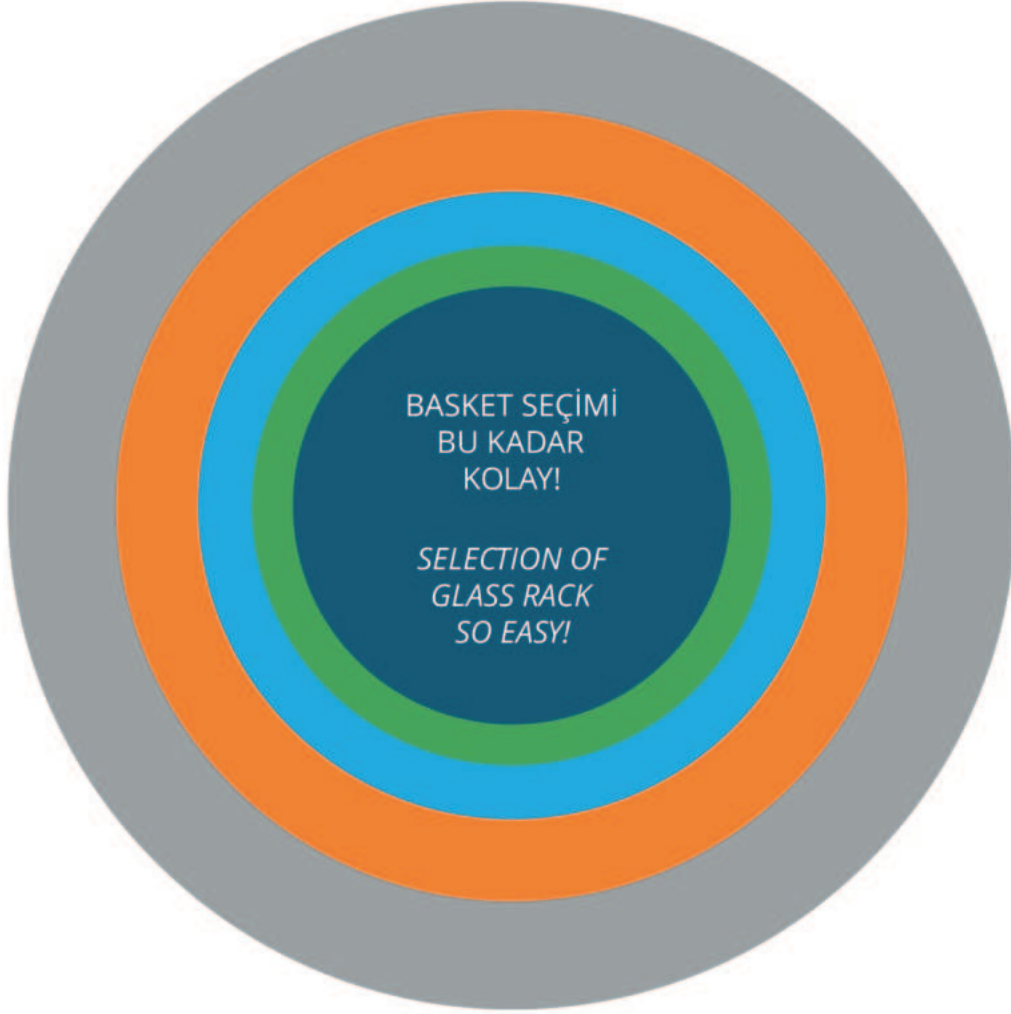

Renklere karřılık gelen bölme sayıları.
Number of divisions corresponding to the color.

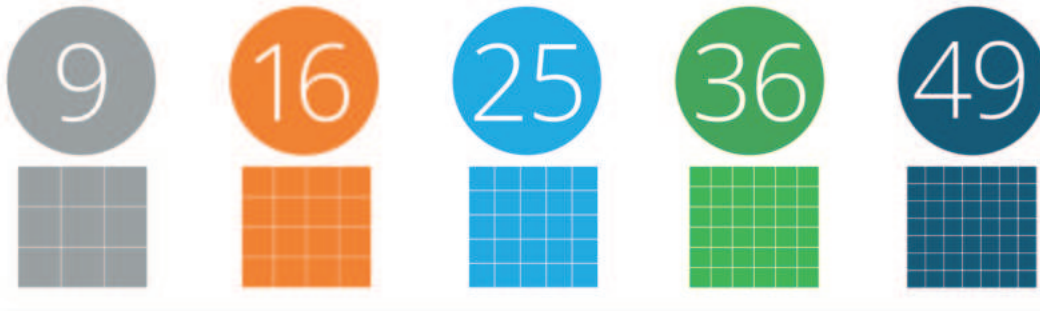

9 BÖLÜMLEYİCİLİ BARDAK BASKETİ

GLASS RACK 9 COMPARTMENT

Renkler
Colors

- RAL 7000
- RAL 3000
- RAL 1018
- RAL 6020
- RAL 5022



Kod / Code	Ürün / Product	Ölçüler (cm) / Dimensions (cm)	Koli adedi / Pcs in box	Tır / Truck	40 HC
152087608	9 Böl.Bardak Basketi / Glass Rack 9 Comp.	50,1x50,1x10,1	6	3000	2574



16 BÖLÜMLEYİCİLİ BARDAK BASKETİ

GLASS RACK 16 COMPARTMENT

Renkler
Colors

- RAL 7000
- RAL 3000
- RAL 1018
- RAL 6020
- RAL 5022



Kod / Code	Ürün / Product	Ölçüler (cm) / Dimensions (cm)	Koli adedi / Pcs in box	Tır / Truck	40 HC
152087618	16 Böl.Bardak Basketi / Glass Rack 16 Comp.	50,1x50,1x10,1	6	3000	2574



BÖLÜMLEYİCİ YÜKSELTİCİLER

EXTENDERS WITH DIVIDER

BÖLÜMLEYİCİLER

EXTENDERS WITH DIVIDER

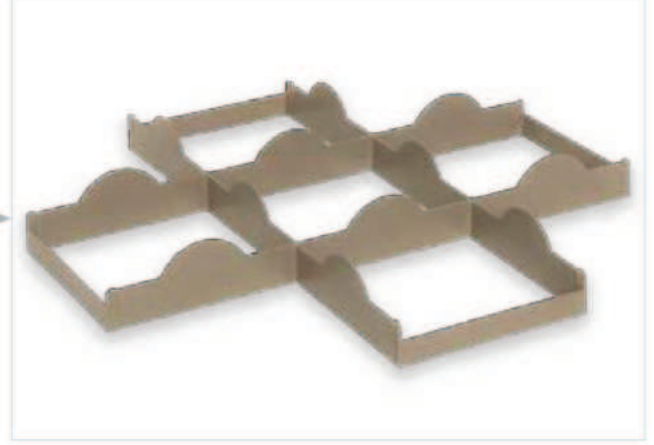

Kod / Code	Bölme Sayısı / Number of Sectio	Bölme Şekli / Dividing Shape	Bölme Ölçüsü / Dimensions (cm)	Yükseklik / Height (cm)	Koli adedi / Pcs in box	Tır / Truck	40 HC
152088108	9	3X3	15x15	8,25	12	6000	5148

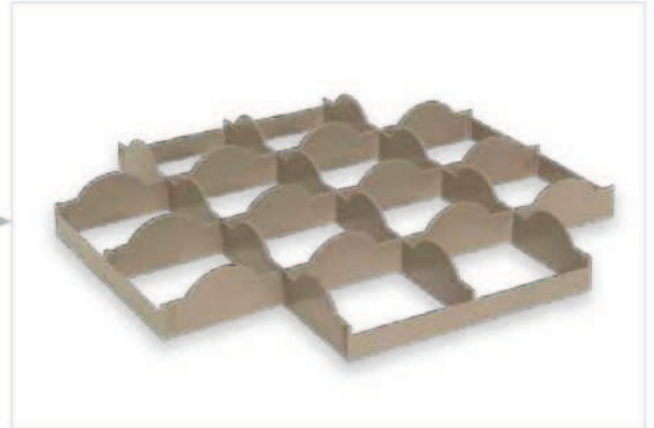

Kod / Code	Bölme Sayısı / Number of Sectio	Bölme Şekli / Dividing Shape	Bölme Ölçüsü / Dimensions (cm)	Yükseklik / Height (cm)	Koli adedi / Pcs in box	Tır / Truck	40 HC
152088118	16	4X4	11,2x11,2	8,25	12	6000	5148



25 BÖLÜMLEYİCİLİ BARDAK BASKETİ

GLASS RACK 25 COMPARTMENT

Renkler
Colors

- RAL 7000
- RAL 3000
- RAL 1018
- RAL 6020
- RAL 5022

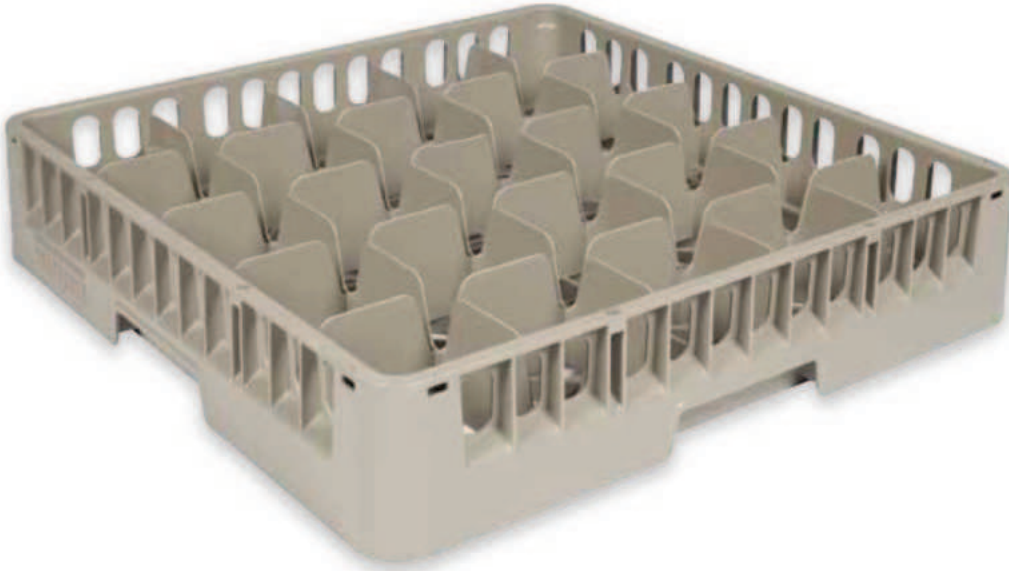

Kod / Code	Ürün / Product	Ölçüler (cm) / Dimensions (cm)	Koli adedi / Pcs in box	Tır / Truck	40 HC
152087628	25 Böl.Bardak Basketi / Glass Rack 36 Comp.	50,1x50,1x10,1	6	3000	2574



36 BÖLÜMLEYİCİLİ BARDAK BASKETİ

GLASS RACK 36 COMPARTMENT

Renkler
Colors

- RAL 7000
- RAL 3000
- RAL 1018
- RAL 6020
- RAL 5022



Kod / Code	Ürün / Product	Ölçüler (cm) / Dimensions (cm)	Koli adedi / Pcs in box	Tır / Truck	40 HC
152087638	36 Böl.Bardak Basketi / Glass Rack 36 Comp.	50,1x50,1x10,1	6	3000	2574



BÖLÜMLEYİCİ YÜKSELTİCİLER

EXTENDERS WITH DIVIDER

BÖLÜMLEYİCİLER

EXTENDERS WITH DIVIDER

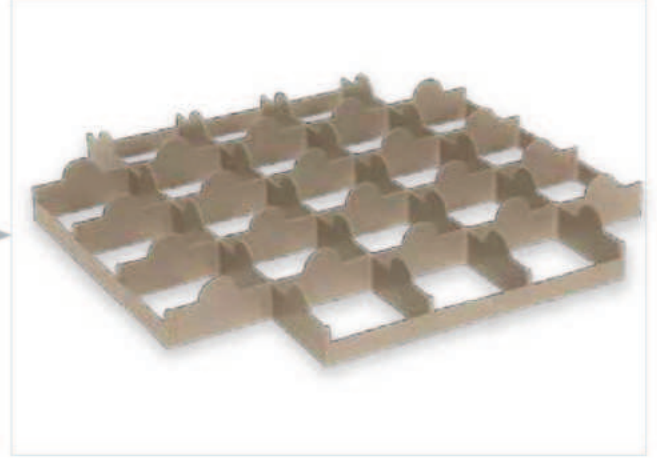

Kod / Code	Bölme Sayısı / Number of Section	Bölme Şekli / Dividing Shape	Bölme Ölçüsü / Dimensions (cm)	Yükseklik / Height (cm)	Koli adedi / Pcs in box	Tır / Truck	40 HC
152088128	25	5X5	8,9x8,9	8,25	12	6000	5148

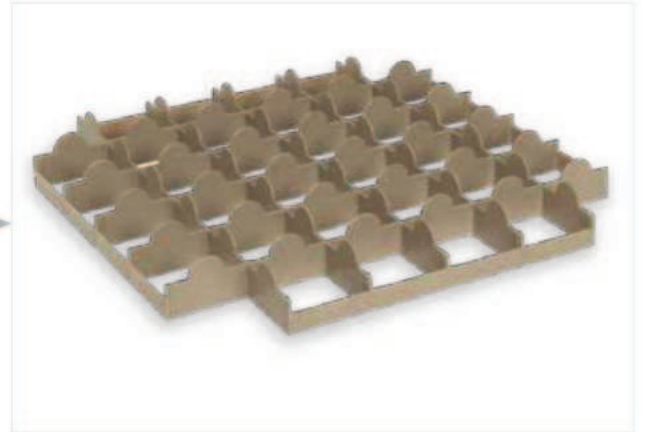
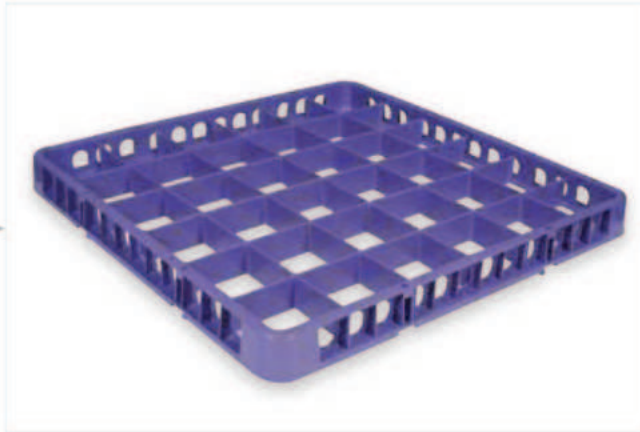

Kod / Code	Bölme Sayısı / Number of Section	Bölme Şekli / Dividing Shape	Bölme Ölçüsü / Dimensions (cm)	Yükseklik / Height (cm)	Koli adedi / Pcs in box	Tır / Truck	40 HC
152088138	36	6X6	7,4x7,4	8,25	12	6000	5148



49 BÖLÜMLEYİCİLİ BARDAK BASKETİ

GLASS RACK 49 COMPARTMENT

Renkler
Colors

- RAL 7000
- RAL 3000
- RAL 1018
- RAL 6020
- RAL 5022



Kod / Code	Ürün / Product	Ölçüler (cm) / Dimensions (cm)	Koli adedi / Pcs in box	Tır / Truck	40 HC
152087648	49 Böl.Bardak Basketi / Glass Rack 36 Comp.	50,1x50,1x10,1	6	3000	2574



BULAŞIK BASKETLERİ GENEL ÖZELLİKLERİ

DISHWASHER RACKS COMMON FEATURES

Renkler
Colors

- RAL 7000
- RAL 3000
- RAL 1018
- RAL 6020
- RAL 5022



* Özel renk üretim yapılabilir.
** Minimum sipariş detaylarını lütfen sorunuz.

* Special color production is possible.
** Please ask for minimum order details.

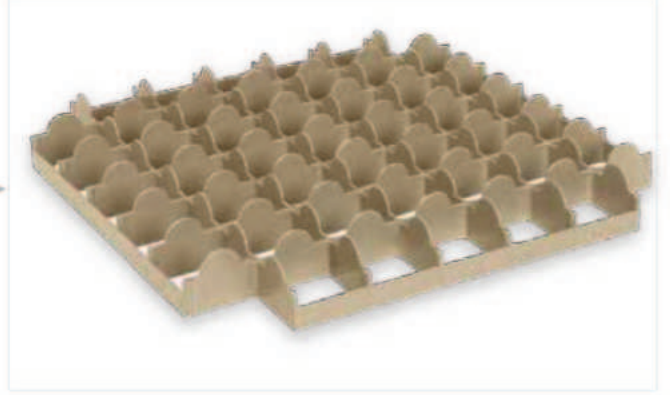

BÖLÜMLEYİCİ YÜKSELTİCİLER
EXTENDERS WITH DIVIDERBÖLÜMLEYİCİLER
EXTENDERS WITH DIVIDER

Kod / Code	Bölme Sayısı / Number of Section	Bölme Şekli / Dividing Shape	Bölme Ölçüsü / Dimensions (cm)	Yükseklik / Height (cm)	Koli adedi / Pcs in box	Tır / Truck	40 HC
152088148	49	7x7	6,2x6,2	8,25	12	6000	5148

BULAŞIK BASKETLERİ GENEL ÖZELLİKLERİ
DISHWASHER RACKS COMMON FEATURES

Özel eğimli kenarlar sayesinde maksimum temizlik sunan özel asarım.
Hole windows bottom side have been made inclined toward to take out water and waste easily from dishwasher and not keep water inside machine.



Genişletilmiş su kanalları tam kapsamlı temizlik için tasarlandı.
This elliptical shape hole specially selected to reach water massive to inside material during washing.



Yüksek miktardaki siparişlerinizde firmanıza özel logolar basabiliriz.
We can put your logo on our products for big volume orders.



En üstün kenetlenme için hassas ayarlanmış geçme boşlukları.
Edge angle has been increased to stack easy superpose each other.

products: / ürünlər

08

Taşıma Arabaları

Transport Trolleys



BULAŞIK BASKETLERİ ARABALARI
DISHWASHING BASKETS TROLLEYS

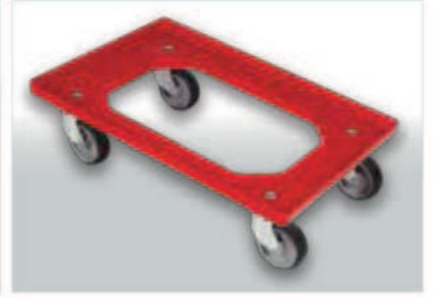
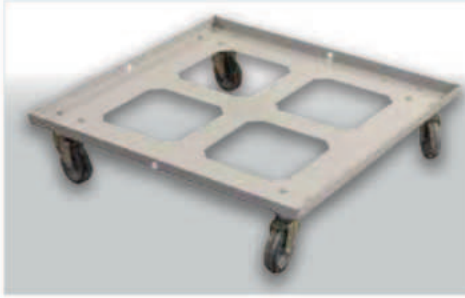

SANAYİ KASASI TAŞIMA ARABALARI
INDUSTRIAL CASE TROLLEYS

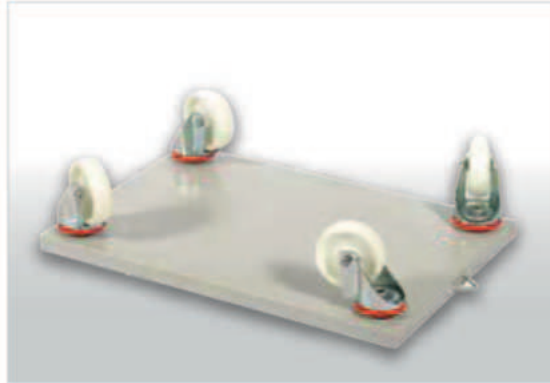
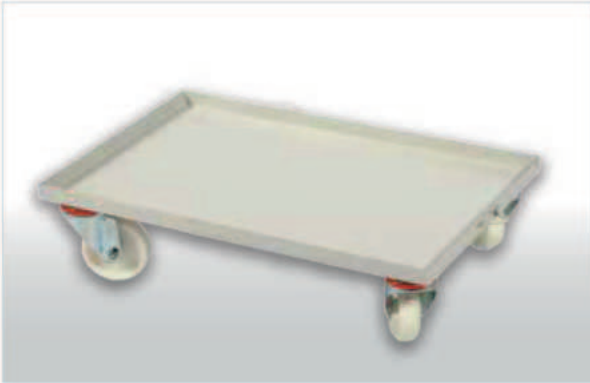

SIFIR ATIK KONTEYNER TAŞIMA ARABALARI
ZERO WASTE CONTAINER TROLLEYS

