



ROSE DURABLE

rosehantrade.com

BIOETHANOL
FIREPLACES

ELECTRIC
FIREPLACES

OUTDOOR
KITCHENS

12 CM ROUND BURNER



TECHNICAL PROPERTIES

Size	R12 x 20 cm
Burner	12 cm Burner
Liquid Volume	0,5 Liter
Burning Time	4 Hours
Heat Effect Area	10 m ²
Heating Capacity	1 kW - 3.414 BTU/h
Minimum Using Area	5 m ²
Installation Size	R11 X 7 cm
Burner Cover System	Free Cover
Note	Read Manual Before Using

25 CM ROUND BURNER



TECHNICAL PROPERTIES

Size	R25 X 20 cm
Burner	25 cm Burner
Liquid Volume	2,5 Liter
Burning Time	10 Hours
Heat Effect Area	15 m ²
Heating Capacity	1,7 kW - 5.800 BTU/h
Minimum Using Area	5 m ²
Installation Size	R18 x 10 cm
Burner Cover System	Free Cover
Note	Read Manual Before Using

20 CM BURNER



TECHNICAL PROPERTIES

Size	20 x 8,5 x 6 cm
Burner	20 cm Burner
Liquid Volume	0,5 Liter
Burning Time	3 Hours
Heat Effect Area	10 m ²
Heating Capacity	1 kW - 3.414 BTU/h
Minimum Using Area	5 m ²
Installation Size	18,5 x 6,5 x 6 cm
Burner Cover System	Free Cover
Note	Read Manual Before Using



32 CM BURNER



TECHNICAL PROPERTIES

Size	32 x 16 x 6 cm
Burner	32 cm Burner
Liquid Volume	1,5 Liters
Burning Time	5 Hours
Heat Effect Area	25 m ²
Heating Capacity	2,5 kW - 8.530 BTU/h
Minimum Using Area	10 m ²
Installation Size	31 x 14 x 6 cm
Burner Cover System	Sliding Cover
Note	Read Manual Before Using

45 CM BURNER



TECHNICAL PROPERTIES

Size	45 x 16 x 6 cm
Burner	45 cm Burner
Liquid Volume	2,5 Liters
Burning Time	7 - 8 Hours
Heat Effect Area	40 m ²
Heating Capacity	3 kW - 10.243 BTU/h
Minimum Using Area	12 m ²
Installation Size	44 x 14 x 6 cm
Burner Cover System	Sliding Cover
Note	Read Manual Before Using

BIOETHANO FIREPLACES BURNERS

BIOETHANO L FIREPLACES BURNERS



60 CM BURNER



TECHNICAL PROPERTIES

Size	60 x 16 x 6 cm
Burner	60 cm Burner
Liquid Volume	3,5 Liters
Burning Time	7 - 8 Hours
Heat Effect Area	35 m ²
Heating Capacity	4 kW - 13.657 BTU/h
Minimum Using Area	15 m ²
Installation Size	59 x 14 x 6 cm
Burner Cover System	Sliding Cover
Note	Read Manual Before Using

90 CM BURNER



TECHNICAL PROPERTIES

Size	90 x 16 x 6 cm
Burner	90 cm Burner
Liquid Volume	4,5 Liters
Burning Time	10 Hours
Heat Effect Area	45 m ²
Heating Capacity	4,4 kW - 15.000 BTU/h
Minimum Using Area	17 m ²
Installation Size	89 x 14 x 6 cm
Burner Cover System	Sliding Cover
Note	Read Manual Before Using

120 CM BURNER



TECHNICAL PROPERTIES

Size	120 x 16 x 6 cm
Burner	120 cm Burner
Liquid Volume	7 Liters
Burning Time	10 Hours
Heat Effect Area	50 m ²
Heating Capacity	5 kW - 17.072 BTU/h
Minimum Using Area	20 m ²
Installation Size	119 x 14 x 6 cm
Burner Cover System	Sliding Cover
Note	Read Manual Before Using

150 CM BURNER



TECHNICAL PROPERTIES

Size	150 x 16 x 6 cm
Burner	150 cm Burner
Liquid Volume	9 Liters
Burning Time	10 Hours
Heat Effect Area	55 m ²
Heating Capacity	5,4 kW - 18.437 BTU/h
Minimum Using Area	25 m ²
Installation Size	149 x 14 x 6 cm
Burner Cover System	Sliding Cover
Note	Read Manual Before Using

200 CM BURNER



TECHNICAL PROPERTIES

Size	150 x 16 x 6 cm
Burner	150 cm Burner
Liquid Volume	9 Liters
Burning Time	10 Hours
Heat Effect Area	55 m ²
Heating Capacity	5,4 kW - 18.437 BTU/h
Minimum Using Area	25 m ²
Installation Size	149 x 14 x 6 cm
Burner Cover System	Sliding Cover
Note	Read Manual Before Using

BIOETHANO L FIREPLACES TABLE TOP



INIZIO

TECHNICAL PROPERTIES

Size	33 x 16 x 16 cm
Burner	12 cm Burner
Liquid Volume	1 Liter
Burning Time	4 Hours
Heat Effect Area	10 m ²
Heating Capacity	1 kW - 3.414 BTU/h
Minimum Using Area	5 m ²
Installation Size	Free
Burner Cover System	Free Cover
Note	Read Manual Before Using



CONTINUA

TECHNICAL PROPERTIES

Size	34 x 23 x 16 cm
Burner	20 cm Burner
Liquid Volume	0,5 Liter
Burning Time	3 Hours
Heat Effect Area	10 m ²
Heating Capacity	1 kW - 3.414 BTU/h
Minimum Using Area	5 m ²
Installation Size	Free
Burner Cover System	Free Cover
Note	Read Manual Before Using



ROSE DURABLE



FINIRE

TECHNICAL PROPERTIES

Size	34 x 23 x 16 cm
Burner	20 cm Burner
Liquid Volume	0,5 Liter
Burning Time	3 Hours
Heat Effect Area	10 m ²
Heating Capacity	1 kW - 3.414 BTU/h
Minimum Using Area	5 m ²
Installation Size	Free
Burner Cover System	Free Cover
Note	Read Manual Before Using



METTO

TECHNICAL PROPERTIES

Size	30 x 30 x 30 cm
Burner	12 cm Burner
Liquid Volume	1 Liter
Burning Time	4 Hours
Heat Effect Area	10 m ²
Heating Capacity	1 kW - 3.414 BTU/h
Minimum Using Area	5 m ²
Installation Size	Free
Burner Cover System	Free Cover
Note	Read Manual Before Using

BIOETHANOL FIREPLACES FREE STAND



PETTO SMALL

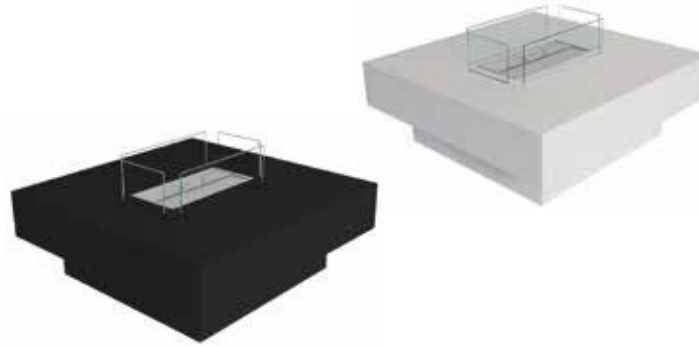

TECHNICAL PROPERTIES

Size	70 x 70 x 35 cm
Burner	32 cm Burner
Liquid Volume	1,5 Liters
Burning Time	5 Hours
Heat Effect Area	25 m ²
Heating Capacity	2,5 kW - 8.530 BTU/h
Minimum Using Area	10 m ²
Installation Size	Free
Burner Cover System	Sliding Cover
Note	Read Manual Before Using



EIFFEL

TECHNICAL PROPERTIES

Size	55 x 165 x 55 cm
Burner	32 cm Burner
Liquid Volume	1,5 Liters
Burning Time	5 Hours
Heat Effect Area	25 m ²
Heating Capacity	2,5 kW - 8.530 BTU/h
Minimum Using Area	10 m ²
Installation Size	Free
Burner Cover System	Sliding Cover
Note	Read Manual Before Using

SUPPORTO



TECHNICAL PROPERTIES

Size	100 x 60 x 30 cm
Burner	45 cm Burner
Liquid Volume	2,5 Liters
Burning Time	8 Hours
Heat Effect Area	40 m ²
Heating Capacity	3 kW - 10.243 BTU/h
Minimum Using Area	10 m ²
Installation Size	Free
Burner Cover System	Sliding Cover
Note	Read Manual Before Using



RETTAN

TECHNICAL PROPERTIES

Size	120 x 70 x 25 cm
Burner	32 cm Burner
Liquid Volume	1,5 Liters
Burning Time	5 Hours
Heat Effect Area	25 m ²
Heating Capacity	2,5 kW - 8.530 BTU/h
Minimum Using Area	10 m ²
Installation Size	Free
Burner Cover System	Sliding Cover
Note	Read Manual Before Using

**BIOETHANOL
FIREPLACES
FREE STAND**

PETTO LARGE



TECHNICAL PROPERTIES

Size	100 x 100 x 40 cm
Burner	60 cm Burner
Liquid Volume	3,5 Liters
Burning Time	7-8 Hours
Heat Effect Area	40 m ²
Heating Capacity	4 kW - 13.657 BTU/h
Minimum Using Area	15 m ²
Installation Size	Free
Burner Cover System	Sliding Cover
Note	Read Manual Before Using



TESORO

TECHNICAL PROPERTIES

Size	100 x 70 x 30 cm
Burner	60 cm Burner
Liquid Volume	3,5 Liters
Burning Time	9 Hours
Heat Effect Area	40 m ²
Heating Capacity	4 kW - 13.657 BTU/h
Minimum Using Area	15 m ²
Installation Size	Free
Burner Cover System	Sliding Cover
Note	Read Manual Before Using



AKKO



TECHNICAL PROPERTIES

Size	130 x 110 x 40 cm
Burner	60 cm Burner
Liquid Volume	3,5 Liters
Burning Time	7 - 8 Hours
Heat Effect Area	40 m ²
Heating Capacity	4 kW -13.657 BTU/h
Minimum Using Area	15 m ²
Installation Size	Free
Burner Cover System	Sliding Cover
Note	Read Manual Before Using

CAMINO



TECHNICAL PROPERTIES

Size	75 x 100 x 34 cm
Burner	32 cm Burner
Liquid Volume	1,5 Liters
Burning Time	5 Hours
Heat Effect Area	25 m ²
Heating Capacity	2,5 kW -8.530 BTU/h
Minimum Using Area	10 m ²
Installation Size	Free
Burner Cover System	Sliding Cover
Note	Read Manual Before Using

BIOETHANOL FIREPLACES FREE STAND

CAVALETTI



TECHNICAL PROPERTIES

Size	100 x 90 x 30 cm
Burner	45 cm Burner
Liquid Volume	2,5 Liters
Burning Time	8 Hours
Heat Effect Area	40 m ²
Heating Capacity	3 kW - 10.243 BTU/h
Minimum Using Area	10 m ²
Installation Size	Free
Burner Cover System	Sliding Cover
Note	Read Manual Before Using



TECHNICAL PROPERTIES

LEGNO

Size	110 x 90 x 35 cm
Burner	45 cm Burner
Liquid Volume	2,5 Liters
Burning Time	8 Hours
Heat Effect Area	40 m ²
Heating Capacity	3 kW - 10.243 BTU/h
Minimum Using Area	10 m ²
Installation Size	Free
Burner Cover System	Sliding Cover
Note	Read Manual Before Using



MONTAGNA



TECHNICAL PROPERTIES

Size	111 x R78
Burner	25 cm Burner
Liquid Volume	2,5 Liter
Burning Time	10 Hours
Heat Effect Area	15 m ²
Heating Capacity	1,7 kW - 5.800 BTU/h
Minimum Using Area	5 m ²
Installation Size	Free
Burner Cover System	Free Cover
Note	Read Manual Before Using

BIOETHANO L FIREPLACES WALL TYPE



ROSE DURABLE



ANKASTRE 80 CM

TECHNICAL PROPERTIES

Size 52 x 80 x 25
 Burner cm 32 cm
 Liquid Volume Burner
 Burning Time 1,5 Liters
 Heat Effect Area 5 Hours
 25 m

Heating Capacity 2,5 kW - 8.530 BTU/h
 Minimum Using Area 10 m²
 Installation Size 47 x 70 x 23 cm
 Burner Cover System Sliding Cover
 Note Read Manual Before Using



ANKASTRE 100 CM

TECHNICAL PROPERTIES

Size 52 x 100 x 25
 Burner cm 60 cm
 Liquid Volume Burner
 Burning Time 3,5 Liters
 Heat Effect Area 7 - 8 Hours
 40 m

Heating Capacity 4 kW - 13.657 BTU/h
 Minimum Using Area 15 m²
 Installation Size 47 x 90 x 23 cm
 Burner Cover System Sliding Cover
 Note Read Manual Before Using



ANKASTRE 130 CM

TECHNICAL PROPERTIES

Size 52 x 130 x 25
 Burner cm 90 cm
 Liquid Volume Burner
 Burning Time 4,5 Liters
 Heat Effect Area 10 Hours
 45 m²

Heating Capacity 4,4 kW - 15.000 BTU/h
 Minimum Using Area 17 m²
 Installation Size 47 x 120 x 23 cm
 Burner Cover System Sliding Cover
 Note Read Manual Before Using

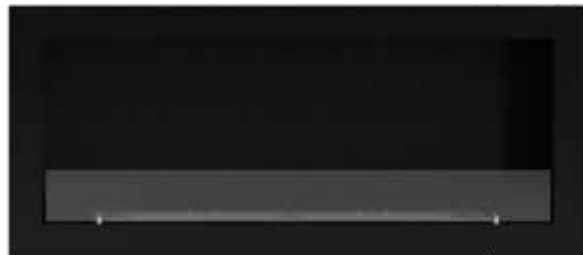

ANKASTRE 160 CM

TECHNICAL PROPERTIES

Size 52 x 160 x 25
 Burner cm 120 cm
 Liquid Volume Burner
 Burning Time 7 Liters
 Heat Effect Area 10 Hours
 50 m²

Heating Capacity 5 kW - 17.072 BTU/h
 Minimum Using Area 20 m²
 Installation Size 47 x 150 x 23 cm
 Burner Cover System Sliding Cover
 Note Read Manual Before Using



ANKASTRE 200 CM

TECHNICAL PROPERTIES

Size 52 x 200 x 25
 Mounting Space cm 45 x 190 x
 Burner 25 cm 150 cm
 Liquid Volume Burner
 Burning Time 9 Liters
 Heat Effect Area 10 Hours
 55 m²

Heating Capacity 5,4 kW - 18.437 BTU/h
 Minimum Using Area 25 m²
 Installation Size 47 x 190 x 23 cm
 Burner Cover System Sliding Cover
 Note Read Manual Before Using

BIOETHANO FIREPLACES WALL TYPE



HANGED 80 CM

TECHNICAL PROPERTIES

Size 52 x 80 x 25
 Burner cm 32 cm
 Liquid Volume Burner
 Burning Time 1,5 Liters
 Heat Effect Area 5 Hours
 25 m

Heating Capacity
 Minimum Using Area
 Installation Size
 Burner Cover System
 Note

2,5 kW - 8.530 BTU/h
 10 m²
 Free
 Sliding Cover
 Read Manual Before Using



HANGED 100 CM

TECHNICAL PROPERTIES

Size 52 x 100 x 25
 Burner cm 60 cm
 Liquid Volume Burner
 Burning Time 3,5 Liters
 Heat Effect Area 7 - 8 Hours
 40 m

Heating Capacity
 Minimum Using Area
 Installation Size
 Burner Cover System
 Note

4 kW - 13.657 BTU/h
 15 m²
 Free
 Sliding Cover
 Read Manual Before Using

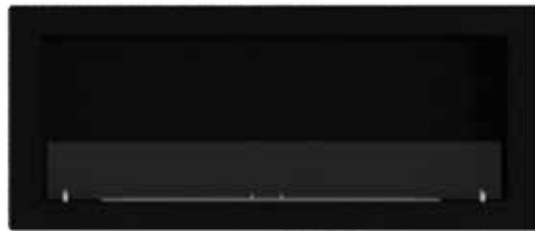

HANGED 130 CM

TECHNICAL PROPERTIES

Size 52 x 130 x 25
 Burner cm 90 cm
 Liquid Volume Burner
 Burning Time 4,5 Liters
 Heat Effect Area 10 Hours
 45 m²

Heating Capacity
 Minimum Using Area
 Installation Size
 Burner Cover System
 Note

4,4 kW - 15.000 BTU/h
 17 m²
 Free
 Sliding Cover
 Read Manual Before Using

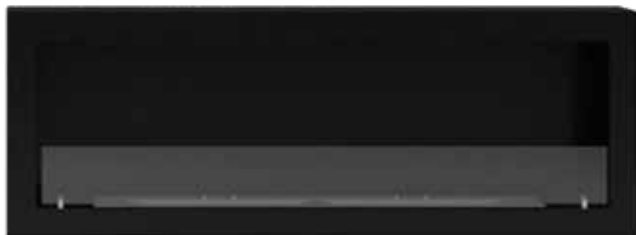

HANDEG 160 CM

TECHNICAL PROPERTIES

Size 52 x 160 x 25
 Burner cm 120 cm
 Liquid Volume Burner
 Burning Time 7 Liters
 Heat Effect Area 10 Hours
 50 m²

Heating Capacity
 Minimum Using Area
 Installation Size
 Burner Cover System
 Note

5 kW - 17.072 BTU/h
 20 m²
 Free
 Sliding Cover
 Read Manual Before Using



HANGED 200 CM

TECHNICAL PROPERTIES

Size 52 x 200 x 25
 Mounting Space cm Free
 Burner 150 cm Burner
 Liquid Volume 9 Liters
 Burning Time 10 Hours
 Heat Effect Area 55 m²

Heating Capacity
 Minimum Using Area
 Installation Size
 Burner Cover System
 Note

5,4 kW - 18.437 BTU/h
 25 m²
 Free
 Sliding Cover
 Read Manual Before Using

LEFT OPEN 80 CM

TECHNICAL PROPERTIES

Size 52 x 80 x 25
Burner cm 32 cm
Liquid Volume Burner
Burning Time 1,5 Liters
Heat Effect Area 5 Hours
25 m

Heating Capacity 2,5 kW - 8.530 BTU/h
Minimum Using Area 10 m²
Installation Size 47 x 74 x 23 cm
Burner Cover System Sliding Cover
Note Read Manual Before Using



LEFT OPEN 100 CM

TECHNICAL PROPERTIES

Size 52 x 100 x 25
Burner cm 60 cm
Liquid Volume Burner
Burning Time 3,5 Liters
Heat Effect Area 7 - 8 Hours
40 m

Heating Capacity 4 kW - 13.657 BTU/h
Minimum Using Area 15 m²
Installation Size 47 x 94 x 23 cm
Burner Cover System Sliding Cover
Note Read Manual Before Using

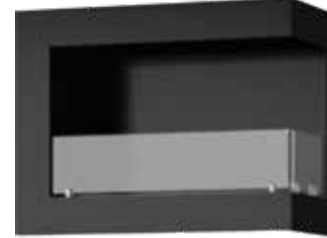

LEFT OPEN 130 CM

TECHNICAL PROPERTIES

Size 52 x 130x 25 cm
Burner 90 cm Burner
Liquid Volume 4,5 Liters
Burning Time 10 Hours
Heat Effect Area 45 m²

Heating Capacity 4,4 kW - 15.000 BTU/h
Minimum Using Area 17 m²
Installation Size 47 x 124 x 23 cm
Burner Cover System Sliding Cover
Note Read Manual Before Using



LEFT OPEN 160 CM

TECHNICAL PROPERTIES

Size 52 x 160x 25
Burner cm 120 cm
Liquid Volume Burner
Burning Time 7 Liters
Heat Effect Area 10 Hours
50 m²

Heating Capacity 5 kW - 17.072 BTU/h
Minimum Using Area 20 m²
Installation Size 47 x 154 x 23 cm
Burner Cover System Sliding Cover
Note Read Manual Before Using

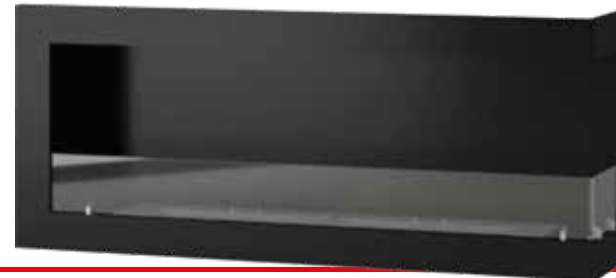

LEFT OPEN 200 CM

TECHNICAL PROPERTIES

Size 52 x 200x 25
Burner cm 150 cm
Liquid Volume Burner
Burning Time 9 Liters
Heat Effect Area 10 Hours
55 m²

Heating Capacity 5,4 kW - 18.437 BTU/h
Minimum Using Area 25 m²
Installation Size 47 x 194 x 23 cm
Burner Cover System Sliding Cover
Note Read Manual Before Using



BIOETHANO L FIREPLACES WALL TYPE



ROSE DURABLE

BIOETHANO L FIREPLACES WALL TYPE



ROSE DURABLE



RIGHT OPEN 80 CM

TECHNICAL PROPERTIES

Size 52 x 80 x 25
 Burner cm 32 cm
 Liquid Volume Burner
 Burning Time 1,5 Liters
 Heat Effect Area 5 Hours
 25 m

Heating Capacity 2,5 kW - 8.530 BTU/h
 Minimum Using Area 10 m²
 Installation Size 47 x 74 x 23 cm
 Burner Cover System Sliding Cover
 Note Read Manual Before Using



RIGHT OPEN 100 CM

TECHNICAL PROPERTIES

Size 52 x 100 x 25
 Burner cm 60 cm
 Liquid Volume Burner
 Burning Time 3,5 Liters
 Heat Effect Area 7 - 8 Hours
 40 m

Heating Capacity 4 kW - 13.657 BTU/h
 Minimum Using Area 15 m²
 Installation Size 47 x 94 x 23 cm
 Burner Cover System Sliding Cover
 Note Read Manual Before Using



RIGHT OPEN 130 CM

TECHNICAL PROPERTIES

Size 52 x 130 x 25
 Burner cm 90 cm
 Liquid Volume Burner
 Burning Time 4,5 Liters
 Heat Effect Area 10 Hours
 45 m²

Heating Capacity 4,4 kW - 15.000 BTU/h
 Minimum Using Area 17 m²
 Installation Size 47 x 124 x 23 cm
 Burner Cover System Sliding Cover
 Note Read Manual Before Using



RIGHT OPEN 160 CM

TECHNICAL PROPERTIES

Size 52 x 160 x 25
 Burner cm 120 cm
 Liquid Volume Burner
 Burning Time 7 Liters
 Heat Effect Area 10 Hours
 50 m²

Heating Capacity 5 kW - 17.072 BTU/h
 Minimum Using Area 20 m²
 Installation Size 47 x 154 x 23 cm
 Burner Cover System Sliding Cover
 Note Read Manual Before Using



RIGHT OPEN 200 CM

TECHNICAL PROPERTIES

Size 52 x 200x 25
 Burner cm 150 cm
 Liquid Volume Burner
 Burning Time 9 Liters
 Heat Effect Area 10 Hours
 55 m²

Heating Capacity 5,4 kW - 18.437 BTU/h
 Minimum Using Area 25 m²
 Installation Size 47 x 194 x 23 cm
 Burner Cover System Sliding Cover
 Note Read Manual Before Using

BIOETHANO FIREPLACES WALL TYPE



U TYPE 80 CM

TECHNICAL PROPERTIES

Size 52 x 80 x 25
 Burner cm 32 cm
 Liquid Volume Burner
 Burning Time 1,5 Liters
 Heat Effect Area 5 Hours
 25 m

Heating Capacity 2,5 kW - 8.530 BTU/h
 Minimum Using Area 10 m²
 Installation Size Free
 Burner Cover System Sliding Cover
 Note Read Manual Before Using



U TYPE 100 CM

TECHNICAL PROPERTIES

Size 52 x 100 x 25
 Burner cm 60 cm
 Liquid Volume Burner
 Burning Time 3,5 Liters
 Heat Effect Area 7 - 8 Hours
 40 m

Heating Capacity 4 kW - 13.657 BTU/h
 Minimum Using Area 15 m²
 Installation Size Free
 Burner Cover System Sliding Cover
 Note Read Manual Before Using



U TYPE 130 CM

TECHNICAL PROPERTIES

Size 52 x 130 x 25
 Burner cm 90 cm
 Liquid Volume Burner
 Burning Time 4,5 Liters
 Heat Effect Area 10 Hours
 45 m²

Heating Capacity 4,4 kW - 15.000 BTU/h
 Minimum Using Area 17 m²
 Installation Size Free
 Burner Cover System Sliding Cover
 Note Read Manual Before Using

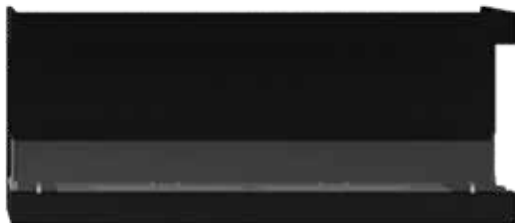

U TYPE 160 CM

TECHNICAL PROPERTIES

Size 52 x 160 x 25
 Burner cm 120 cm
 Liquid Volume Burner
 Burning Time 7 Liters
 Heat Effect Area 10 Hours
 50 m²

Heating Capacity 5 kW - 17.072 BTU/h
 Minimum Using Area 20 m²
 Installation Size Free
 Burner Cover System Sliding Cover
 Note Read Manual Before Using



U TYPE 200 CM

TECHNICAL PROPERTIES

Size 52 x 200 x 25
 Burner cm 150 cm
 Liquid Volume Burner
 Burning Time 9 Liters
 Heat Effect Area 10 Hours
 55 m²

Heating Capacity 5,4 kW - 18.437 BTU/h
 Minimum Using Area 25 m²
 Installation Size Free
 Burner Cover System Sliding Cover
 Note Read Manual Before Using

BIOETHANO FIREPLACES WALL TYPE



DOUBLE FACE 80 CM

TECHNICAL PROPERTIES

Size 52 x 80 x 25
 Burner cm 32 cm
 Liquid Volume Burner
 Burning Time 1,5 Liters
 Heat Effect Area 5 Hours
 25 m

Heating Capacity 2,5 kW - 8.530 BTU/h
 Minimum Using Area 10 m²
 Installation Size 47 x 70 x 20 cm
 Burner Cover System Sliding Cover
 Note Read Manual Before Using



DOUBLE FACE 100 CM

TECHNICAL PROPERTIES

Size 52 x 100 x 25
 Burner cm 60 cm
 Liquid Volume Burner
 Burning Time 3,5 Liters
 Heat Effect Area 7 - 8 Hours
 40 m

Heating Capacity 4 kW - 13.657 BTU/h
 Minimum Using Area 15 m²
 Installation Size 47 x 90 x 20 cm
 Burner Cover System Sliding Cover
 Note Read Manual Before Using



DOUBLE FACE 130 CM

TECHNICAL PROPERTIES

Size 52 x 130 x 25
 Burner cm 90 cm
 Liquid Volume Burner
 Burning Time 4,5 Liters
 Heat Effect Area 10 Hours
 45 m²

Heating Capacity 4,4 kW - 15.000 BTU/h
 Minimum Using Area 17 m²
 Installation Size 47 x 120 x 20 cm
 Burner Cover System Sliding Cover
 Note Read Manual Before Using



DOUBLE FACE 160 CM

TECHNICAL PROPERTIES

Size 52 x 160 x 25
 Burner cm 120 cm
 Liquid Volume Burner
 Burning Time 7 Liters
 Heat Effect Area 10 Hours
 50 m²

Heating Capacity 5 kW - 17.072 BTU/h
 Minimum Using Area 20 m²
 Installation Size 47 x 150 x 20 cm
 Burner Cover System Sliding Cover
 Note Read Manual Before Using



DOUBLE FACE 200 CM

TECHNICAL PROPERTIES

Size 52 x 200 x 25
 Burner cm 150 cm
 Liquid Volume Burner
 Burning Time 9 Liters
 Heat Effect Area 10 Hours
 55 m²

Heating Capacity 5,4 kW - 18.437 BTU/h
 Minimum Using Area 25 m²
 Installation Size 47 x 190 x 20 cm
 Burner Cover System Sliding Cover
 Note Read Manual Before Using

BIOETHANO FIREPLACES WALL TYPE



ROSE DURABLE



EPI 80 CM

TECHNICAL PROPERTIES

Size 52 x 80 x 25
 Burner cm 32 cm
 Liquid Volume Burner
 Burning Time 1,5 Liters
 Heat Effect Area 5 Hours
 25 m

Heating Capacity 2,5 kW - 8.530 BTU/h
 Minimum Using Area 10 m²
 Installation Size 47 x 74 x 20 cm
 Burner Cover System Sliding Cover
 Note Read Manual Before Using



EPI 100 CM

TECHNICAL PROPERTIES

Size 52 x 100 x 25
 Burner cm 60 cm
 Liquid Volume Burner
 Burning Time 3,5 Liters
 Heat Effect Area 7 - 8 Hours
 40 m

Heating Capacity 4 kW - 13.657 BTU/h
 Minimum Using Area 15 m²
 Installation Size 47 x 94 x 20 cm
 Burner Cover System Sliding Cover
 Note Read Manual Before Using



EPI 130 CM

TECHNICAL PROPERTIES

Size 52 x 130 x 25
 Burner cm 90 cm
 Liquid Volume Burner
 Burning Time 4,5 Liters
 Heat Effect Area 10 Hours
 45 m²

Heating Capacity 4,4 kW - 15.000 BTU/h
 Minimum Using Area 17 m²
 Installation Size 47 x 124 x 20 cm
 Burner Cover System Sliding Cover
 Note Read Manual Before Using

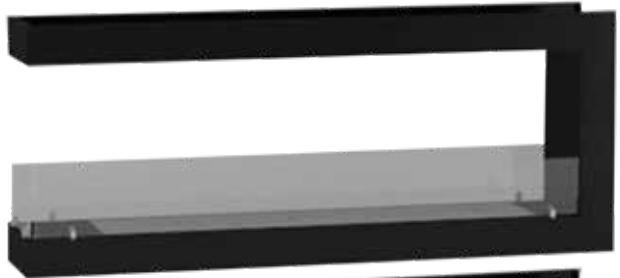

EPI 160 CM

TECHNICAL PROPERTIES

Size 52 x 160 x 25
 Burner cm 120 cm
 Liquid Volume Burner
 Burning Time 7 Liters
 Heat Effect Area 10 Hours
 50 m²

Heating Capacity 5 kW - 17.072 BTU/h
 Minimum Using Area 20 m²
 Installation Size 47 x 154 x 20 cm
 Burner Cover System Sliding Cover
 Note Read Manual Before Using



EPI 200 CM

TECHNICAL PROPERTIES

Size 52 x 200 x 25
 Burner cm 150 cm
 Liquid Volume Burner
 Burning Time 9 Liters
 Heat Effect Area 10 Hours
 55 m²

Heating Capacity 5,4 kW - 18.437 BTU/h
 Minimum Using Area 25 m²
 Installation Size 47 x 194 x 20 cm
 Burner Cover System Sliding Cover
 Note Read Manual Before Using

BIOETHANO
L
FIREPLACES
WALL TYPE



ROSE DURABLE

KW036-PRISM



TECHNICAL PROPERTIES

Size	100 x 60 x 25 cm
Burner	45 cm Burner
Liquid Volume	2,5 Liters
Burning Time	7 - 8 Hours
Heat Effect Area	30 m ²
Heating Capacity	3 kW - 10.243 BTU/h
Minimum Using Area	12 m ²
Installation Size	Free
Burner Cover System	Sliding Cover
Note	Read Manual Before Using

KW037-SOFF



TECHNICAL PROPERTIES

Size	190 x 70 x 70 cm
Burner	Special Burner
Liquid Volume	3,5 Liters
Burning Time	8 - 9 Hours
Heat Effect Area	35 m ²
Heating Capacity	4 kW - 13.657 BTU/h
Minimum Using Area	15 m ²
Installation Size	Free
Burner Cover System	Free Cover
Note	Read Manual Before Using



ROSE DURABLE

rosehantrade.com

ELECTRIC
FIREPLACE

ELECTRIC FIREPLACES

ELECTRIC
FIREPLACES **BUILT-IN**
WITHOUT HEATER

MOBILE
APPLICATION CONTROL



7 COLORS
RGB



SHINING
CONTROL
FLAME & WOOD



TIMER
UP TO 6 HOURS



MUSIC
10 STOCK

ELECTRIC
FIREPLACES **BUILT-IN**
WITH HEATER

MOBILE
APPLICATION CONTROL



7 COLORS
RGB



HEATER
1000-2000W

SHINING
CONTROL
FLAME & WOOD



TIMER
UP TO 6 HOURS



MUSIC
10 STOCK



ELECTRIC
FIREPLACES **BUILT-IN**
WITH HEATER

ELECTRIC FIREPLACES



KORCAM S 80 CM



TECHNICAL PROPERTIES

Size	80 x 25 x 52
Installation Size	cm 77 x 23 x
Bluetooth	49 cm Yes
Heating	Yes
Mobile Application	Yes
Sound Effects	Yes
Timer	Yes
Remote Controller	No
Flame Effect	Yes
Wood Effect	No
RGB	7 Colors
Warranty	2 Years



ROSE DURABLE

KORCAM S 100 CM



TECHNICAL PROPERTIES

Size	100 x 24 x 52 cm
Installation Size	97 x 23 x 49 cm
Bluetooth	Yes
Heating	Yes
Mobile Application	Yes
Sound Effects	Yes
Timer	Yes
Remote Controller	No
Flame Effect	Yes
Wood Effect	No
RGB	7 Colors
Warranty	2 Years



TECHNICAL PROPERTIES

Size	160 x 24 x 52
Installation Size	cm 157 x 23 x
Bluetooth	49 cm Yes
Heating	Yes
Mobile Application	Yes
Sound Effects	Yes
Timer	Yes
Remote Controller	No
Flame Effect	Yes
Wood Effect	No
RGB	7 Colors
Warranty	2 Years

KORCAM S 130 CM



TECHNICAL PROPERTIES

Size	130 x 24 x 52
Installation Size	cm 127 x 23 x
Bluetooth	49 cm Yes
Heating	Yes
Mobile Application	Yes
Sound Effects	Yes
Timer	Yes
Remote Controller	No
Flame Effect	Yes
Wood Effect	No
RGB	7 Colors
Warranty	2 Years



TECHNICAL PROPERTIES

Size	200 x 24 x 52
Installation Size	cm 197 x 23 x
Bluetooth	49 cm Yes
Heating	Yes
Mobile Application	Yes
Sound Effects	Yes
Timer	Yes
Remote Controller	No
Flame Effect	Yes
Wood Effect	No
RGB	7 Colors
Warranty	2 Years

ELECTRIC FIREPLACES

ELECTRIC
FIREPLACES **BUILT-IN**
WITHOUT HEATER

ROSE DURABLE



KORCAM ECO 80 CM

TECHNICAL PROPERTIES

Size	81.5 x 42 x 21
Installation Size	Cm 70 x 39 x 20
Bluetooth	Cm Yes
Heating	No
Mobile Application	Yes
Sound Effects	Yes
Timer	Yes
Remote Controller	No
Flame Effect	Yes
Wood Effect	No
RGB	7 Colors
Warranty	2 Years

KORCAM ECO 100 CM



TECHNICAL PROPERTIES

Size	101,5 x 42 x 21 cm
Installation Size	90 x 39 x 20 cm
Bluetooth	Yes
Heating	No
Mobile Application	Yes
Sound Effects	Yes
Timer	Yes
Remote Controller	No
Flame Effect	Yes
Wood Effect	No
RGB	7 Colors
Warranty	2 Years



TECHNICAL PROPERTIES

Size	156,5 x 42 x 21 cm
Installation Size	145 x 39 x 20 cm
Bluetooth	Yes
Heating	No
Mobile Application	Yes
Sound Effects	Yes
Timer	Yes
Remote Controller	No
Flame Effect	Yes
Wood Effect	No
RGB	7 Colors
Warranty	2 Years

KORCAM ECO 130 CM



TECHNICAL PROPERTIES

Size	131,5 x 42 x 21 cm
Installation Size	120 x 39 x 20 cm
Bluetooth	Yes
Heating	No
Mobile Application	Yes
Sound Effects	Yes
Timer	Yes
Remote Controller	No
Flame Effect	Yes
Wood Effect	No
RGB	7 Colors
Warranty	2 Years



TECHNICAL PROPERTIES

Size	181,5 x 42 x 21 cm
Installation Size	170 x 39 x 20 cm
Bluetooth	Yes
Heating	No
Mobile Application	Yes
Sound Effects	Yes
Timer	Yes
Remote Controller	No
Flame Effect	Yes
Wood Effect	No
RGB	7 Colors
Warranty	2 Years

KORMET S 80 CM



TECHNICAL PROPERTIES

Size	80 x 25 x 52
Installation Size	cm 76 x 23 x 49 cm
Bluetooth	Yes
Heating	Yes
Mobile Application	Yes
Sound Effects	Yes
Timer	Yes
Remote Controller	No
Flame Effect	Yes
Wood Effect	No
RGB	7 Colors
Warranty	2 Years



TECHNICAL PROPERTIES

Size	130 x 24 x 52
Installation Size	cm 125 x 23 x 49 cm
Bluetooth	Yes
Heating	Yes
Mobile Application	Yes
Sound Effects	Yes
Timer	Yes
Remote Controller	No
Flame Effect	Yes
Wood Effect	No
RGB	7 Colors
Warranty	2 Years

KORMET S 100 CM



TECHNICAL PROPERTIES

Size	100 x 24 x 52
Installation Size	cm 95 x 23 x 49 cm
Bluetooth	Yes
Heating	Yes
Mobile Application	Yes
Sound Effects	Yes
Timer	Yes
Remote Controller	No
Flame Effect	Yes
Wood Effect	No
RGB	7 Colors
Warranty	2 Years



TECHNICAL PROPERTIES

Size	160 x 24 x 52
Installation Size	cm 155 x 23 x 49 cm
Bluetooth	Yes
Heating	Yes
Mobile Application	Yes
Sound Effects	Yes
Timer	Yes
Remote Controller	No
Flame Effect	Yes
Wood Effect	No
RGB	7 Colors
Warranty	2 Years

ELECTRIC FIREPLACES



KORMET S 180 CM

TECHNICAL PROPERTIES

Size	80 x 25 x 52
Installation Size	cm 76 x 23 x
Bluetooth	49 cm Yes
Heating	Yes
Mobile Application	Yes
Sound Effects	Yes
Timer	Yes
Remote Controller	No
Flame Effect	Yes
Wood Effect	No
RGB	7 Colors
Warranty	2 Years

ELECTRIC FIREPLACES

ELECTRIC
FIREPLACES **BUILT-IN**
WITH HEATER

ROSE DURABLE

KORMET ECO 80 CM

TECHNICAL PROPERTIES

Size	81.5 x 42 x 21
Installation Size	Cm 70 x 39 x 20
Bluetooth	Cm Yes
Heating	No
Mobile Application	Yes
Sound Effects	Yes
Timer	Yes
Remote Controller	No
Flame Effect	Yes
Wood Effect	No
RGB	7 Colors
Warranty	2 Years

KORMET ECO 100 CM



TECHNICAL PROPERTIES

Size	101,5 x 42 x 21 cm
Installation Size	90 x 39 x 20 cm
Bluetooth	Yes
Heating	No
Mobile Application	Yes
Sound Effects	Yes
Timer	Yes
Remote Controller	No
Flame Effect	Yes
Wood Effect	No
RGB	7 Colors
Warranty	2 Years



TECHNICAL PROPERTIES

Size	156,5 x 42 x 21 cm
Installation Size	145 x 39 x 20 cm
Bluetooth	Yes
Heating	No
Mobile Application	Yes
Sound Effects	Yes
Timer	Yes
Remote Controller	No
Flame Effect	Yes
Wood Effect	No
RGB	7 Colors
Warranty	2 Years

KORMET ECO 130 CM



TECHNICAL PROPERTIES

Size	131,5 x 42 x 21 cm
Installation Size	120 x 39 x 20 cm
Bluetooth	Yes
Heating	No
Mobile Application	Yes
Sound Effects	Yes
Timer	Yes
Remote Controller	No
Flame Effect	Yes
Wood Effect	No
RGB7 Colors	
Warranty	2 Years



TECHNICAL PROPERTIES

Size	181,5 x 42 x 21 cm
Installation Size	170 x 39 x 20 cm
Bluetooth	Yes
Heating	No
Mobile Application	Yes
Sound Effects	Yes
Timer	Yes
Remote Controller	No
Flame Effect	Yes
Wood Effect	No
RGB	7 Colors
Warranty	2 Years



ROSE DURABLE

rosehantrade.com

OUTDOOR
KITCHEN
S

PURE SERIES OUTDOOR KITCHENS

MATERIAL LIST

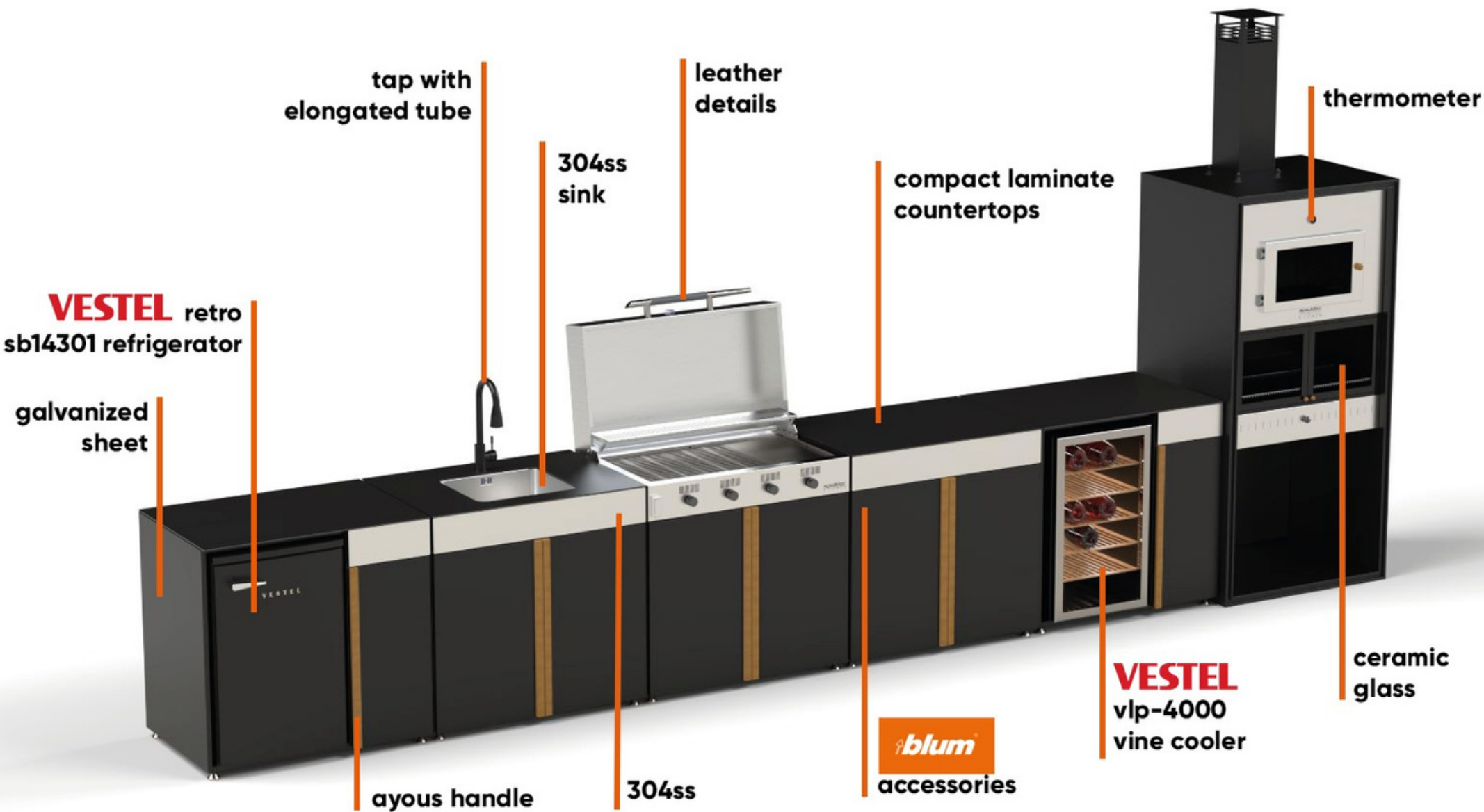

tap with
elongated tube

leather
details

304ss
sink

compact laminate
countertops

thermometer

VESTEL retro
sb14301 refrigerator

galvanized
sheet

ayoux handle

304ss

blum
accessories

VESTEL
vlp-4000
wine cooler

ceramic
glass



PURE SERIES OUTDOOR KITCHENS



183 cm

90 cm
BARBEQUE
90X183X70CM

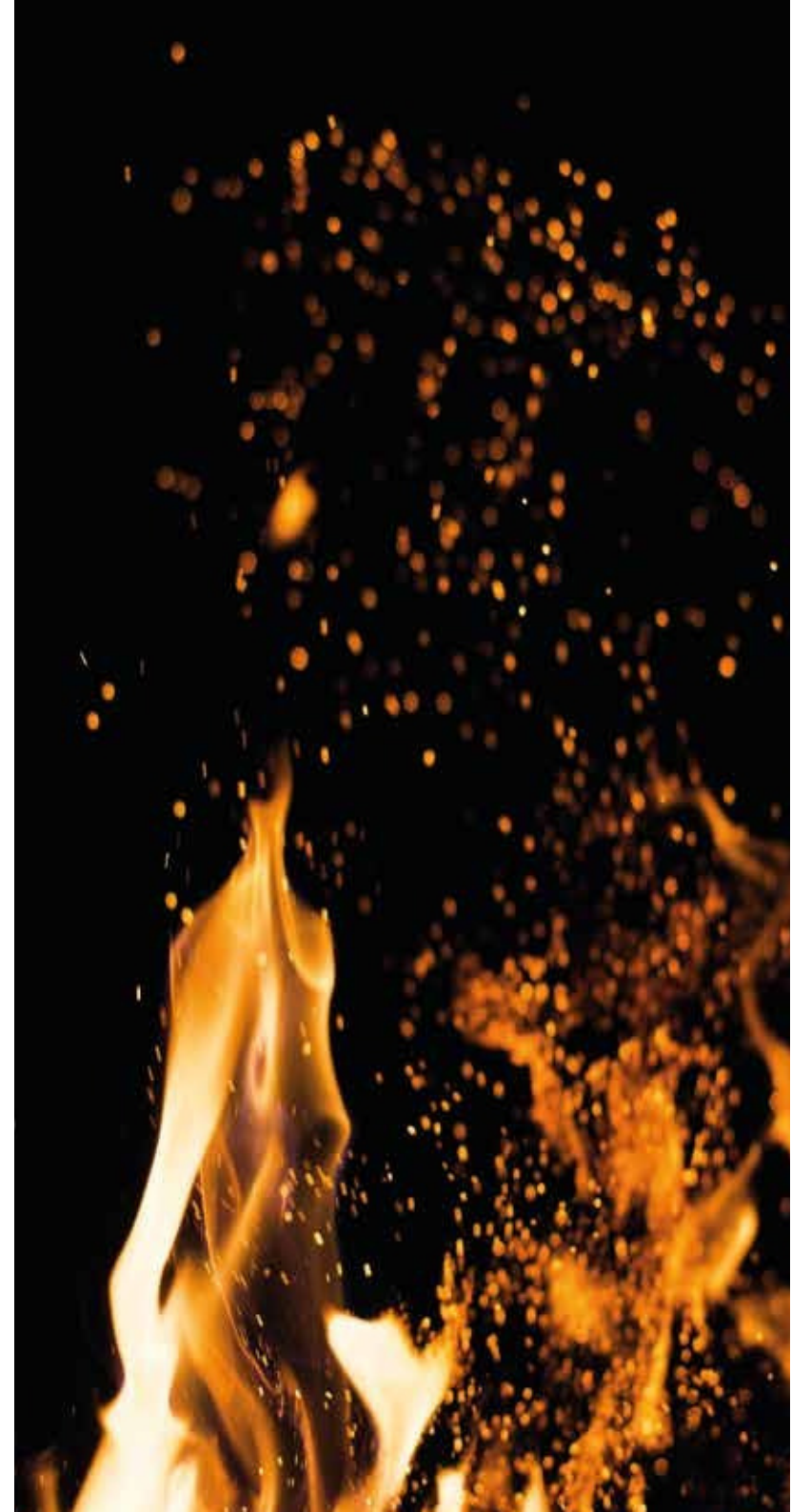

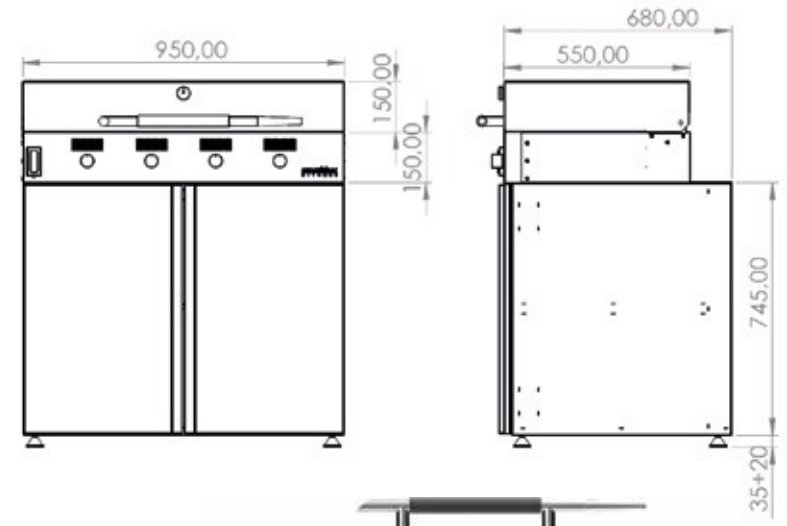

PURE SERIES
OUTDOOR KITCHENS
WITH GAS BBQ

95 CM
PURE COOKER
95X105X68CM



PURE SERIES OUTDOOR KITCHENS

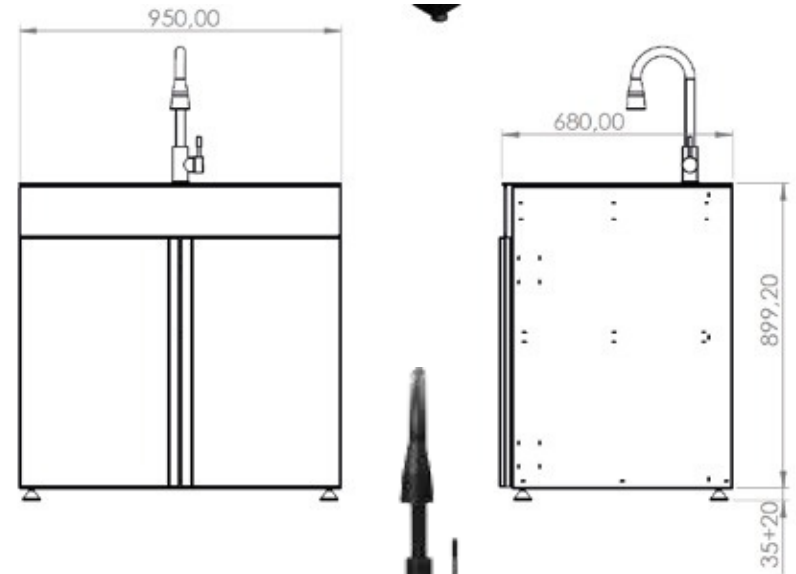

**95 CM
PURE
WASHER
95X90X68CM**



PURE SERIES OUTDOOR KITCHENS

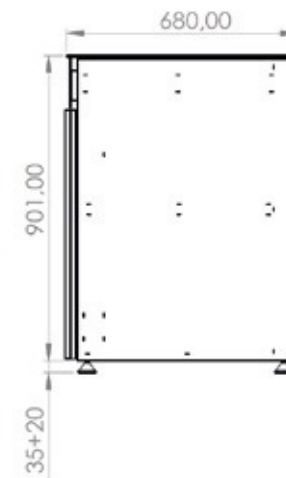
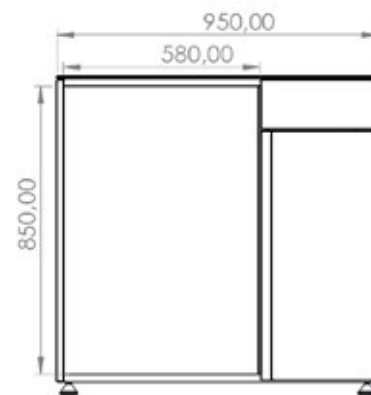

**95 CM
PURE
COOLER
95X90X68CM**



PURE SERIES OUTDOOR KITCHENS

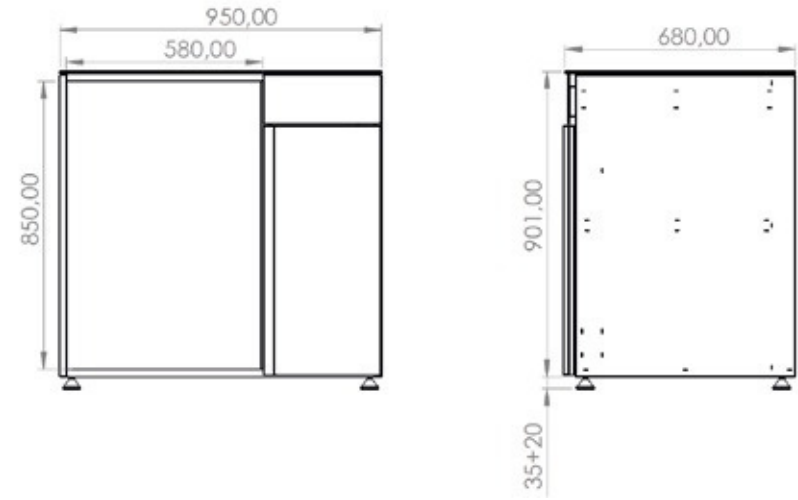

**95 CM
PURE
WINE
95X90X68CM**



PURE SERIES
OUTDOOR KITCHENS



ROSE DURABLE

95 CM
PURE
DISHWASHER
95X90X68CM

PURE SERIES
OUTDOOR KITCHENS



ROSE DURABLE

95 CM
PURE
DRAWER
60X90X68CM

PURE SERIES
OUTDOOR KITCHENS
WITH GAS BBQ

95 CM
PURE
CORNER MODULE
68X90X68CM



ROSE DURABLE

PURE SERIES OUTDOOR KITCHENS WITH GAS BBQ



95 CM
PURE
COOK MODULE
95X30X55CM

