

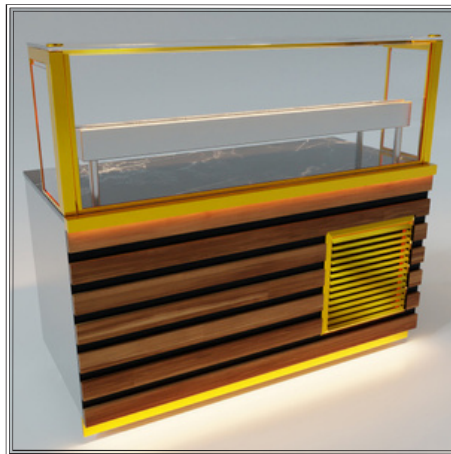

**RoseBuild**

**ÜRÜN KATALOĐU**  
PRODUCT CATALOGUE

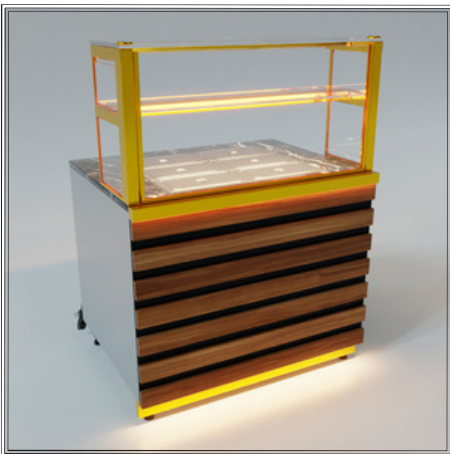





<b>630 LUK SERİ / 630 SERIES</b> / Série des 630	<b>7 -23</b>
<b>700 LÜK SERİ / 700 SERIES</b> / Série des 700	<b>24-49</b>
<b>930 LUK SERİ / 930 SERIES</b> / Série des 930	<b>50-71</b>
<b>KAFETERYA / CAFE / Cafeterias</b>	<b>72-80</b>
<b>KUZİNELER / RANGES / Cuisinières</b>	<b>81-85</b>
<b>KOSAN OCAKLARI / STOVES / Cusinière à Sol</b>	<b>86-87</b>
<b>WOK OCAKLAR/ WOK COOCKERS</b> / Cuiser Wok	<b>88-89</b>
<b>FIRINLAR / OVENS / Fours</b>	<b>90-92</b>
<b>PİZZA FIRINLARI / PIZZA OVENS</b> / Fours à Pizza	<b>93-95</b>
<b>SOĞUK ÜNİTELER / COLD UNITS / Unités Froides</b>	<b>96-121</b>
<b>İÇECEK DİSPANSERLERİ / BEVERAGE DISPANSERS</b> / Dispansaires De Bosisons	<b>122-123</b>
<b>ÇAY OCAKLARI / TEA KITCHENS</b> / Cuisines A Thes	<b>124-125</b>
<b>ET &amp; KIYMA MAKİNALARI / MEAT &amp; MINCING MACHINES</b>	<b>126-129</b>
<b>BULAŞIK MAKİNELERİ / DISHWASHER / Lave -Verre</b>	<b>130-135</b>
<b>TEZGAHLAR / BENCHES / Comptoirs</b>	<b>136-139</b>
<b>BAR MODÜLLERİ / BENCHES / Comptoirs</b>	<b>140-145</b>



**630**      **LUK**  
**SERİ**     **630**  
**SERIES** / Série des 630



A photograph of a commercial kitchen unit, likely a range hood or oven, with a white upper section and a stainless steel lower section. The unit features several control knobs and a digital display on the right side. The image is overlaid with a semi-transparent orange rectangle.

# 630 LUK SERİ

## 630 SERIES

### Série des 630



TEKLİ BÜYÜK FRİTÖZ / SINGLE BIG FRYER / GRANDE FRITEUSE 1 BAC



- TR
- Paslanmaz çelik gövde
  - Hareketli ısıtıcılar sayesinde kolay temizlik - Hijyenik
  - 100-180 °C ayarlı termostat
  - Ayarlanabilir ayaklar
  - Uzun ömürlü
  - Set üstü olarak kullanılır

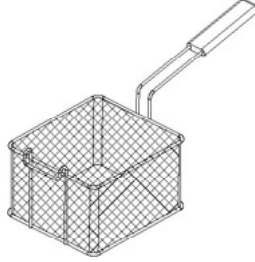

GAST-6FE27

ÇİFTLİ MİNİ FRİTÖZ / DOUBLE SMALL FRYER / PETITE FRITEUSE 2 BACS



- EN
- Stainless steel body
  - Easy to clean
  - Hygienic
  - 100-180 °C Adjustable thermostat - Adjustable legs
  - Long life
  - Using over bench



GAST-6FE35

ÇİFTLİ BÜYÜK FRİTÖZ / DOUBLE BIG FRYER / GRANDE FRITEUSE 2 BACS



- FR
- Boîtier en acier inoxydable
  - Nettoyage facile avec chauffage mobile
  - Hygiénique
  - Thermostat réglable 100°C- 180°C
  - Pieds soutien réglable
  - Longue durée de vie
  - Utilisable sur planche

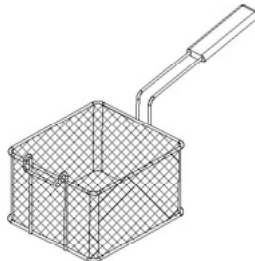

GAST-6FE55

40 LİK TEKLİ ELEKTRİKLİ FRİTÖZ / ELECTRIC FRYER / FRITEUSE



- TR** - Paslanmaz çelik gövde  
- Hareketli ısıtıcılar sayesinde kolay temizlik -  
Hijyenik  
- Tahliye Vanası  
- Yekpare bankolu havuz  
- Emniyet termostatu  
- 100-180 °C ayarlı termostat  
- Ayarlanabilir ayaklar  
- Uzun ömürlü  
- Set üstü olarak kullanılır



GAST-6FE40

- EN** - Stainless steel body  
- Easy to clean  
- Hygienic  
- With drainage pipe  
- Monoblock bowl  
- Safety thermostat  
- 100-180 °C Adjustable  
thermostat - Adjustable legs  
- Long life  
- Using over bench

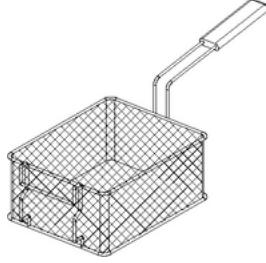

60 LİK ÇİFTLİ ELEKTRİKLİ FRİTÖZ / ELECTRIC FRYER / FRITEUSE



- FR** - Boitier en acier inoxydable  
- Nettoyage facile avec chauffage mobile -  
Hygiénique  
- Soupape d'évacuation  
- Bac monobloc  
- Thermostat de sécurité  
- Thermostat réglable 100°C- 180°C  
- Pieds soutien réglable  
- Longue durée de vie  
- Utilisable sur planche



GAST-6FE60



40 LİK TEKLİ ELEKTRİKLİ DİJİTAL FRİTÖZ / ELECTRIC DIGITAL FRYER / PG ⚡ CE

- TR**
- Paslanmaz çelik gövde
  - Hareketli ısıtıcılar sayesinde kolay temizlik - Hijyenik
  - Tahliye Vanası
  - Yekpare bankolu havuz
  - Emniyet termostadı
  - 100-180 °C ayarlı dijital termostat
  - Ayarlanabilir ayaklar
  - Uzun ömürlü
  - Set üstü olarak kullanılır



GAST-6FED40

- EN**
- Stainless steel body
  - Easy to clean
  - Hygienic
  - With drainage pipe
  - Monoblock bowl
  - Safety thermostat
  - 100-180 °C Adjustable digital thermostat - Adjustable legs
  - Long life
  - Using over bench

60 LİK ÇİFTLİ ELEKTRİKLİ DİJİTAL FRİTÖZ / ELECTRIC DIGITAL FRYER / PG ⚡ CE

- FR**
- Boîtier en acier inoxydable
  - Nettoyage facile avec chauffage mobile
  - Hygiénique
  - Soupape d'évacuation
  - Bac monobloc
  - Thermostat de sécurité
  - Thermostat digital réglable 100°C- 180°C -
  - Pieds soutien réglable
  - Longue durée de vie
  - Utilisable sur planche



GAST-6FED60

FRITEUSE DIGITAL

40 LİK GAZLI FRİTÖZ / GAS FRYER / GRANDE FRITEUSE A GAZ



- TR**
- Paslanmaz çelik gövde
  - Piezoelektrik ateşlemeli pilot
  - LPG ve Doğalgaz uyumlu
  - Yekpare bankolu havuz
  - Emniyet termostatu
  - 100°C-180°C ayarlı termostat
  - 8 lt yağ kapasitesi
  - Ayarlanabilir ayaklar
  - Set üstü ve dolaplı kullanıma uygundur.



GAST-6FG40

- EN**
- Stainless steel body
  - Safety gas thermostat 100°C-180°C
  - Piezoelectric ignition and pilot flame
  - Available for LPG and Natural Gas
  - Monoblock bowl
  - 8 lt frying capacity
  - Available legs
  - Using over bench

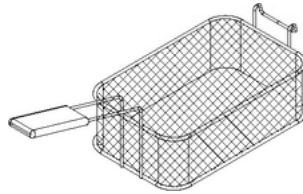

60 LİK GAZLI FRİTÖZ / GAS FRYER / GRANDE FRITEUSE A GAZ



- FR**
- Adaptable à fonctionner au GPL ou GN.
  - Commande thermostatique.
  - Panier en acier inoxydable.
  - Robinet de sécurité magnétique.
  - Vanne de vidange d'huile.
  - Sécurité du thermostat contre la surchauffe.
  - Nettoyage facile grâce à la conception hygiénique.
  - Corps en acier inoxydable



GAST-6FG60



2 Lİ GAZLI OCAK / GAS COOKER WITH 2 BURNERS / CUISINIÈRE GAZ A 2 BRÛLEURS



- TR**
- Paslanmaz çelik gövde
  - Alev denetleme tertibatı ve pilot yanış sistemi - Sanayi tipi döküm
  - LPG ve Doğalgaza uyumlu
  - Ayarlanabilir ayaklar
  - Kolay temizlenebilir
  - Set üstü olarak kullanılır.

- EN**
- Stainless steel body
  - Valves able to control max and min - Heavy duty top cast iron
  - Available LPG or Natural Gas
  - Adjustable legs
  - Easy to clean
  - Using over bench



GAST-60CG40

4 LÜ GAZLI OCAK / GAS COOKER WITH 4 BURNERS / CUISINIÈRE GAZ A 4 BRÛLEURS



- FR**
- Boîtier en acier inoxydable
  - Commande des valves au max/min - Fonte de type industriel
  - Compatible au GPL et gaz naturel
  - Pieds soutien réglable
  - Nettoyage facile
  - Utilisable sur planche



GAST-60CG60

2 Lİ ELEKTRİKLİ OCAK / ELECTRIC COOKER 2 HOT PLATES /



TR

- Paslanmaz çelik gövde
- Pik dökümlü 20 cm pleytler
- 3 kademeli kontrol edilebilir
- Ayarlanabilir ayaklar
- Kolay temizlenebilir.
- Set üstü olarak kullanılır.

EN

- Stainless steel body
- 20 cm diameter heaters
- Adjustable control system
- Adjustable legs
- Easy to clean
- Using over bench

CUISINIÈRE ELECTRIQUE A 2 PLAQUES CHAUFFANTES



GAST-60CE40

4 LÜ ELEKTRİKLİ OCAK / ELECTRIC COOKER 4 HOT PLATES /



FR

- Boîtier en acier inoxydable
- Les plates de fonte à 20 cm
- Contrôle à 3 niveaux graduels -
- Pieds soutien réglable
- Nettoyage facile
- Utilisable sur planche

CUISINIÈRE ELECTRIQUE A 4 PLAQUES CHAUFFANTES



GAST-60CE60

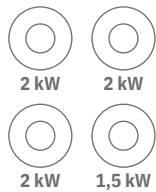



## 630 LUK SERİ / 630 SERIES / SÉRIE DES 630 GAZLI IZGARALAR / GAS GRILL PLATES / GRILL A GAZ

### 40 LİK GAZLI IZGARA / GAS GRILL PLATE / GRILL A GAZ



- TR - Paslanmaz çelik gövde
- LPG ve Doğalgaza uyumlu
- Pişirme yüzeyi düz, yarı oluklu ve oluklu olarak 3 model
- 80'lik modellerde ayrı ayrı kontrol edilebilen pişirme yüzeyi - Piezoelektrik ateşlemeli, pilotlu
- Ayarlanabilir ayaklar
- Homojen pişirme yüzeyi
- Yağ toplama kanalı, boşaltma çekmecesi
- Kolay temizlenebilir
- Set üstü olarak kullanılır



GAST-6PIG40YO

### 60 LİK GAZLI IZGARA / GAS GRILL PLATE / GRILL A GAZ



- EN - Stainless steel body
- Available LPG or Natural Gas
- Types of cooking plate (smooth, 1/2 nervour and nervour) - Cooking zone is controlled by 2 different valves separately
- Piezoelectric ignition, pilot flame
- Adjustable legs
- Equal temperature distribution on the cooking surface
- Fat collecting drawer
- Easy to clean
- Using over bench



GAST-6PIG60YO

### 80 LİK GAZLI IZGARA / GAS GRILL PLATE / GRILL A GAZ



- FR - Boîtier en acier inoxydable
- Nettoyage facile avec chauffage mobile
- Modèles 80 cm contrôle cuisson séparable pour surface plate, demi lisse, demi rainuré
- Cuisson surface plate réglable
- Pieds réglable
- Cuisson homogène surface plate
- Canal de collecte de graisse-tiroir déchargeur
- Nettoyage facile
- Utilisable sur planche



GAST-6PIG80YO

## 630 LUK SERİ / 630 SERIES / SÉRIE DES 630

### GAZLI KROM IZGARALAR / GAS CHROME GRILL PLATES / GRILL A GAZ CHORME

#### 40 LİK KROM GAZLI IZGARA / GAS CHROME GRILL PLATE /



- TR**
- Paslanmaz çelik gövde
  - LPG ve Doğalgaza uyumlu
  - Pişirme yüzeyi düz, yarı oluklu ve oluklu olarak 3 model
  - 80'lik modellerde ayrı ayrı kontrol edilebilen pişirme yüzeyi - Piezoelektrik ateşlemeli, pilotlu
  - Ayarlanabilir ayaklar
  - Homojen pişirme yüzeyi
  - Yağ toplama kanalı, boşaltma çekmecesi
  - Kolay temizlenebilir
  - Set üstü olarak kullanılır



GAST-6PIG40KYO

#### 60 LİK KROM GAZLI IZGARA / GAS CHROME GRILL PLATE / GRILL A GAZ CHROME



- EN**
- Stainless steel body
  - Available LPG or Natural Gas
    - Types of cooking plate (smooth, 1/2 nervour and nervour)
    - Cooking zone is controlled by 2 different valves separately
  - Piezoelectric ignition, pilot flame
  - Adjustable legs
    - Equal temperature distribution on the cooking surface
  - Fat collecting drawer
  - Easy to clean
  - Using over bench



GAST-6PIG60KYO

#### 80 LİK KROM GAZLI IZGARA / GAS CHROME GRILL PLATE /



- FR**
- Boitier en acier inoxydable
  - Nettoyage facile avec chauffage mobile
  - Modèles 80 cm contrôle cuisson séparable pour surface plate, demi lisse, demi rainuré
  - Cuisson surface plate réglable
  - Pieds réglable
  - Cuisson homogène surface plate
  - Canal de collecte de graisse-tiroir déchargeur
  - Nettoyage facile
  - Utilisable sur planche



GAST-6PIG80KYO

# 630 LUK SERİ / 630 SERIES / SÉRIE DES 630 ELEKTRİKLİ IZGARALAR / ELECTRIC GRILL PLATES / GRILL ELECTRIQUE

## 40 LİK ELEKTRİKLİ IZGARA / ELECTRIC GRILL PLATES / GRILL ELECTRIQUE



- TR**
- Paslanmaz çelik gövde
  - Pişirme yüzeyi düz, yarı oluklu ve oluklu olarak 3 model
  - 80'lik modellerde ayrı ayrı kontrol edilebilen pişirme yüzeyi -
  - Pişirme yüzeyi 50-300°C arası ayarlanabilir
  - Ayarlanabilir ayaklar
  - Homojen pişirme yüzeyi
  - Yağ toplama kanalı, boşaltma çekmecesi
  - Kolay temizlenebilir
  - Set üstü olarak kullanılır



GAST-6PIE40YO

## 60 LİK ELEKTRİKLİ IZGARA / ELECTRIC GRILL PLATES / GRILL ELECTRIQUE



- EN**
- Stainless steel body
  - Types of cooking plate (smooth, 1/2 nervour and nervour) - Cooking zone is controlled by 2 different valves separately
  - Thermostat adjustment from 50-300°C
  - Adjustable legs
  - Equal temperature distribution on the cooking surface
  - Fat collecting drawer
  - Easy to clean
  - Using over bench



GAST-6PIE60YO

## 80 LİK ELEKTRİKLİ IZGARA / ELECTRIC GRILL PLATES / GRILL ELECTRIQUE



- FR**
- Boîtier en acier inoxydable
  - Compatible au GPL et gaz naturel
  - Cuisson a 3 modèles (surface plate, rainuré demi rainuré)
  - Série 80 cm contrôle de cuisson séperable sur surface plate -
  - Pieds réglable
  - Cuisson homogène
  - Canal de collecte de graisse-tiroir déchargeur
  - Nettoyage facile
  - Utilisable sur planche



GAST-6PIE80YO



**630 LUK SERİ / 630 SERIES / SÉRIE DES 630 GRILL ELECTRIQUE CHORME**  
**ELEKTRİKLİ KROM IZGARALAR / ELECTRIC CHORME GRILL PLATES /**  
**GRILL ELECTRIQUE CHROME**

**40 LİK ELEKTRİKLİ KROM IZGARA / ELECTRIC CHROME GRILL PLATES /**   

- TR**
- Paslanmaz çelik gövde
  - Krom pişirme yüzeyi
  - Pişirme yüzeyi düz, yarı oluklu ve oluklu olarak 3 model
  - 80'lik modellerde ayrı ayrı kontrol edilebilen pişirme yüzeyi -
  - Pişirme yüzeyi 50-300°C arası ayarlanabilir
  - Ayarlanabilir ayaklar
  - Homojen pişirme yüzeyi
  - Yağ toplama kanalı, boşaltma çekmecesi
  - Kolay temizlenebilir
  - Set üstü olarak kullanılır



**GAST-6PIKE40YO**

**60 LİK ELEKTRİKLİ KROM IZGARA / ELECTRIC CHROME GRILL PLATES /**   

- EN**
- Stainless steel body
  - Chrome cooking surface
  - Types of cooking plate (smooth, 1/2 nervour and nervour) - Cooking zone is controlled by 2 different valves separately
  - Thermostat adjustment from 50-300°C
  - Adjustable legs
  - Equal temperature distribution on the cooking surface
  - Fat collecting drawer
  - Easy to clean
  - Using over bench



**GAST-6PIKE60YO**

**80 LİK ELEKTRİKLİ KROM IZGARA / ELECTRIC CHROME GRILL PLATES /**   

- FR**
- Boitier en acier inoxydable
  - Cuisson Chrome
  - Compatible au GPL et gaz naturel
  - Cuisson a 3 modèles (surface plate, rainuré demi rainuré)
  - Série 80 cm contrôle de cuisson séparable sur surface plate -
  - Pieds réglable
  - Cuisson homogène
  - Canal de collecte de graisse-tiroir déchargeur
  - Nettoyage facile
  - Utilisable sur planche



**GAST-6PIKE80YO**

**630 LUK SERİ / 630 SERIES / SÉRIE DES 630**  
**LAVATAŞ IZGARALAR / LAVASTONE GRILLS / GRILL A PIERRE DE LAVE**

**40 LİK LAVATAŞ IZGARA / LAVASTONE GRILL / GRILL A PIERRE DE LAVE**



- TR**
- Paslanmaz çelik gövde
  - Emniyet ventilli valf
  - Pilot alevi
  - LPG ve Doğalgaza uyumlu
  - Yağ toplama kanalı, boşaltma çekmecesini
  - Ayarlanabilir ayaklar
  - Kolay temizlenebilir
  - Set üstü olarak kullanılır

- EN**
- Stainless steel body
  - Safety gas valve with thermocouple
  - Pilot flame
  - Available LPG or Natural Gas
  - Fat collecting drawer
  - Adjustable legs
  - Easy to clean
  - Using over bench



**GAST-6LIG40**

**80 LİK LAVATAŞ IZGARA / LAVASTONE GRILL / GRILL A PIERRE DE LAVE**



- FR**
- Boitier en acier inoxydable
  - Thermo couple
  - Pilote d'alumage
  - Valable pour tube à gaz ou gaz naturel
  - Canal de collecte de graisse - Tiroir déchargeur
  - Fonte de type industriel
  - Pieds réglable
  - Nettoyage facile
  - Utilisable sur planche



**GAST-6LIG80**

## 630 LUK SERİ / 630 SERIES / SÉRIE DES 630 MAKARNA HAŞLAMA / PASTA COOKER / CUISEUR À PÂTE

### 40 LİK MAKARNA HAŞLAMA / PASTA COOKER / CUISEUR À PÂTE



- TR**
- Paslanmaz çelik gövde
  - Kolay temizlik
  - Hijyenik
  - Tahliye vanası
  - Yekpare havuz
  - 30-120°C ayarlı termostat
  - 8 litre kaynatma kapasitesi
  - Ayarlanabilir ayaklar
  - Uzun ömürlü
  - Set üstü olarak kullanılır.

- EN**
- Stainless steel body
  - Easy to clean
  - Hygienic
  - With drainage pipe
  - Monoblock bowl
  - 30-120°C Adjustable thermostat - 8 lt Boiling capacity
  - Adjustable legs
  - Long life
  - Using over bench



GAST-6MH40

- FR**
- Boitier en acier inoxydable
  - Nettoyage facile
  - Hygiénique
  - Vanne évacuatrice
  - Bac monobloc
  - Thermostat réglable 30°C - 120°C - Capacité de friture à 8l
  - Pied soutien réglable
  - Longue durée de vie
  - Utilisable sur planche

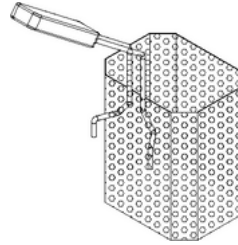

KOD CODE	EBATLAR DIMENSIONS	FIYA T
GAST-67.MKN.SPT.06	138 x 106 x 164	

### SOS BENMARİ / SAUCE BAIN-MARIE / SAUCE BAIN-MARIE



48 €

- TR**
- Paslanmaz çelik gövde
  - Gastronom küvetlere uygun hazne - Hijyenik
  - 30-120°C termostat kontrollü
  - Yekpare havuz
  - Ayarlanabilir ayaklar
  - Kolay temizlenebilir
  - Set üstü olarak kullanılır.
  - Tahliye vanası

- FR**
- Boitier en acier inoxydable
  - Cuvette gastronomique à réservoir - Hygiénique
  - Contrôle thermostat 30°C - 120°C
  - Bac massive
  - Pieds soutien réglable
  - Nettoyage facile
  - Utilisable sur planche

- EN**
- Stainless steel body
  - Reservoir available gastronom cups
  - Hygienic
  - Temperature adjustment from 30°C to 120°C
  - Monoblock bowl
  - Adjustable legs
  - Easy to Clean
  - Using over bench
  - Drainage pipe

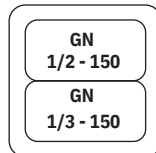

GAST-6SBM40



# 630 LUK SERİ / 630 SERIES / SÉRIE DES 630 PATATES DİNLENDİRME / HEATED CHIPS UNIT / REPOSE POMME DE TERRE

## PATATES DİNLENDİRME / HEATED CHIPS UNIT / REPOSE POMME DE TERRE



- TR**
- Paslanmaz çelik gövde
  - Ayarlanabilir ayaklar
  - Kolay temizlenebilir
  - Set üstü olarak kullanılır

- EN**
- Stainless steel body
  - Adjustable legs
  - Easy to clean
  - Using over bench

- FR**
- Boitier en acier inoxydable
  - Pieds réglable
  - Nettoyage facile
  - Utilisation sur planche



GAST-6PDE40

KOD CODE	MODEL DESCRIPTION	EBATLAR DIMENSIONS	K G KG	GÜÇ POWER	ENERJİ ENERGY	FİYAT PRICE
GAST-6PDE40	Patates Dinlendirme Heated Chips Unit	400 x 630 x 300	16 Kg.	0,75 kW	230 V ~ 50 Hz	540 €

## NÖTR TEZGAHLAR / WORKING BENCHS / COMPTOIR NEUTRES



GAST-6NT40



GAST-6NT80

**630 LUK SERİ / 630SÉRIE DES  
SERIES / DOLAPLAR /630  
CUPBOARDS / ARMOIRES**

**40 LİK DOLAP / CUPBOARD / ARMOIRE**

- TR**
- Paslanmaz çelik gövde
  - Uzun ömürlü
  - Çarpma kapılı
  - 63'lük seri bütün cihazlara uyumlu - Ayarlanabilir ayaklar



**GAST-6DP40**

**60 LİK DOLAP / CUPBOARD / ARMOIRE**

- EN**
- Stainless steel body
  - Long life
  - With slam door
  - 63 series compatible with all devices - Adjustable feet



**GAST-6DP60**

**80 LİK DOLAP / CUPBOARD / ARMOIRE**

- FR**
- Corps en acier inoxydable
  - Longue durée de vie
  - Avec porte à clapet
  - Série 63 compatible avec tous les appareils - Pieds réglables



**GAST-6DP80**

**630 LUK SERİ / 630 SERIES / SÉRIE DES 630**  
**GAZLI KUZİNE / GAS RANGE / CUISINIÈRE A GAZ**

**TR**

- Paslanmaz çelik gövde
- Emniyet ventilli valf
- Alev denetleme tertibatı
- LPG ve Doğalgaza uyumlu
- Yekpare üst tablalı
- Piezoelektrik ateşlemeli, pilotlu fırın
- Termostat kontrollü fırın 100-300°C arası ayarlanabilir - Fırın ölçüleri 30x45 tepsiye göre
- İzolasyonlu fırın
- Tel raf (1 adet)
- Ayarlanabilir ayaklar

**EN**

- Stainless steel body
- Safety gas valve with thermocouple
- Fire inspect system
- Heavy duty top cast iron
- Available LPG or Natural Gas
- Easy to clean
- Piezoelectric ignition and pilot flame
- Oven thermostat adjustment between 100°C to 300°C - Oven size is 30x45
- Isolated oven
- Removable wire tray size GN 1/1
- Adjustable legs

**FR**

- Boîtier en acier inoxydable
- Thermo couple
- Dispositif du contrôle feu
- Compatible avec GPL / gaz naturel
- Plancher brûleur mono bloc
- Pilote d'allumage Pié-électrique
- Contrôle thermostat du four (100°C- 300°C)
- Dimension du four-plateau four (30 45) - Four isolé
- Grille 1 pièce
- Pieds réglable



**GAST-6KZG60**

**700**  
**SERİ**  
SERIES

**LÜK**  
700  
/ Série des 700







**700 LÜK SERİ**  
**700 SERIES**  
**Série des 700**

# 700 LÜK SERİ / 700 SERIES / SÉRIE DES 700 ELEKTRİKLİ FRİTÖZLER / ELECTRIC FRYERS / FRITEUSES ELECTRIQUE

## 40 LİK TEKLİ ELEKTRİKLİ FRİTÖZ / ELECTRIC FRYER WITH BASKET ELECTRIC

- TR - Paslanmaz çelik gövde
- Hareketli ısıtıcılar sayesinde kolay temizlik - Hijyenik
- Tahliye vanası
- Yekpare bankolu havuz
- Emniyet termostatı
- 100-180°C ayarlı termostat
- 12 lt kızartma kapasiteli
- Ayarlanabilir ayaklar
- Uzun ömürlü
- Set üstü ve dolaplı kullanıma uygundur



GAST-7FE40

- EN - Stainless steel body
- Easy to clean
- Hygienic
- With drainage pipe
- Monoblock bowl
- Safety thermostat
- 100-180°C Adjustable thermostat
- 12 lt frying capacity
- Adjustable legs
- Long life
- Available use over bench or with cupboard

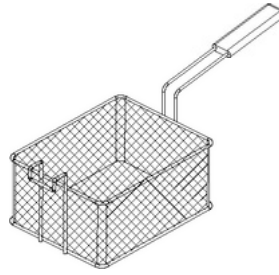

## 80 LİK ÇİFTLİ ELEKTRİKLİ FRİTÖZ / ELECTRIC FRYER WITH 2 BASKETS ELECTRIC

- FR - Boîtier en acier inoxydable
- Nettoyage facile avec chauffage mobile
- Hygiénique
- Soupape d'évacuation
- Bac monobloc
- Thermostat de sécurité
- Thermostat réglable (100°C- 180°C)
- Capacité friture a 12l
- Pieds réglable
- Longévité
- Utilisable sur planche ou armoire



GAST-7FE80

## 700 LÜK SERİ / 700 SERIES / SÉRIE DES 700

## ELEKTRİKLİ DİJİTAL FRİTÖZLER / ELECTRIC DIGITAL FRYERS /

FRITEUSES ELECTRIQUE  
DIGITAL

TR

- Paslanmaz çelik gövde
- Hareketli ısıtıcılar sayesinde kolay temizlik - Hijyenik
- Tahliye vanası
- Yekpare bankolu havuz
- Emniyet termostadı
- 100-180°C ayarlı dijital termostat
- 12 lt kızartma kapasiteli
- Ayarlanabilir ayaklar
- Uzun ömürlü
- Set üstü ve dolaplı kullanıma uygundur



GAST-7FED40

EN

- Stainless steel body
- Easy to clean
- Hygienic
- With drainage pipe
- Monoblock bowl
- Safety thermostat
- 100-180°C Adjustable digital thermostat
- 12 lt frying capacity
- Adjustable legs
- Long life
- Available use over bench or with cupboard

## 80 LİK TEKLİ ELEKTRİKLİ DİJİTAL FRİTÖZ / ELECTRIC DIGITAL FRYER WITH 2 BASKETS /



FR

- Boîtier en acier inoxydable
- Nettoyage facile avec chauffage mobile
- Hygiénique
- Soupape d'évacuation
- Bac monobloc
- Thermostat de sécurité
- Thermostat réglable digital (100c-180c) - Capacité friture a 12l
- Pieds réglable
- Longévité
- Utilisable sur planche ou armoire



GAST-7FED80

**700 LÜK SERİ / 700 SERIES / SÉRIE DES 700**  
**GAZLI FRİTÖZLER / GAS FRYERS / FRITEUSES A GAZ**

**40 LİK GAZLI FRİTÖZ / GAS FRYER WITH 1 BASKET / FRITEUSE A GAZ**



- TR**
- Paslanmaz çelik gövde
  - Piezoelektrik ateşlemeli pilot
  - LPG ve Doğalgaza uyumlu
  - Yekpare bankolu havuz
  - Emniyet termostadı
  - 100°C-180°C ısı kontrolü
  - 15 lt yağ kapasitesi
  - Ayarlanabilir ayak

- EN**
- Stainless steel body
  - Safety gas thermostat 100°C-180°C
  - Piezoelectric ignition and pilot flame - Available LPG or Natural Gas
  - Monoblock bowl
  - 15 lt frying capacity
  - Adjustable legs



**GAST-7FG40**

**80 LİK GAZLI FRİTÖZ / GAS FRYER WITH 2 BASKETS / FRITEUSE A GAZ**



- FR**
- Adaptable à fonctionner au GPL ou GN.
  - Commande thermostatique.
  - Panier en acier inoxydable.
  - Robinet de sécurité magnétique.
  - Vanne de vidange d'huile
  - Sécurité du thermostat contre la surchauffe.
  - Nettoyage facile grâce à la conception hygiénique.
  - Corps en acier inoxydable

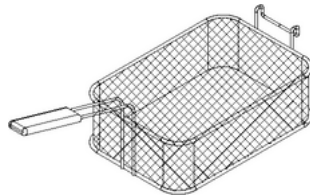

**GAST-7FG80**



# 700 LÜK SERİ / 700 SERIES / SÉRIE DES 700 MAKARNA HAŞLAMA / PASTA COOKER / CUISEUR A PATE

40 LİK ELEKTRİKLİ MAKARNA HAŞLAMA / ELECTRIC PASTA COOKER /

CUISEUR À PATE ELECTRIQUE



- TR**
- Paslanmaz çelik gövde
  - Kolay temizlenebilir
  - Hijyenik
  - Tahliye vanası
  - Yekpare havuz
  - 30-120°C ayarlı termostat
  - 12 lt kaynatma kapasitesi
  - Ayarlanabilir ayaklar
  - Uzun ömürlü
  - Setüstü ve dolaplı kullanıma uygundur

- Stainless steel body
- Easy to clean
- Hygienic
- Drainage pipe
- Monoblock bowl
- 30°C-180°C Adjustable thermostat
- 12 lt boiling capacity
- Adjustable legs
- Long life
- Available use over bench or with cupboard



GAST-7MH40

- FR**
- Boitier en acier inoxydable
  - Nettoyage facile
  - Hygiénique
  - Soupape d'évacuation
  - Bac monobloc
  - Thermostat réglable 30°C-120°C
  - Capacité de friture 12 lt
  - Pieds réglable
  - Longévité
  - Utilisable sur planche ou armoire

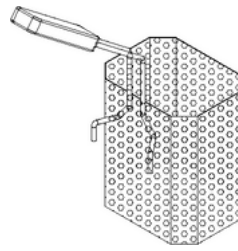

40 LİK GAZLI MAKARNA HAŞLAMA / GAS PASTA COOKER / CUISEUR À PATE ELECTRIQUE



- TR**
- Paslanmaz çelik gövde
  - Piezoelektrik ateşlemeli pilot
  - LPG ve Doğalgaza uyumlu
  - Alev denetleme tertibatı pilot yanış sistemi
  - Kolay temizlenebilir
  - Hijyenik
  - Tahliye vanası
  - Yekpare havuz
  - 26 lt kaynatma kapasitesi
  - Ayarlanabilir ayaklar
  - Uzun ömürlü

- Stainless steel body
- Piezoelectric ignition and pilot flame
- Fire inspect system
- Easy to clean
- Hygienic
- Drainage pipe
- Monoblock bowl
- 26 lt boiling capacity
- Adjustable legs
- Long life



GAST-7MHG40

- FR**
- Boitier en acier inoxydable
  - Commande thermostatique.
  - Panier en acier inoxydable.
  - Dispositif de surveillance de flamme
  - Nettoyage facile
  - Hygiénique
  - Soupape d'évacuation
  - Bac monobloc
  - Capacité de friture 26 lt
  - Pieds réglable
  - Longévité

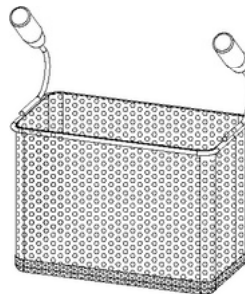

# 700 LÜK SERİ / 700 SERIES / SÉRIE DES 700 ELEKTRİKLİ OCAKLAR / ELECTRIC COOKERS / CUISINIÈRE ELECTRIQUE

## 2 Lİ ELEKTRİKLİ OCAK / ELECTRIC COOKER WITH 2 HOT PLATES /



- TR - Paslanmaz çelik gövde
- Pik dökümlü 20-23 cm pleytler
- 3 kademeli kontrol edilebilir
- Ayarlanabilir ayaklar
- Kolay temizlenebilir
- Set üstü ve dolaplı kullanıma uygun

CUISINIÈRE ELECTRIQUE A 2 PLQUES  
CHAUFFANTES



GAST-70CE40

## 4 LÜ ELEKTRİKLİ OCAK / ELECTRIC COOKER WITH 4 HOT PLATES /



- EN - Stainless steel body
- 20-23 cm diameter of heaters
- Adjustable control system
- Adjustable legs
- Easy to clean
- Available use over bench or with cupboard

CUISINIÈRE ELECTRIQUE A 4 PLAQUES CHAUFFANTES

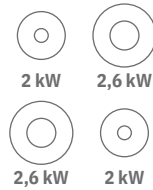

GAST-70CE80

## 6 LI ELEKTRİKLİ OCAK / ELECTRIC COOKER WITH 6 HOT PLATES /



- FR - Boitier en acier inoxydable
- Les plates de fonte à 20 cm
- Contrôle à 3 niveaux graduels - Pieds soutien réglable
- Nettoyage facile
- Utilisable sur planche

CUISINIÈRE ELECTRIQUE A 6 PLAQUES  
CHAUFFANTES



GAST-70CE120

**700 LÜK SERİ / 700 SERIES / SÉRIE DES 700**  
**GAZLI OCAKLAR / GAS COOKERS / CUISINIÈRE A GAZ**

**2 Lİ GAZLI OCAK / GAS COOKER WITH 2 BURNERS / CUISINIÈRE GAZ A 2 BRÔLEURS**

- TR**
- Paslanmaz çelik gövde
  - Emniyet ventilli valf
  - Alev denetleme tertibatı pilot yanış sistemi - Sanayi tipi döküm
  - LPG ve Doğalgaza uyumlu
  - Ayarlanabilir ayaklar
  - Kolay temizlenebilir
  - Set üstü ve dolaplı kullanıma uygundur



**GAST-70CG240**

**4 LÜ GAZLI OCAK / GAS COOKER WITH 4 BURNERS / CUISINIÈRE GAZ A 4 BRÔLEURS**

- EN**
- Stainless steel body
  - Safety gas valve with thermocouple
  - Fire inspect system
  - Heavy duty top cast iron
  - Available LPG or Natural Gas
  - Adjustable legs
  - Easy to clean
  - Available use over bench or with cupboard



**GAST-70CG480**

**6 LI GAZLI OCAK / GAS COOKER WITH 6 BURNERS / CUISINIÈRE GAZ A 6 BRÔLEURS**

- FR**
- Boitier en acier inoxydable
  - Thermocouple
  - Dispositif de surveillance de flamme - Fonte de type industriel
  - Compatible au GPL / gaz naturel
  - Nettoyage facile
  - Utilisable sur planche ou armoire



**GAST-70CG6120**

## 700 LÜK SERİ / 700 SERIES / SÉRIE DES 700 GRILL ELECTRIQUE ELEKTRİKLİ IZGARALAR / ELECTRIC GRILL PLATES /

### 40 LİK ELEKTRİKLİ IZGARA / ELECTRIC GRILL PLATE /



- TR**
- Paslanmaz çelik gövde
  - Pişirme yüzeyi düz, yarı yollu ve tam yollu olarak 3 model - Pişirme yüzeyi 50-300°C arası ayarlanabilir
  - Ayarlanabilir ayaklar
  - Homojen pişirme yüzeyi
  - Yağ toplama kanalı, boşaltma çekmecesini
  - Kolay temizlenebilir
  - Set üstü olarak kullanılır



GAST-7PIE40YO

- EN**
- Stainless steel body
  - Types of cooking plate (smooth, 1/2 nervour and nervour) - Thermostat adjustment between 50-300°C
  - Adjustable legs
  - Equal temperature distribution on the cooking surface
  - Fat collecting drawer
  - Easy to clean
  - Using over bench

### 80 LİK ELEKTRİKLİ IZGARA / ELECTRIC GRILL PLATE /



- FR**
- Boîtier en acier inoxydable
  - 3 Modèles de cuisson, surface lisse, demi rainuré ou rainuré - Surface de cuisson réglable (50°C-300°C)
  - Pieds réglable
  - Surface de cuisson homogène
  - Canal de collecte de graisse-Tiroir décharge
  - Nettoyage facile
  - Utilisable sur planche ou armoire



GAST-7PIE80YO



## 700 LÜK SERİ / 700 SERIES / SÉRIE DES 700 ELEKTRİKLİ KROM IZGARALAR / ELECTRIC CHROME GRILL PLATES /

### 40 LİK ELEKTRİKLİ KROM IZGARA / ELECTRIC CHROME GRILL PLATES /

- TR**
- Paslanmaz çelik gövde
  - Pişirme yüzeyi düz, yarı oluklu ve tam oluklu olarak 3 model - Krom pişirme yüzeyi
  - Pişirme yüzeyi 50-300°C arası ayarlanabilir
  - Ayarlanabilir ayaklar
  - Homojen pişirme yüzeyi
  - Yağ toplama kanalı, boşaltma çekmecesini
  - Kolay temizlenebilir
  - Set üstü olarak kullanılır



GAST-7PIKE40YO

- EN**
- Stainless steel body
  - Types of cooking plate (smooth, 1/2 nervour and nervour) - Chrome cooking surface
  - Thermostat adjustment between 50-300°C
  - Adjustable legs
  - Equal temperature distribution on the cooking surface
  - Fat collecting drawer
  - Easy to clean
  - Using over bench

### 80 LİK ELEKTRİKLİ KROM IZGARA / ELECTRIC CHROME GRILL PLATES /

- FR**
- Boîtier en acier inoxydable
  - 3 Modèles de cuisson, surface lisse, demi rainuré ou rainuré - Cuisson chrome
  - Surface de cuisson réglable (50°C-300°C)
  - Pieds réglable
  - Surface de cuisson homogène
  - Canal de collecte de graisse-Tiroir décharge
  - Nettoyage facile
  - Utilisable sur planche ou armoire



GAST-7PIKE80YO

## 700 LÜK SERİ / 700 SERIES / SÉRIE DES 700 GAZLI IZGARALAR / GAS GRILL PLATES / GRILL A GAZ

### 40 LİK GAZLI IZGARA / GAS GRILL PLATE / GRILL A GAZ



- TR - Paslanmaz çelik gövde
- LPG ve Doğalgaza uyumlu
- Pişirme yüzeyi düz, yarı oluklu ve tam oluklu olarak 3 model
- 80'lik modellerde ayrı ayrı kontrol edilebilen pişirme yüzeyi
- Piezoelektrik ateşlemeli, pilotlu
- Ayarlanabilir ayaklar
- Homojen pişirme yüzeyi
- Yağ toplama kanalı, boşaltma çekmecesini
- Kolay temizlenebilir
- Setüstü ve dolaplı kullanıma uygundur.



GAST-7PIG40YO

- EN - Stainless steel body
- Available LPG or Natural Gas
- Types of cooking plate (smooth, 1/2 nervour and nervour)
- 80 cm models have double indepented cooking zone by two gas valves
- Piezoelectric ignition, pilot flame
- Adjustable legs
- Equal temperature distribution on the cooking surface
- With removable fat collecting drawer
- Easy to clean
- Available use over bench or with cupboard

### 80 LİK GAZLI IZGARA / GAS GRILL PLATE / GRILL A GAZ



- FR - Boitier en acier inoxydable
- 3 Modèles de cuisson, surface lisse, demi rainuré ou rainuré - Contrôle de cuisson séperable sur surface plate / modèle 80 - Surface de cuisson réglable
- Pieds réglable
- Surface de cuisson homogène
- Canal de collecte de graisse-Tiroir décharge
- Nettoyage facile
- Utilisable sur planche ou armoire



GAST-7PIG80YO

40 LİK GAZLI KROM IZGARA / GAS CHROME GRILL PLATE /



GRILL A GAZ CHROME

TR

- Paslanmaz çelik gövde
- LPG ve Doğalgaza uyumlu
- Krom pişirme yüzeyi
- Pişirme yüzeyi düz, yarı oluklu ve tam oluklu olarak 3 model - 80'lik modellerde ayrı ayrı kontrol edilebilen pişirme yüzeyi
- Piezoelektrik ateşlemeli, pilotlu
- Ayarlanabilir ayaklar
- Homojen pişirme yüzeyi
- Yağ toplama kanalı, boşaltma çekmecesini
- Kolay temizlenebilir
- Setüstü ve dolaplı kullanıma uygundur.



GAST-7PIG40KYO

EN

- Stainless steel body
- Available LPG or Natural Gas
- Chrome cooking surface
- Types of cooking plate (smooth, 1/2 nervour and nervour)
- 80 cm models have double indepented cooking zone by two gas valves
- Piezoelectric ignition, pilot flame
- Adjustable legs
- Equal temperature distribution on the cooking surface
- With removable fat collecting drawer
- Easy to clean
- Available use over bench or with cupboard

80 LİK GAZLI KROM IZGARA / GAS CHROME GRILL PLATE /



GRILL A GAZ CHROME

FR

- Boîtier en acier inoxydable
- 3 Modèles de cuisson, surface lisse, demi rainuré ou rainuré - Cuisson chrome
- Contrôle de cuisson séperable sur surface plate / modèle
- 80 - Surface de cuisson réglable
- Pieds réglable
- Surface de cuisson homogène
- Canal de collecte de graisse–Tiroir décharge
- Nettoyage facile
- Utilisable sur planche ou armoire



GAST-7PIG80KYO

**700 LÜK SERİ / 700 SERIES / SÉRIE DES 700**  
**LAVATAŞ IZGARALAR / LAVASTONE GRILLS / GRILL A PIERRE DE LAVE**

**40 LİK LAVATAŞ IZGARA / LAVASTONE GRILL**



- TR**
- Paslanmaz çelik gövde
  - Emniyet ventilli valf
  - Pilot alevi
  - LPG ve Doğalgaza uyumlu
  - Yağ toplama kanalı, boşaltma çekmecesi
  - Ayarlanabilir ayaklar
  - Kolay temizlenebilir
  - Set üstü olarak kullanılır



**GAST-7LIG40**

- EN**
- Stainless steel body
  - Safety gas valve with thermocouple
  - Pilot flame
  - Available LPG or Natural Gas
  - Fat collecting drawer
  - Adjustable legs
  - Easy to clean
  - Using over bench

**80 LİK LAVATAŞ IZGARA / LAVASTONE GRILL /**



- FR**
- Boitier en acier inoxydable
  - Thermo couple
  - Pilot d'allumage
  - Compatible au GPL et gaz naturel
  - Canal de collecte de graisse–Tiroir décharge
  - Pieds réglable
  - Nettoyage facile
  - Utilisable sur planche ou armoire



**GAST-7LIG80**



**700 LÜK SERİ / 700 SERIES / SÉRIE DES 700**  
**DÖKÜM IZGARALAR / CAST IRON GRILL / GRILL EN FONTE**

**40 LİK DÖKÜM IZGARA / CAST IRON GRILL / GRILL EN FONTE**



- TR**
- Paslanmaz çelik gövde
  - Emniyet ventilli valf
  - Pilot alevi
  - LPG ve Doğalgaza uyumlu
  - Su haznesi ile ürünü nemlendirme özelliği -  
Döküm pişirme yüzeyi
  - Ayarlanabilir ayaklar
  - Kolay temizlenebilir
  - Setüstü ve dolaplı kullanıma uygundur



**GAST-7DIG40**

**80 LİK DÖKÜM IZGARA / CAST IRON GRILL / GRILL EN FONTE**



- EN**
- Stainless steel body
  - Safety gas valve with thermocouple
  - Pilot flame
  - Available LPG or Natural Gas
  - Water drawers
  - Cast iron surface
  - Fat collecting drawer
  - Adjustable legs
  - Easy to clean
  - Available use over bench or with cupboard



**GAST-7DIG80**

**120 LİK DÖKÜM IZGARA / CAST IRON GRILL / GRILL EN FONTE**



- FR**
- Boitier en acier inoxydable
  - Thermo couple
  - Pilote d'alumage
  - Compatible au GPL et Gas Naturel
  - Réservoir d'eau humidifié le produit - Indicateur du niveau d'eau
  - Surface de cuisson en fer
  - Pieds réglable
  - Nettoyage facile
  - Utilisable sur planche ou armoire



**GAST-7DIG120**

## 700 LÜK SERİ / 700 SERIES / SÉRIE DES 700 ÇUBUKLU IZGARALAR / PIPE GRILLS / GRILL A BARRE

### 50 LİK ÇUBUKLU IZGARA / PIPE GRILL / GRILL A BARRE



- Paslanmaz çelik gövde
- Özel dizayn edilmiş ısıtıcılar
- Hareketli ısıtıcılar sayesinde kolay temizlik
- Sıcak su haznesi
- Ürünü kurutmadan pişirme özelliği
- Özel ısı ayarlı termostatik sistem
- Tahliye vanası
- Ayarlanabilir ayaklar
- Setüstü ve dolaplı kullanıma uygundur.



GAST-7CIG50

### 80 LİK ÇUBUKLU IZGARA / PIPE GRILL / GRILL A BARRE



- Stainless steel body
- Special heating system
- Moving heat system provides easy cleaning
- Steam function
- Temperature adjust with termostatic special system
- Drainage pipe
- Adjustable legs
- Available use over bench or with cupboard



GAST-7CIG80

### 120 LİK ÇUBUKLU IZGARA / PIPE GRILL / GRILL A BARRE



- Boîtier en acier inoxydable
- Chauffage spécialement conçu
- Nettoyage facile grâce au chauffage mobile
- Réservoir d'eau chaude
- Caractéristique de cuisson sans sécher le produit
- Système spécial réglage thermostatique de la chaleur
- Soupape d'évacuation
- Pieds réglable
- Utilisable sur planche ou armoire



GAST-7CIG120

40 LİK DOLAP / CUPBOARD / ARMOIRE

- TR
- Paslanmaz çelik gövde
  - Uzun ömürlü
  - Çarpma kapılı
  - 70'lik seri bütün cihazlara uyumlu - Ayarlanabilir ayaklar



GAST-7DP40

80 LİK DOLAP / CUPBOARD / ARMOIRE

- EN
- Stainless steel body
  - Long life
  - Available 70 series products
  - Adjustable legs



GAST-7DP80

120 LİK DOLAP / CUPBOARD / ARMOIRE

- FR
- Boîtier en acier inoxydable
  - Longévité
  - Portes battantes
  - Série 70 est compatible à tous les appareils - Pieds réglable



GAST-7DP120

**700 LÜK SERİ / 700 SERIES / SÉRIE DES 700**  
**PATATES DİNLENDİRME / HEATED CHIPS UNIT / REPOSE POMME DE TERRE**

**PATATES DİNLENDİRME / HEATED CHIPS UNIT /**



- TR** - Paslanmaz çelik gövde  
Ayarlanabilir ayaklar  
- Kolay temizlenebilir  
- Setüstü ve dolaplı kullanıma uygundur.

- Boîtier en acier inoxydable  
- Pieds réglables  
- Nettoyage facile  
- Utilisation sur planche ou armoire



**GAST-7PDE40**

- EN** - Stainless steel body  
- Adjustable legs  
- Easy to clean  
- Available use over bench or with cupboard

KOD CODE	MODEL DESCRIPTION	EBATLAR DIMENSIONS	LİTR LITRE	K G KG	GÜÇ POWER	ENERJİ ENERGY	FİYAT PRICE
GAST-7PDE40	Patates Dinlendirme Heated Chips Unit	400 x 700 x 300	-	17 Kg.	0,75 kW	230 V ~ 50 Hz	

570 €

**40 LİK NÖTR TEZGAH / WORKING BENCH /**



**GAST-7NT40**

**80 LİK NÖTR TEZGAH / WORKING BENCH /**



**GAST-7NT80**



**700 LÜK SERİ / 700 SERIES / SÉRIE DES 700**  
**BENMARİLER / BAIN-MARIES / CAISSEUR SAUCE BAIN-MARIE**

**40 LİK BENMARİ / BAIN-MARIE / CAISSEUR SAUCE BAIN-MARIE**



- TR**
- Paslanmaz çelik gövde
  - Gastronom küvetlere uygun hazne
  - Hijyenik
  - Tahliye vanası
  - 30-120°C termostat kontrollü
  - Yekpare havuz
  - Ayarlanabilir ayaklar
  - Kolay temizlenebilir
  - Setüstü ve dolaplı kullanıma uygundur.



**GAST-7BM40**

- EN**
- Stainless steel body
  - Hygienic
  - One piece reservoir
  - Temperature adjustment from 30°C to 120°C - Monoblock bowl
  - Adjustable legs
  - Easy to clean
  - Available use over bench or with cupboard

**80 LİK BENMARİ / BAIN-MARIE / CAISSEUR SAUCE BAIN-MARIE**



- FR**
- Boîtier en acier inoxydable
  - Hygiénique
  - Soupape d'évacuation
  - Thermostat contrôleur cuisson (30°C-120°C) - Bac monobloc
  - Pieds réglables
  - Nettoyage facile
  - Utilisable sur planche ou armoire



**GAST-7BM80**

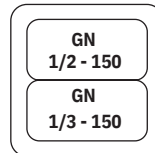

**700 LÜK SERİ / 700 SERIES / SÉRIE DES 700**  
**ELEKTRİKLİ KUZİNE / ELECTRIC RANGE / CUISINIÈRE ELECTRIQUE**

**4 LÜ ELEKTRİKLİ KUZİNE / ELECTRIC RANGE WITH 4 HOT PLATES /**



- TR**
- Paslanmaz çelik gövde
  - Pik dökümlü 23 cm pleytler
  - 3 kademeli kontrol edilebilir
  - Fırın ölçüleri GN 1/1 göre
  - Fırın sıcaklığı 50°C-300°C arası ayarlanabilir - Fırın içi rezistanslar alt ve üst olarak ayrı ayrı kontrol edilir
  - İzolasyonlu fırın
  - Seyyar GN 1/1 tel raf
  - Ayarlanabilir ayaklar

- EN**
- Stainless steel body
  - 23 cm diameter heaters
  - Adjustable control system
  - Oven size is GN 1/1
  - Oven thermostat adjustment between 50°C to 300°C
  - Oven heaters work separately or together - Isolated oven
  - Removable wire tray size GN 1/1
  - Adjustable legs

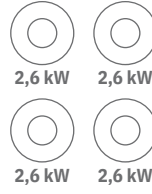

**GAST-7K Z80**

**6 LI ELEKTRİKLİ KUZİNE / ELECTRIC RANGE WITH 6 HOT PLATES /**



- FR**
- Boîtier en acier inoxydable
  - Plate de fonte de 23 cm
  - Réglable à 3 niveaux
  - Mesures du four d'après GN 1/1
  - Température du four réglable (50°C-300°C)
  - Résistance du four contrôlable pour cuisson séparable haut et bas
  - Four isolé
  - Grille mobile GN 1/1
  - Pieds réglable



**GAST-7KZ120**

**700 LÜK SERİ / 700 SERIES / SÉRIE DES 700**  
**GAZLI KUZİNELER / GAS RANGES / CUISINIÈRES A GAZ**

**4 LÜ GAZLI KUZİNE / GAS RANGE 4 WITH BURNERS / CUISINIÈRE A GAZ**



**TR**

- Paslanmaz çelik gövde
- Emniyet ventilli valf
- Alev denetleme tertibatı
- Sanayi tipi döküm
- LPG ve Doğalgaza uyumlu
- Kolay temizlenebilir pislik tepsisi
- Piezoelektrik ateşlemeli, pilotlu
- Termostat kontrollü fırın 100-300°C arası ayarlanabilir - Fırın ölçüleri GN 2/1 göre
- İzolasyonlu fırın
- Seyyar GN 2/1 tel raf
- Ayarlanabilir ayaklar



**GAST-7KZG470**

**EN**

- Stainless steel body
- Safety gas valve with thermocouple
- Fire inspect system
- Heavy duty top cast iron
- Available LPG or Natural Gas
- Easy to clean
- Piezoelectric ignition and pilot flame
- Oven thermostat adjustment between 100°C to 300°C - Oven size is GN 2/1
- Isolated oven
- Removable wire tray size GN 2/1
- Adjustable legs

**6 LI GAZLI KUZİNE / GAS RANGE 6 WITH BURNERS / CUISINIÈRE A GAZ**



**FR**

- Boîtier en acier inoxydable
- Thermo couple
- Dispositif du contrôle de feu
- Fonte de type industriel
- Compatible au GPL- Gaz Naturel
- Nettoyage facile de la saleté du plateau
- Pilote d'allumage piézo-électrique
- Thermostat contrôle cuisson (100°C-300°C) - Dimension du four selon GN 2/1
- Four isolé
- Grille mobile GN 2/1
- Pieds réglable



**GAST-7KZG670**

**KAYNATMA KAZANI (ENDİREKT ISITMA) / BOILING PAN (INDIRECT HEATING) /  
MARMITE (INDIRECT)**

TR

- Paslanmaz çelik gövde
- Karşı ağırlıklı kapak
- Brülör komple magnet ventili
- Magnet mentil ateşleme ve stop butonları ile pilotlu termokulplu ve termostatlı
- Alev sönünce gaz kesme
- Soğuk-sıcak su doldurma musluğu
- Boşaltma musluğu

EN

- Stainless steel body
- Counterweighted folding lid
- Burner with complete magnet security valve
- Which contains ignition and stop button together with pilot thermocouple
- Cold and hot water filling cock
- Drainage cock

FR

- Contrôle de la valve sous-préssion avec le manomètre. - Robinet de remplissage d'eau chaude et froide.
- Robinet de drainage.
- Clapet de surcharge.
- Bac avec double casseroles.
- Nettoyage facile grâce à la conception hygiénique.
- Corps en acier inoxydable.



**GAST-7KT80**



## 700 LÜK SERİ / 700 SERIES / SÉRIE DES 700 DEVRİLİR TAVALAR / TILTING BRATT PANS / BASCUL ANTE

TR

- Gövde, panel, tava paslanmaz çelik
- Kaldırma mekanizması el ile çalışır
- Paslanmaz çelik brülör ateşlemeli, pilotlu termokuplu ve termostatlı
- Alev sönerse gaz kesilir
- LPG ve Doğalgaza uyumludur
- Cihaz üstündeki musluk ile doldurma ve yıkama yapmak kolaydır

EN

- Body, panelling and pan made of stainless steel
- The tilting mechanism is manuel operated
- Stainless steel burner with ignition, pilot thermocouple and thermostat
- If the flame goes out, gas are cutted off
- Operable with LPG and Natural Gas
- Filling with faucet on top of device and washing is easy

FR

- Système de levage manuel.
- Clapet de surcharge.
- Interrupteur de sécurité.
- Nettoyage facile grâce à la conception hygiénique. - Construction en acier inoxydable.



GAST-7DTG80

# 700 LÜK SERİ / 700 SERIES / SÉRIE DES 700 CUISINIÈRE ELECTRIQUE A CARRÉ PLAQUE CHAUFFANTES KARE PLEYT ELEKTRİKLİ OCAKLAR / ELECTRIC COOKERS WITH SQUARE HOT PLATE /

## 2 Lİ KARE ELEKTRİKLİ OCAK / ELECTRIC COOKER WITH 2 SQUARE HOT PLATES /



- TR**
- Paslanmaz çelik gövde
  - Pik dökümlü 22x22 cm pleytler
  - 6 kademeli kontrol edilebilir
  - Ayarlanabilir ayaklar
  - Kolay temizlenebilir
  - Set üstü ve dolaplı kullanıma uygun



GAST-70CE240

## 4 LÜ KARE ELEKTRİKLİ OCAK / ELECTRIC COOKER WITH 4 SQUARE HOT PLATES /



- EN**
- Stainless steel body
  - 22x22 cm diameter of heaters
  - Adjustable control system
  - Adjustable legs
  - Easy to clean
  - Available use over bench or with cupboard

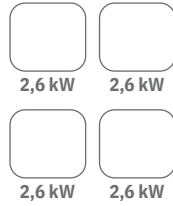

GAST-70CE480

## 6 LI KARE ELEKTRİKLİ OCAK / ELECTRIC COOKER WITH 6 SQUARE HOT PLATES /



- FR**
- Boitier en acier inoxydable
  - Les plates de fonte à 22 cm
  - Contrôle à 6 niveaux graduels
  - Pieds soutien réglable
  - Nettoyage facile
  - Utilisable sur planche



GAST-70CE6120

- Paslanmaz çelik gövde
- Pik dökümlü 22x22 cm pleytler
- 6 kademeli kontrol edilebilir
- Fırın ölçüleri GN 1/1 göre
- Fırın sıcaklığı 50°C-300°C arası ayarlanabilir - Fırın içi rezistanslar alt ve üst olarak ayrı ayrı kontrol edilir
- İzolasyonlu fırın
- Seyyar GN 1/1 tel raf
- Ayarlanabilir ayaklar

EN

- Stainless steel body
- 22x22 cm diameter heaters
- Adjustable control system
- Oven size is GN 1/1
- Oven thermostat adjustment between 50°C to 300°C
- Oven heaters work separately or together - Isolated oven
- Removable wire tray size GN 1/1
- Adjustable legs

FR

- Boîtier en acier inoxydable
- Plate de fonte de 22 cm
- Réglable à 6 niveaux
- Mesures du four d'après GN 1/1
- Température du four réglable (50°C-300°C)
- Résistance du four contrôlable pour cuisson séparable haut et bas
- Four isolé
- Grille mobile GN 1/1
- Pieds réglable



GAST-7KZ480

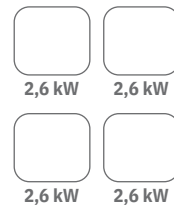

GAST-7KZ670

## 700 LÜK SERİ / 700 SERIES / SÉRIE DES 700 CUISINIÈRE ELECTRIQUE A FONTE KAPALI ATEŞ ELEKTİRİKLİ KUZİNE-OCAK / SOLID TOP ELECTRIC /

- Paslanmaz çelik gövde
- Pişirme yüzeyi 15mm ST52 Pleyt
- 4 bölge kontrol edilebilen pişirme yüzeyi
- Fırın ölçüleri GN 1/1 göre
- Fırın sıcaklığı 50°C-300°C arası ayarlanabilir
- Fırın içi rezistanslar alt ve üst olarak ayrı ayrı kontrol edilir
- İzolasyonlu fırın
- Seyyar GN 1/1 tel raf
- Ayarlanabilir ayaklar

- EN**
- Stainless steel body
  - Type of cooking plate 15mm ST52
  - Cooking surface able to control by 4 independent zones
  - Oven size is GN 1/1
  - Oven thermostat adjustment between 50°C to 300°C
  - Oven heaters work seperately or together
  - Isolated oven
  - Removable wire tray size GN 1/1
  - Adjustable legs

- FR**
- Boitier en acier inoxydable
  - Surface de cuisson plate 15mm ST52
  - Surface de cuisson contrôlable à 4 zones indépendants - Mesures du four d'après GN 1/1
  - Température du four réglable (50°C-300°C)
  - Résistance du four contrôlable pour cuisson séperable haut et bas
  - Four isolé
  - Grille mobile GN 1/1
  - Pieds réglable



**GAST-7KKZ80**



## 700 LÜK SERİ / 700 SERIES / SÉRIE DES 700

### KAPALI ATEŞ GAZLI KUZİNE-OCAK / SOLID TOP GAS / CUISINIÈRE GAZ A FONTE

#### KAPALI ATEŞ GAZLI KUZİNE / SOLID TOP GAS / CUISINIÈRE GAZ A FONTE



TR

- Paslanmaz çelik gövde
- 3 parçalı sanayi tip döküm yüzey
- Emniyet ventilli valf
- Alev denetleme tertibatı
- Sanayi tipi döküm
- LPG ve Doğalgaza uyumlu
- Kolay temizlenebilir pislik tepsisi
- Piezoelektrik ateşlemeli, pilotlu
- Termostat kontrollü fırın 100-300°C arası ayarlanabilir - Fırın ölçüleri GN 2/1 göre
- İzolasyonlu fırın
- Seyyar GN 2/1 tel raf
- Ayarlanabilir ayaklar

EN

- Stainless steel body
- 3 pieces heavy duty cast iron
- Safety gas valve with thermocouple
- Fire inspect system
- Heavy duty top cast iron
- Available LPG or Natural Gas
- Easy to clean
- Piezoelectric ignition and pilot flame
- Oven thermostat adjustment between 100°C to 300°C - Oven size is GN 2/1
- Isolated oven
- Removable wire tray size GN 2/1
- Adjustable legs

FR

- Boîtier en acier inoxydable
- 3 pièces en fonte robuste
- Thermo couple
- Dispositif du contrôle de feu
- Fonte de type industriel
- Compatible au GPL- Gaz Naturel
- Nettoyage facile de la saleté du plateau
- Pilote d'allumage piézo-électrique
- Thermostat contrôle cuisson (100°C-300°C) - Dimension du four selon GN 2/1
- Four isolé
- Grille mobile GN 2/1
- Pieds réglable



GAST-7KKZG80

**930 LUK SERİ 930**  
SERIES / Série des 930





# 930 LUK SERI

## 930 SERIES

### Série des 930

930 SERIES

**930 LUK SERİ / 930 SERIES SÉRIE DES 930**  
**/ FRİTÖZLER / FRYERS / FRITEUSES**

**40 LİK TEKLİ ELEKTRİKLİ FRİTÖZ / ELECTRIC FRYER WITH 1 BASKET /**



- TR**
- Paslanmaz çelik gövde
  - Hareketli ısıtıcılar sayesinde kolay temizlik - Hijyenik
  - Tahliye vanası
  - Yekpare bankolu havuz
  - Emniyet termostadı
  - 100-180°C ayarlı termostat
  - 24+24 litre kızartma kapasitesi
  - Ayarlanabilir ayaklar
  - Uzun ömürlü



**GAST-9FE40**

- EN**
- Stainless steel body
  - Easy to clean
  - Hygienic
  - With drainage pipe
  - Monoblock baskets
  - Safety thermostat
  - 100-180°C Adjustable thermostat
  - 24 lt frying capacity for each bowls - Adjustable legs
  - Long life

**80 LİK ÇİFTLİ ELEKTRİKLİ FRİTÖZ / ELECTRIC FRYER WITH 2 BASKETS /**



- FR**
- Panier en acier inoxydable.
  - L'élément de chauffage mobile permet une maintenance facile.
  - Vanne de vidange d'huile.
  - Commande thermostatique.
  - Sécurité de la surchauffe avec thermostat.
  - Nettoyage facile grâce à la conception hygiénique.
  - Corps en acier inoxydable

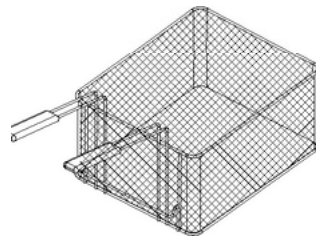

**GAST-9FE80**



**930 LUK SERİ / 930 SERIES SÉRIE DES 930**  
**/ FRİTÖZLER / FRYERS / FRITEUSES**

**40 LİK TEKLİ GAZLI FRİTÖZ / GAS FRYER WITH 1 BASKET /**



- TR**
- Paslanmaz çelik gövde
  - Piezoelektrik ateşlemeli pilot
  - LPG ve Doğalgaza uyumlu
  - Hareketli ısıtıcılar sayesinde kolay temizlik - Hijyenik
  - Tahliye vanası
  - Yekpare bankolu havuz
  - Emniyet termostadı
  - 100-180°C ayarlı termostat
  - 24 litre kızartma kapasitesi
  - Ayarlanabilir ayaklar
  - Uzun ömürlü

- EN**
- Stainless steel body
  - Safety gas thermostat 100°C-180°C
  - Piezoelectric ignition and pilot flame - Easy to clean
  - Hygienic
  - With drainage pipe
  - Monoblock basket
  - Safety thermostat
  - 100-180°C Adjustable thermostat
  - 24 lt frying capacity for each bowls
  - Adjustable legs
  - Long life



**GAST-9FG40**

930 SERIES

**80 LİK ÇİFTLİ GAZLI FRİTÖZ / GAS FRYER WITH 2 BASKETS /**



- FR**
- Adaptable à fonctionner au GPL ou GN.
  - Commande thermostatique.
  - Panier en acier inoxydable.
  - L'élément de chauffage mobile permet une maintenance facile. - Vanne de vidange d'huile.
  - Commande thermostatique.
  - Sécurité de la surchauffe avec thermostat.
  - Nettoyage facile grâce à la conception hygiénique.
  - Corps en acier inoxydable

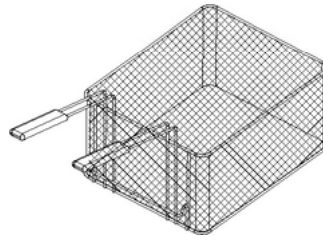

**GAST-9FG80**

**930 LUK SERİ / 930 SERIES / SÉRIE DES 930**  
**ELEKTRİKLİ OCAKLAR / ELECTRIC COOKERS / CUISINIÈRE ELECTRIQUE**

**2 Lİ ELEKTRİKLİ OCAK / ELECTRIC COOKER WITH 2 HOT PLATES /**



- TR**
- Paslanmaz çelik gövde
  - Pik dökümlü 30x30 cm 4 kW pleytler -
  - 6 Kademeli kontrol edilebilir
  - Kolay temizlenebilir
  - Ayarlanabilir ayaklar
  - Uzun ömürlü



**GAST-90CE240**

**4 LÜ ELEKTRİKLİ OCAK / ELECTRIC COOKER WITH 4 HOT PLATES /**



- EN**
- Stainless steel body
  - 30x30 cm 4 kW hot plates - 6 levels of switch control
  - Adjustable legs
  - Easy to clean
  - Long life



**GAST-90CE480**

**6 LI ELEKTRİKLİ OCAK / ELECTRIC COOKER WITH 6 HOT PLATES /**



- FR**
- Boîtier en acier inoxydable.
  - Dimension fontes 30x30 cm plaques 4 kw. - Contrôlable a 6 niveaux.
  - Pieds réglable



**GAST-90CE6120**

**930 LUK SERİ / 930 SERIES / SÉRIE DES 930**  
**GAZLI OCAKLAR / GAS COOKERS / CUISINIÈRE A GAZ**

**2 Lİ GAZLI OCAK / GAS COOKER WITH 2 BURNERS / CUISINIÈRE A GAZ**



- TR**
- Paslanmaz çelik gövde
  - Emniyet ventilli valf
  - Alev denetleme tertibatı
  - Pilot yanış sistemi
  - Sanayi tipi döküm
  - LPG ve Doğalgaza uyum - Kolay temizlenebilir
  - Ayarlanabilir ayaklar
  - Uzun ömürlü



**GAST-90CG240**

**4 LÜ GAZLI OCAK / GAS COOKER WITH 4 BURNERS / CUISINIÈRE A GAZ**



- EN**
- Stainless steel body
  - Safety gas valve with thermocouple
  - Fire inspect system
  - Heavy duty top cast iron
  - Available LPG and Natural Gas
  - Adjustable legs
  - Easy to clean
  - Long life



**GAST-90CG480**

**6 LI GAZLI OCAK / GAS COOKER WITH 6 BURNERS / CUISINIÈRE A GAZ**



- FR**
- Adaptable à fonctionner au GPL et GN.
  - Soupape de sécurité magnétique.
  - La fonte supérieure permet une excellente résistance aux chocs.
  - Nettoyage facile grâce à la conception hygiénique.



**GAST-90CG6120**

40 LİK ELEKTRİKLİ PLEYT IZGARA / ELECTRIC GRILL PLATE /



- TR**
- Paslanmaz çelik gövde
  - Pişirme yüzeyi düz, yarı oluklu ve tam oluklu
  - 80'lik modellerde ayrı ayrı kontrol edilebilen pişirme yüzeyi - 50-300°C termostat
  - Homojen pişirme yüzeyi
  - Yağ toplama kanalı, boşaltma çekmecesini
  - Ayarlanabilir ayaklar
  - Uzun ömürlü



GAST-9PIE40YO

80 LİK ELEKTRİKLİ PLEYT IZGARA / ELECTRIC GRILL PLATE /



- EN**
- Stainless steel body
  - Types of cooking plate (smooth, 1/2 nervour and nervour) - Thermostat adjustment between 50-300°C
  - Equal temperature distribution on the cooking surface
  - Fat collecting drawer
  - Adjustable legs
  - Long life

- FR**
- Boîtier en acier inoxydable
  - 3 Modèles de cuisson, surface lisse, demi rainuré ou rainuré
  - Contrôle de cuisson séparable sur surface plate 1 modèle
  - 80 - Surface de cuisson réglable (50°C-300°C)
  - Pieds réglable
  - Surface de cuisson homogène
  - Canal de collecte de graisse- Tiroir décharge
  - Nettoyage facile
  - Utilisable sur planche ou armoire



GAST-9PIE80YO



40 LİK ELEKTRİKLİ KROM PLEYT IZGARA / ELECTRIC CHROME GRILL PLATE   

- TR**
- Paslanmaz çelik gövde
  - Pişirme yüzeyi düz, yarı oluklu ve tam oluklu
  - Krom pişirme yüzeyi
  - 80'lik modellerde ayrı ayrı kontrol edilebilen pişirme yüzeyi - 50-300°C termostat
  - Homojen pişirme yüzeyi
  - Yağ toplama kanalı, boşaltma çekmecesesi
  - Ayarlanabilir ayaklar
  - Uzun ömürlü



GAST-9PIKE40YO

80 LİK ELEKTRİKLİ KROM PLEYT IZGARA / ELECTRIC CHROME GRILL PLATE   

- EN**
- Stainless steel body
  - Types of cooking plate (smooth, 1/2 nervour and nervour) - Chrome cooking surface
  - Thermostat adjustment between 50-300°C
  - Equal temperature distribution on the cooking surface
  - Fat collecting drawer
  - Adjustable legs
  - Long life

- FR**
- Boitier en acier inoxydable
  - 3 Modèles de cuisson, surface lisse, demi rainuré ou rainuré
  - Cuisson chrome
  - Contrôle de cuisson séparable sur surface plate 1 modèle
  - 80 - Surface de cuisson réglable (50°C-300°C)
  - Pieds réglable
  - Surface de cuisson homogène
  - Canal de collecte de graisse- Tiroir décharge
  - Nettoyage facile
  - Utilisable sur planche ou armoire



GAST-9PIKE80YO

40 LİK PLEYT GAZLI IZGARA / GAS GRILL PLATE GRILL A GAZ



- TR**
- Paslanmaz çelik gövde
  - Pişirme yüzeyi düz, yarı oluklu ve tam oluklu
  - 80'lik modellerde ayrı ayrı kontrol edilebilen pişirme yüzeyi - Homojen pişirme yüzeyi
  - Yağ toplama kanalı, boşaltma çekmecesini
  - Ayarlanabilir ayaklar
  - Uzun ömürlü
  - LPG ve Doğalgaza uyumlu
  - Piezoelektrik ateşlemeli, pilotlu



GAST-9PIG40YO

80 LİK PLEYT GAZLI IZGARA / GAS GRILL PLATE GRILL A GAZ



- EN**
- Stainless steel body
  - Types of cooking plate (smooth, 1/2 nervour and nervour) - 80 cm models have double indepented cooking zone
  - Equal temperature distribution on the cooking surface
  - Fat collecting drawer
  - Adjustable legs
  - Long life
  - Available LPG and Natural Gas
  - Piezoelectric ignition, pilot flame

- FR**
- Boitier en acier inoxydable
  - 3 Modèles de cuisson, surface lisse, demi rainuré ou rainuré
  - Contrôle de cuisson séparable sur surface plate 1 modèle
  - 80 - Pieds réglable
  - Surface de cuisson homogène
  - Canal de collecte de graisse- Tiroir décharge
  - Nettoyage facile
  - Utilisable sur planche ou armoire



GAST-9PIG80YO

**930 LUK SERİ / 930 SERIES / SÉRIE DES 930**  
**PLEYT GAZLI KROM IZGARALAR / GAS CHROME GRILLS PLATE / GRILLS A GAZ CHROME**

**40 LİK PLEYT GAZLI KROM IZGARA / GAS CHROME GRILL PLATE CHROME**   

- TR**
- Paslanmaz çelik gövde
  - Pişirme yüzeyi düz, yarı oluklu ve tam oluklu
  - Krom pişirme yüzeyi
  - 80'lik modellerde ayrı ayrı kontrol edilebilen pişirme yüzeyi - Homojen pişirme yüzeyi
  - Yağ toplama kanalı, boşaltma çekmecesini
  - Ayarlanabilir ayaklar
  - Uzun ömürlü
  - LPG ve Doğalgaza uyumlu
  - Piezoelektrik ateşlemeli, pilotlu



**GAST-9PIKG40YO**

**80 LİK PLEYT GAZLI KROM IZGARA / GAS CHROME GRILL PLATE CHROME**   

- EN**
- Stainless steel body
  - Types of cooking plate (smooth, 1/2 nervour and nervour) - Chrome cooking surface
  - 80 cm models have double indepented cooking zone
  - Equal temperature distribution on the cooking surface
  - Fat collecting drawer
  - Adjustable legs
  - Long life
  - Available LPG and Natural Gas
  - Piezoelectric ignition, pilot flame

- FR**
- Boitier en acier inoxydable
  - 3 Modèles de cuisson, surface lisse, demi rainuré ou rainuré
  - Cuisson chrome
  - Contrôle de cuisson séparable sur surface plate 1 modèle
  - 80 - Pieds réglable
  - Surface de cuisson homogène
  - Canal de collecte de graisse- Tiroir décharge
  - Nettoyage facile
  - Utilisable sur planche ou armoire



**GAST-9PIKG80YO**

**930 LUK SERİ / 930 SERIES / SÉRIE DES 930**  
**LAVATAŞ IZGARALAR / LAVASTONE GRILLS / GRILL A PIERRE DE LAVE**

**40 LİK LAVATAŞ IZGARA/ LAVASTONE GRILL / GRILL A PIERRE DE LAVE**



- TR**
- Paslanmaz çelik gövde
  - Emniyet ventilli valf
  - Alev denetleme tertibatı
  - Piezoelektrik ateşlemeli, pilotlu
  - LPG ve Doğalgaza uyumlu
  - Yağ toplama kanalı, boşaltma çekmecesini -
  - Ayarlanabilir ayaklar
  - Kolay temizlenebilir
  - Uzun ömürlü



**GAST-9LIG40**

**80 LİK LAVATAŞ IZGARA/ LAVASTONE GRILL / GRILL A PIERRE DE LAVE**



- EN**
- Stainless steel body
  - Safety gas valve with thermocouple - Fire inspect system
  - Piezoelectric ignition, pilot flame
  - Available LPG and Natural Gas
  - Fat collecting drawer
  - Adjustable legs
  - Easy to clean
  - Long life
- FR**
- Boitier en acier
  - Thermo couple
  - Pilote d'allumage piézo-électrique
  - Compatible au GPL et gaz naturel
  - Canal de collecte de graisse–Tiroir de décharge - Pieds réglable
  - Nettoyage facile
  - Utilisable sur planche ou armoire



**GAST-9LIG80**



**930 LUK SERİ / 930 SERIES / SÉRIE DES 930**  
**DÖKÜM IZGARALAR / CAST IRON GRILL / GRILL EN FONTE**



**DÖKÜM IZGARA / CAST IRON GRILL / GRILL EN FONTE**

- TR**
- Paslanmaz çelik gövde
  - Emniyet ventilli valf
  - Alev denetleme tertibatı
  - Piezoelektrik ateşlemeli, pilotlu
  - Su çekmecesini
  - Döküm pişirme yüzeyi
  - LPG ve Doğalgaza uyumlu
  - Yağ toplama kanalı, boşaltma çekmecesini -
  - Ayarlanabilir ayaklar
  - Kolay temizlenebilir
  - Uzun ömürlü

- EN**
- Stainless steel body
  - Safety gas valve with thermocouple - Fire inspect system
  - Piezoelectric ignition, pilot flame
  - Available LPG and Natural Gas
  - Water drawer
  - Cast iron surface
  - Fat collecting drawer
  - Adjustable legs
  - Easy to clean
  - Long life

- FR**
- Cabinet vapeur rend la cuisson plus facile.
  - Adaptable à fonctionner au GPL et GN.
  - Soupape de sécurité magnétique.
  - Chauffage bi-zone sur le module complet
  - Contrôle par l'allumage Piezo pour chaque brûleurs.
  - Plaque en fonte.
  - Nettoyage facile grâce à la conception hygiénique.
  - Corps en acier inoxydable.



**GAST-9DIG80**

**930 LUK SERİ / 930 SERIES / SÉRIE DES 930**  
**PATATES DİNLENDİRME / HEATED CHIPS UNIT / REPOSE POMME DE TERRE**

**PATATES DİNLENDİRME / HEATED CHIPS UNIT / REPOSE POMME DE TERRE**   

- TR** - Paslanmaz çelik gövde  
- Ayarlanabilir ayaklar  
- Kolay temizlenebilir  
- Uzun ömürlü

- EN** - Stainless steel  
body - Adjustable  
legs  
- Easy to clean  
- Long life

- FR** - Permet de garder les frites au chaud et d'égouter  
l'huile.  
- Capacité du bac; GN 1/1 x 150 mm.  
- La forme spéciale sur le conteneur, permet une  
efficacité maximale pour vidanger l'huile.  
- Nettoyage facile grâce à la conception hygiénique.  
- Corps en acier inoxydable.



**GAST-9PDE40**

**930 LUK SERİ / 930 SERIES / SÉRIE DES 930**  
**MAKARNA HAŞLAMA / PASTA COOKER / CUISSEUR A PÂTE**

**MAKARNA HAŞLAMA / PASTA COOKER / CUISSEUR A PÂTE**



930 SERIES

- TR**
- Paslanmaz çelik gövde
  - Kolay temizlenebilir
  - Hijyenik
  - Tahliye vanası
  - Yekpare bankolu havuz
  - 30-120°C ayarlı termostat
  - 24 lt kaynatma kapasitesi
  - Ayarlanabilir ayaklar
  - Uzun ömürlü

- EN**
- Stainless steel body
  - Easy to clean
  - Hygienic
  - With drainage pipe
  - Monoblock bowl
  - 30-120°C Adjustable thermostat - 24 Liter boilig capacity
  - Adjustable legs
  - Long life

- FR**
- Commande thermostatique.
  - Panier en acier inoxydable.
  - Robinet de remplissage d'eau.
  - Robinet de vidange.
  - Système de drainage de l'eau débordant.
  - Nettoyage facile grâce à la conception hygiénique.
  - Corps en acier inoxydable.



**GAST-9MH40**

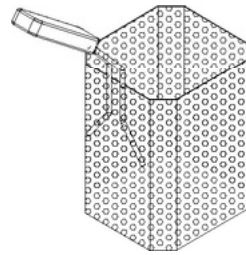

40 LİK BENMARİ / BAIN-MARIE BAIN-MARIE



- TR**
- Paslanmaz çelik gövde
  - Gastronom küvetlere uygun hazne - Kolay temizlenebilir
  - Hijyenik
  - Tahliye vanası
  - Yekpare havuz
  - 30-120°C ayarlı termostat
  - Ayarlanabilir ayaklar
  - Uzun ömürlü



GAST-9BM40

80 LİK BENMARİ / BAIN-MARIE / BAIN-MARIE



- EN**
- Stainless steel body
  - Reservoir available for gastronom cups - Easy to clean
  - Hygienic
  - Drainage pipe
  - Nonoblock bowl
  - 30-120°C Adjustable thermostat
  - Adjustable legs
  - Long life

- FR**
- Commande thermostatique.
  - Capacité de module-demi; 1 GN 1/1.
  - Capacité de module-complet; 2 x GN 1/1.
  - Robinet de remplissage d'eau.
  - Nettoyage facile grâce à la conception hygiénique.
  - Corps en acier inoxydable.



GAST-9BM80

**930 LUK SERİ / 930 SERIES / SÉRIE DES 930**  
**NÖTR TEZGAH / NOTR BENCH / COMPTOIR NEUTRE**

**40 LİK NÖTR TEZGAH / NOTR BENCH / COMPTOIR NEUTRE**



- TR**
- Paslanmaz çelik gövde
  - Ayarlanabilir ayaklar
  - Kolay temizlenebilir
  - Uzun ömürlü

- EN**
- Stainless steel body - Adjustable legs
  - Easy to clean
  - Long life



**GAST-9NT40**

**80 LİK NÖTR TEZGAH / NOTR BENCH / COMPTOIR NEUTRE**



- FR**
- Idéal pour la préparation.
  - Nettoyage facile grâce à la conception hygiénique.
  - Corps en acier inoxydable.



**GAST-9NT80**



- TR**
- Paslanmaz çelik gövde
  - Karşı ağırlıklı katlanır kapak
  - Komple mıknatıslı güvenlik valfli brülör
  - Ateşleme ve durdurma düğmesini birlikte içeren pilot termokuplu.
  - Soğuk ve sıcak su doldurma musluğu
  - Drenaj musluğu



- EN**
- Stainless steel body
  - Counterweighted folding lid
  - Burner with complete magnet security valve
  - Which contains ignition and stop button together with pilot thermocouple
  - Cold and hot water filling cock
  - Drainage cock

**GAST-9KT80**

- FR**
- Contrôle de la valve sous-présion avec le manomètre. - Robinet de remplissage d'eau chaude et froide.
  - Robinet de drainage.
  - Clapet de surcharge.
  - Bac avec double casseroles.
  - Nettoyage facile grâce à la conception hygiénique.
  - Corps en acier inoxydable.



# 930 LUK SERİ / 930 SERIES / SÉRIE DES 930 DEVRİLİR TAVALAR / TILTING BRATT PAN / SAUTEUSES BASCULANTE

## DEVİRİLİR TAVA / TILTING BRATT PAN / SAUTEUSES BASCULANTE



- TR**
- Gövde, panel, tava paslanmaz çelik
  - Kaldırma mekanizması el ile çalışır
  - Paslanmaz çelik brülör ateşlemeli, pilotlu termokuplu ve termostatlı
  - Alev sönerse gaz kesilir
  - LPG ve Doğalgaza uyumludur
  - Cihaz üstündeki musluk ile doldurma ve yıkama yapmaktır kolaydır



GAST-9DT80

- EN**
- Body, panelling and pan made of stainless steel - The tilting mechanism is manual operated
  - Stainless steel burner with ignition, pilot thermocouple and thermostat
  - If the flame goes out, gas is cut off
  - Operable with LPG and Natural Gas
  - Filling with faucet on top of device and washing is easy



GAST-9DTG120

- FR**
- Système de levage manuel.
  - Clapet de surcharge.
  - Interrupteur de sécurité.
  - Nettoyage facile grâce à la conception hygiénique.
  - Construction en acier inoxydable.

**930 LUK SERİ / 930 SERIES / SÉRIE DES 930**  
**ELEKTRİKLİ KUZİNELER / ELECTRIC RANGES / CUISINIÈRES ELECTRIQUE**

**4 LÜ ELEKTRİKLİ KUZİNE / ELECTRIC RANGE WITH 4 HOT**  
**PLATES / CUISINIÈRE ELECTRIQUE**



- TR**
- Paslanmaz çelik gövde
  - Pik dökümü 30x30 cm 4 kW pleytler
  - 6 kademeli kontrol edilebilir
  - Fırın ölçüleri GN 2/1 göre
  - Fırın sıcaklığı 50-300°C arası ayarlanabilir
  - Fırın içi rezistanlar alt ve üst olarak ayrı ayrı kontrol edilebilir
  - İzolasyonlu fırın
  - Seyyar GN 2/1 tel raf
  - Ayarlanabilir ayaklar



**GAST-9K Z80**

**6 LÜ ELEKTRİKLİ KUZİNE / ELECTRIC RANGE WITH 6 HOT**  
**PLATES / CUISINIÈRE ELECTRIQUE**



- Stainless steel body
- 30x30 cm 4 kW heaters
- Adjustable control system
- Oven size is GN 2/1
- Oven thermostat adjustment between 50°C to 300°C
- Oven heaters work separately or together - Isolated oven
- Removable wire tray size GN 2/1
- Adjustable legs

- FR**
- Boitier en acier inoxydable
  - Dimensions fontes 30x30cm plaques 4kw
  - Contrôlable à 6 niveaux
  - Dimensions du four selon GN 2/1
  - Température du four réglable 50°C-300°C
  - Température résistance, réglable séparément pour cuisson supérieure et inférieure
  - isolation thermique
  - Grilles mobiles GN 2/1
  - Pieds réglable



**GAST-9KZ120**

4 LÜ GAZLI KUZİNE / GAS RANGE WITH 4 BURNERS / CUISINIÈRE A GAZ



- TR**
- Paslanmaz çelik gövde
  - Emniyet ventilli valf
  - Alev denetleme tertibatı
  - Sanayi tipi döküm
  - LPG ve Doğalgaza uyumlu
  - Piezoelektrik ateşlemeli, pilotlu
  - Fırın ölçüleri GN 2/1 göre
  - Fırın sıcaklığı 50-300°C arası ayarlanabilir
  - İzolasyonlu fırın
  - Seyyar GN 2/1tel raf
  - Kolay temizlenebilir
  - Ayarlanabilir ayaklar



GAST-9KZG80

6 LI GAZLI KUZİNE / GAS RANGE WITH 6 BURNERS / CUISINIÈRE A GAZ



- EN**
- Stainless steel body
  - Safety gas valve with thermocouple
  - Fire inspect system
  - Heavy duty top cast iron
  - Available LPG and Natural Gas
  - Piezoelectric ignition and pilot flame
  - Adjustable control system
  - Oven size GN 2/1
  - Oven thermostat adjustable from 50°C to 300°C - Isolated oven
  - Removable wire tray size GN 2/1
  - Easy to clean
  - Adjustable legs



GAST-9KZG120

- FR**
- Adaptable à fonctionner au GPL et GN.
  - Construction interne complètement en acier inoxydable avec des plateaux 2xGN 2/1.
  - Vanne de gaz thermostatique réglable.
  - Soupape de sécurité magnétique.
  - La fonte supérieur permet une excellente résistance aux chocs.
  - Contrôle par l'allumage Piezo pour chaque brûleurs.
  - Nettoyage facile grâce à la conception hygiénique.
  - Corps en acier inoxydable.

# 930 LUK SERİ / 930 SERIES / SÉRIE DES 930 KAPALI ATEŞ ELEKTİRİKLİ KUZİNE-OCAK / ELECTRIC SOLID TOP

/ CUISINIÈRE ELECTRIQUE A FONTE

## KAPALI ATEŞ ELEKTİRİKLİ KUZİNE / ELECTRIC SOLID TOP / CUISINIÈRE ELECTRIQUE A FONTE

- Paslanmaz çelik gövde
- Pişirme yüzeyi 15mm ST52 Pleyt
- 4 bölge kontrol edilebilen pişirme yüzeyi
- Fırın ölçüleri GN 1/1 göre
- Fırın sıcaklığı 50°C-300°C arası ayarlanabilir - Fırın içi rezistanslar alt ve üst olarak ayrı ayrı kontrol edilir
- İzolasyonlu fırın
- Seyyar GN 1/1 tel raf
- Ayarlanabilir ayaklar



EN

- Stainless steel body
- Type of cooking plate 15mm ST52
- Cooking surface able to control by 4 independent zones
- Oven size is GN 1/1
- Oven thermostat adjustment between 50°C to 300°C
- Oven heaters work separately or together
- Isolated oven
- Removable wire tray size GN 1/1
- Adjustable legs

FR

- Boîtier en acier inoxydable
- Surface de cuisson plate 15mm ST52
- Surface de cuisson contrôlable à 4 zones indépendants - Mesures du four d'après GN 1/1
- Température du four réglable (50°C-300°C)
- Résistance du four contrôlable pour cuisson séparable haut et bas
- Four isolé
- Grille mobile GN 1/1
- Pieds réglable

GAST-9KKZ80



**930 LUK SERİ / 930 SERIES / SÉRIE DES 930**  
**KAPALI ATEŞ GAZLI KUZİNE-OCAK / SOLID TOP GAS WITH OVEN / CUISINIÈRE GAZ A FONTE**

TR

- Paslanmaz çelik gövde
- 3 parçalı sanayi tip döküm yüzey
- Emniyet ventilli valf
- Alev denetleme tertibatı
- Sanayi tipi döküm
- LPG ve Doğalgaza uyumlu
- Kolay temizlenebilir pislik tepsisi
- Piezoelektrik ateşlemeli, pilotlu
- Termostat kontrollü fırın 100-300°C arası ayarlanabilir - Fırın ölçüleri GN 2/1 göre
- İzolasyonlu fırın
- Seyyar GN 2/1 tel raf
- Ayarlanabilir ayaklar

EN

- Stainless steel body
- 3 pieces heavy duty cast iron
- Safety gas valve with thermocouple
- Fire inspect system
- Heavy duty top cast iron
- Available LPG or Natural Gas
- Easy to clean
- Piezoelectric ignition and pilot flame
- Oven thermostat adjustment between 100°C to 300°C - Oven size is GN 2/1
- Isolated oven
- Removable wire tray size GN 2/1
- Adjustable legs

FR

- Boitier en acier inoxydable
- 3 pièces en fonte robuste
- Thermo couple
- Dispositif du contrôle de feu
- Fonte de type industriel
- Compatible au GPL- Gaz Naturel
- Nettoyage facile de la saleté du plateau
- Pilote d'allumage piézo-électrique
- Thermostat contrôle cuisson (100°C-300°C) - Dimension du four selon GN 2/1
- Four isolé
- Grille mobile GN 2/1
- Pieds réglable



**GAST-9KKZG80**



**RoseBuild**



# KAFETERYA CAFE TERIA Cafeterias





**3 LÜ MOTORLU DÖNER OCAĞI / DONER MACHINE WITH 3 BURNERS (LOWER DRIVE)**  
**/ MACHINE A KEBAB A 3 RADIANTS**



**TR**

- Paslanmaz çelik gövde
- LPG ve Doğalgaza uyumlu
- Emniyet ventilli valf
- Alev denetleme tertibatı
- Alev paneli
- Kolay temizlenebilir
- Radyanlar max-min olarak bağımsız çalışır
- Alttan motorlu, elektrikli
- Yağ toplama tepsisi, boşaltma çekmecesini
- Gövdenin hareketi ile döner ve radyan arası ayarlanabilir

**EN**

- Stainless steel body
- Available LPG and Natural Gas
- Safety gas valve with thermocouple
- Fire inspect system
- Fire panel
- Easy to clean
- The heating elements able to work separately
- Electrical lower drive
- With removable fat collecting drawer
- Moving body



**GAST-MD03**

**4 LÜ MOTORLU DÖNER OCAĞI / DONER MACHINE WITH 4 BURNERS (LOWER DRIVE)**  
**/ MACHINE A KEBAB A 4 RADIANTS**



**FR**

- Boitier en acier inoxydable
- Compatible au GPL et Gaz Natural
- Thermo couple
- Dispositif de surveillance de flamme
- Panneau de flamme
- Nettoyage facile
- Fonctionnement indépendant des radiants au max-minimum -
- Moteur électrique est en bas
- Canal de collecte de graisse-Trioir dégager
- Réglage du pivotement du doner et radiant



**GAST-MD04**

**MACHINE A KEBAB MACHINE A KEBAB**

- Paslanmaz çelik gövde
- LPG ve Doğalgaza uyumlu
- Emniyet ventilli valf
- Alev denetleme tertibatı
- Alev paneli
- Kolay temizlenebilir
- Radyanlar max-min olarak bağımsız çalışır

- Stainless steel body
- Available LPG and Natural Gas
- Safety gas valve with thermocouple
- Fire inspect system
- Fire panel
- Easy to clean
- The heating elements able to work seperately



**GAST-D03**

CAFE

**4 LÜ DÖNER OCAĞI / DONER GRILL MACHINE  
/ MACHINE A KEBAB A 4 RADIANTS**



**FR**

- Boitier en acier inoxydable
- Compatible au GPL en GAZ naturel
- Thermo couple
- Dispositif de surveillance de flamme
- Panneau de flamme
- Fonctionnement indépendant des radiants



**GAST-D04**



**TR**

- Paslanmaz çelik gövde
- Kolay temizlenebilir
- Spot aydınlatmalı
- GN-2/3 göre

**EN**

- Stainless steel body
- Easy to clean
- Long life
- Spotlight
- GN-2/3

**FR**

- Boitier en acier inoxydable - Nettoyage facile
- Éclairage en spot
- Système GN-2/3



**GAST-LKS500**



## 40 LİK ISLAK HAMBURGER / SAUCE HAMBURGER MACHINE / MACHINE POUR HAMBURGER HUMIDE

TR

- Paslanmaz çelik gövde
- Çift buhar hazneli
- Spot aydınlatmalı
- Hijyenik
- Tahliye vanası
- 30°-120°C termostat kontrollü
- Su sızdırmazlık, izolasyonlu
- Yekpare havuz
- Kolay temizlenebilir
- Ayarlanabilir ayaklar

EN

- Stainless steel body
- Double steam boiler
- Spotlight
- Hygienic
- With water drainage
- Thermostat adjustment from 30°C to 120°C
- Isolated
- One piece pool
- Easy to clean
- Adjustable legs



GAST-IHB40

## 60 LİK ISLAK HAMBURGER / SAUCE HAMBURGER MACHINE / MACHINE POUR HAMBURGER HUMIDE



FR

- Boitier en acier inoxydable
- Réservoir a double vapeur
- Eclairage en spot
- Hygiénique
- Soupape d'évacuation
- Thermostat contrôle (30°C-120°C) - Isolation contre fuites d'eau
- Bac monobloc
- Nettoyage facile
- Pieds réglable



GAST-IHB60

45 LİK HAREKETLİ SALAMANDER / LIFT SALAMENDER / SALAMANDRE



TR

- Paslanmaz çelik gövde
- Kolay temizlenebilir
- 2 kademeli kontrol edilebilir

EN

- Stainless steel body
- Easy to clean
- Adjustable thermostat



GAST-HSE45

65 LİK HAREKETLİ SALAMANDER / LIFT SALAMENDER / SALAMANDRE



FR

- Boîtier en acier inoxydable
- Nettoyage facile
- Contrôle à 2 niveaux



GAST-HSE65

## BENMARİ / BAIN-MARIE / BAIN MARIE



TR

- Paslanmaz çelik gövde
- Kolay temizlenebilir
- Taban raflı, etrafı kapalı
- 30°-120° termostat kontrolü
- Tahliye vanası

EN

- Stainless steel body
- With cupboard
- Easy to clean
- 30°-120° adjustable thermostat
- Drainage pipe



GAST-BM400

## AHŞAP KAPLAMALI BENMARİ / WOOD COATING BAIN-MARIE / BAIN- MARIE HABILLAGE PLAQUE EN BOIS



FR

- Boitier en acier inoxydable
- Nettoyage facile
- Base à étagères contour fermé
- Thermostat contrôle (30°C-120°C) - Soupape d'évacuation



TR

- Paslanmaz çelik gövde
- Kolay temizlik
- Isı yalıtımlı
- 5 tepsi (80x60'e göre) kapasiteli
- LPG ve Doğalgaz uyumlu
- Isıya dayanıklı çift camlı kapı
- Piezoelektrik ateşlemeli, pilotlu
- Emniyet sistemli musluk
- Paslanmaz atmosferik brülörler
- Ürün alt grup ve üst grup olarak iki parçadan oluşur.



GAST-PBRK90

EN

- Stainless steel body
- Easy to clean
- 5 trays capacity
- Available Natural Gas and LPG
- Resistant to heating double glass
- Piezoelectricity firing and pilot system
- Safety system
- Stainless steel atmospheric burners system
- Created by independence two pieces



GAST-PBRK75

FR

- Boîtier en acier inoxydable
- Nettoyage facile
- Isolation thermique
- Capacité de cuisson à 5 plateaux (selon GN 2/1)
- Double portes vitrées résistantes à la chaleur
- Pilote d'allumage piézo-électrique
- Robinet avec système sécurité
- Brûleurs atmosphériques inoxydables
- Four avec support





RANGES

**KUZINELER**  
**RANGES**  
**Cuisinières**

- TR**
- Paslanmaz çelik gövde
  - Pik dökümlü 30x30 cm 4 kW pleytler
  - 6 kademeli kontrol edilebilir
  - Fırın ölçüleri GN 2/1 göre
  - Fırın sıcaklığı 50-300°C arası ayarlanabilir
  - Fırın içi rezistanslar alt ve üst olarak ayrı ayrı kontrol edilir
  - İzolasyonlu fırın
  - Seyyar GN 2/1 tel raf
  - Ayarlanabilir ayaklar

- EN**
- Stainless steel body
  - 30x30 cm 4 kW plate
  - Adjustable control system
  - Oven size is GN 2/1
  - Oven thermostat adjustment from 50°C to 300°C
  - For oven resistances work separately or together
  - Isolated oven
  - Removable wire tray size GN 2/1
  - Adjustable legs

- FR**
- Boîtier en acier inoxydable
  - Dimensions fontes 30x30 cm plaques 4 kW
  - Contrôlable à 6 niveaux
  - Dimensions du four selon GN 2/1
  - Température du four réglable 50°C-300°C
  - Température résistance, réglable séparément pour cuisson supérieure et inférieure
  - Isolation thermique
  - Grilles mobiles GN 2/1
  - Pieds réglable



GAST-KZE4100

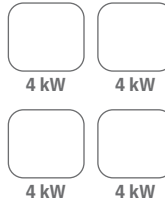

**GAZLI KUZİNELER / GAS RANGES / CUISINIÈRE À GAZ**

TR

- Paslanmaz çelik gövde
- Emniyet ventilli valf
- Alev denetleme tertibatı
- 40x50 Sanayi tipi döküm
- LPG ve Doğalgaza uyumlu
- Kolay temizlenebilir pislik tepsisi
- Piezoelektrik ateşlemeli, pilotlu
- Fırın ölçüleri GN 2/1 göre
- Termostat kontrollü fırın 100-300°C arası ayarlanabilir - İzolasyonlu fırın
- Seyyar GN 2/1 tel raf
- Ayarlanabilir ayaklar



GAST-KUZG4100

EN

- Stainless steel body
- Safety gas valve with thermocouple
- Fire inspect system
- Heavy duty top cast iron
- Available LPG or Natural Gas
- Easy to clean
- Piezoelectric ignition and pilot flame
- Oven size is GN 2/1
- Oven thermostat adjustment from 100°C to 300°C - Isolated oven
- Removable wire tray size GN 2/1
- Adjustable legs



FR

- Boitier en acier inoxydable
- Thermocouple
- Dispositif de surveillance de flamme
- Fonte type industriel
- Compatible au GPL et Gaz Natural
- Nettoyage facile des plateaux
- Pilote d'allumage piézo-électrique
- Thermostat contrôle cuisson à 100°C-300°C - Dimension du four selon GN 2/1
- Isolation thermique
- Grilles mobiles GN 2/1
- Pieds réglable



GAST-KUZG6150

## GAZLI OCAKLAR / GAS COOKERS / CUISINIÈRE A GAZ



- TR**
- Paslanmaz çelik gövde
  - Emniyet ventilli valf
  - Alev denetleme tertibatı
  - Pilot yanış sistemi
  - Sanayi tipi döküm
  - LPG ve Doğalgaza uyumlu -
  - Ayarlanabilir ayaklar
  - Kolay temizlenebilir
  - Uzun ömürlü

- EN**
- Stainless steel body
  - Safety gas valve with thermocouple
  - Fire inspect system
  - Heavy duty top cast iron
  - Available LPG or Natural Gas
  - Adjustable legs
  - Easy to clean
  - Long life



**GAST-DOCG2100-DLP**



**GAST-DOCG2100**

- FR**
- Boîtier en acier inoxydable
  - Soupape de sécurité avec thermocouple
  - Système d'inspection des incendies - La fonte en haute résistance
  - GPL disponible ou gaz naturel
  - Pieds réglable
  - Facile à nettoyer
  - Longue durée de vie



**GAST-OCGK4150-DLP**

# KUZİNELER / RANGES KUZİNE MARİN / MARINE RANGE



## KUZİNE MARİN / MARINE RANGE / CUISINIÈRE MARINE

- TR**
- Paslanmaz çelik gövde
  - 30x30 cm 4 kW pik dökümlü pleytler
  - 6 kademeli kontrol edilebilir
  - Fırın ölçüleri GN 2/1–GN 1/1'e göre
  - Fırın sıcaklığı 50-300°C arası ayarlanabilir
  - Fırın içi rezistanslar alt ve üst olarak ayrı ayrı kontrol edilir - İzolasyonlu fırın
  - Alt ve üst bölüm 2 seyyar parçadan oluşur
  - Tencere devrilmelerini önlemek için yalpalıklar
  - Tencere büyüklüğüne göre ayarlanabilir yalpalıklar
  - Ayarlanabilir ve yere sabitlenebilir ayaklar

- EN**
- Stainless steel body
  - 30x30 cm 4 kW plate
  - Adjustable control system
  - Oven size is GN 2/1
  - Oven thermostat adjustment from 50°C to 300°C
  - For oven s work seperately or together
  - Isolated oven
  - Removable wire tray size GN 2/1
  - Upper and lower parts consists two portable tools
  - Holders can be adjusted according to the size of cookware - Roll holders to prevent tipping for cookware
  - Adjustable and fixed legs

- FR**
- Boitier en acier inoxydable
  - Fonte à 30x30 cm plaques 4 kW
  - Contrôle à 3 niveaux
  - Dimensions du four selon GN 2/1–GN 1/1
  - Température réglable 50°C-300°C
  - Résistances contrôlables pour cuisson séparée
  - Isolation thermique
  - Le bas et le haut du four intérieur se compose de 2 pièces mobiles - Soutien des récipients por éviter le renversement
  - Soutien selon dimension de récipient
  - Pieds réglable et fixables au sol

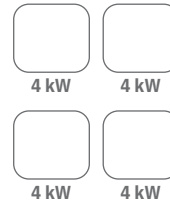

GAST-MKZ493

RANGES





# RoseBuild



**KOSAN OCAKLARI**  
**FLOOR COOKER**  
Cusinière à Sol

## ELEKTRİKLİ KOSAN OCAK / ELECTRIC STOVE



TR

- Paslanmaz çelik gövde
- Kolay temizlenebilir
- Pik dökümlü pleyt
- 6 kademeli kontrol edilebilir

FR

- Boitier en acier inoxydable
- Facile à nettoyer
- Fonte en fonte haute résistance - Thermostat réglable

EN

- Stainless steel body
- Easy to clean
- Heavy duty top cast iron
- Adjustable thermostat



GAST-K050

FLOOR COOKERS

## GAZLI KOSAN OCAK / GAS STOVE / CUISINIÈRE GAZ A SOL



TR

- Paslanmaz çelik gövde
- Kolay temizlenebilir pislik tepsisi
- LPG ve Doğalgaza uyumlu
- Sanayi tipi döküm
- CE standartlarına uygun emniyet sistemli
- Alçak basınçta yüksek güç üretebilen brülör
- Zemine sabitlenebilme özelliği

EN

- Stainless steel body
- Easy to clean dirty tray
- Available LPG or Natural Gas
- Safety system
- Burners create high power is in the low pressure
- 60x60 or 70x70 industrial type cast iron
- Available fixed in ground



GAST-KOG600

FR

- Boitier en acier inoxydable
- Nettoyage facile
- Compatible au GPL et Gaz Naturel
- Fonte de type industriel
- Système de sécurité selon le standard de CE - Sous basse pression, produit haute puissance des brûleur
- Fonte de type industriel
- Fixable au sol



GAST-KOG700





**RoseBuild**

**WOK OCAK**  
**WOK COOCKER**  
Cuiser Wok



## WOK OCAKLAR WOK STOVES /

### TEKLİ WOK OCAK / WOK STOVE WITH 1 BURNER ÇUISINIÈRE WOK



- TR**
- Paslanmaz çelik gövde
  - Yüksek güçlü pik döküm brülör
  - Alev denetleme tertibatı
  - Pilot alev sistemi
  - LPG ve doğalgaz uyumlu
  - Kolay temizlenebilir
  - Set üstü ve dolaplı kullanıma uygundur.



GAST-WK40

### ÇİFTLİ WOK OCAK / WOK STOVE WITH 2 BURNERS ÇUISINIÈRE WOK



- EN**
- Stainless steel
  - High power cast iron
  - Fire inspection system
  - Pilot flame
  - Available LPG or Natural Gas
  - Easy to clean
  - Available use over bench or cupboard



GAST-WK80

### ÜÇLÜ WOK OCAK / WOK STOVE WITH 3 BURNERS ÇUISINIÈRE WOK



- FR**
- Boitier en acier inoxydable
  - Thermocouple
  - Dispositif de surveillance de flamme - Fonte de type industriel
  - Compatible au GPL / Gas naturel
  - Nettoyage facile
  - Utilisation sur planche ou armoire



GAST-WK120

## ELEKTRİKLİ PATİSSERİ FIRINI / ELECTRIC PASTRY COOKER / PATE ELECTRIQUE



- TR**
- Paslanmaz çelik gövde ve şase
  - Termostatik kontrol
  - Yüksek verimli elektrikli ısıtma sistemi
  - Kullanıcı tarafından sökülebilen çift camlı kapak sistemi ile temizlik imkanı
  - Kapağın kapatılmasıyla başlayan pişirme döngüsü
  - Güvenliği sağlayan emniyet termostadı
  - Temizlik kolaylığı sunan fırın kabin tasarımı
  - Kullanıcı dostu kumanda ara yüzü
  - Aydınlatma lambalı pişirme kabini
  - İki yönlü fan sistemi ile kusursuz pişirme

- EN**
- Stainless steel chasis construction
  - Thermostatically controlled
  - Highly efficient electric heating system
  - Double-glazed removable door system allows to clean it by the user
  - Cooking cycle start at door closing
  - Safety thermostat provides security
  - Interior design provides ease of cleaning
  - User-friendly command interface
  - Cooking cabinet with lighting lamb
  - Perfect cooking with clockwise-anticlockwise fan system
  - Water connection allows to cooking foods with humidity (optional)

- FR**
- Construction de châssis en acier inoxydable
  - Contrôlé par thermostat
  - Système de chauffage électrique très efficace
  - Le système de porte amovible à double vitrage permet son nettoyage par l'utilisateur
  - Début du cycle de cuisson à la fermeture de la porte
  - Le thermostat de sécurité assure la sécurité
  - La conception intérieure facilite le nettoyage
  - Interface de commande conviviale
  - Meuble de cuisson avec éclairage agneau
  - Cuisson parfaite avec système de ventilation dans le sens des aiguilles d'une montre et dans le sens inverse des aiguilles d'une montre



GAST-PF3



**ELEKTRİKLİ PATİSSERİ FIRINI / ELECTRIC PASTE OVEN**



- TR**
- Paslanmaz çelik gövde ve şase
  - Termostatik kontrol
  - Yüksek verimli elektrikli ısıtma sistemi
  - Kullanıcı tarafından sökülebilen çift camlı kapak sistemi ile temizlik imkanı
  - Kapağın kapatılmasıyla başlayan pişirme döngüsü
  - Güvenliği sağlayan emniyet termostadı
  - Temizlik kolaylığı sunan fırın kabin tasarımı
  - Kullanıcı dostu kumanda ara yüzü
  - Aydınlatma lambalı pişirme kabini
  - İki yönlü fan sistemi ile kusursuz pişirme

- EN**
- Stainless steel chasis construction
  - Thermostatically controlled
  - Highly efficient electric heating system
  - Double-glazed removable door system allows to clean it by the user
  - Cooking cycle start at door closing
  - Safety thermostat provides security
  - Interior design provides ease of cleaning
  - User-friendly command interface
  - Cooking cabinet with lighting lamb
  - Perfect cooking with clockwise-anticlockwise fan system
  - Water connection allows to cooking foods with humidity (optional)

- FR**
- Construction de châssis en acier inoxydable
  - Contrôlé par thermostat
  - Système de chauffage électrique très efficace
  - Le système de porte amovible à double vitrage permet son nettoyage par l'utilisateur
  - Début du cycle de cuisson à la fermeture de la porte
  - Le thermostat de sécurité assure la sécurité
  - La conception intérieure facilite le nettoyage
  - Interface de commande conviviale
  - Meuble de cuisson avec éclairage agneau
  - Cuisson parfaite avec système de ventilation dans le sens des aiguilles d'une montre et dans le sens inverse des aiguilles d'une montre



**GAST-PF10**



**PIZZA FIRINLARI**  
PIZZA OVENS  
Four a Pizza



## ELEKTRİKLİ PİZZA FIRINI / ELECTRIC PIZZA OVENUR A PIZZA ELECTRQUE



- TR**
- Oluşan buharın atılması için havalandırma delikli
  - Fırının tamamı 6 cm kalınlığında kaya yünü izolasyonlu
  - Ön yüz komple paslanmaz çelikten, gövde fırın boyalı
  - 50° - 450° C arası termostatlı ısı kontrolü, EGO marka termostat
  - İç aydınlatma lambalı
  - 400 V üç fazlı ve 230 V tek fazlı elektrik sistemi
  - Termometreli PBT ve termometresiz PB modeller
  - Ön kapakta geniş ısıya dayanıklı cam pencere
  - 20 mm kalınlığında refraktör pişirme taşı
  - Ön kapaklarda kuvvetli yay mekanizması
  - Bağımsız kat kontrolü

- EN**
- Optimal cooking with ventilation hole
  - All surfaces are insulated by 6 cm thickness of rock wool
  - Stainless steel heating elements
  - Temperature control between 50°C–450°C is provided by EGO brand thermostat
  - Interior lighting
  - 230 V single phase / 400 V three phase are optional
  - PB-T models with thermometer and PB models without thermometer
  - Extra large heat proof glass door
  - Refractory stone thickness: 20 mm
  - Spring mechanism on doors
  - Separate control for each deck

- FR**
- Cuisson optimale avec trou de ventilation
  - Toutes les surfaces sont isolées par 6 cm d'épaisseur de laine de roche
  - Éléments chauffants en acier inoxydable
  - Le contrôle de la température entre 50°C et 450°C est assuré par le thermostat de marque EGO - L'éclairage intérieur
  - 230 V monophasé / 400 V triphasé en option
  - Modèles PB-T avec thermomètre et modèles PB sans thermomètre
  - Très grande porte en verre résistant à la chaleur
  - Epaisseur de pierre réfractaire: 20 mm
  - Mécanisme à ressort sur les portes
  - Contrôle séparé pour chaque étage



GAST-P510



GAST-PC510

## ELEKTRİKLİ PİZZA FIRINI / ELECTRIC PIZZA OVENUR A PIZZA ELECTRQUE



- TR**
- Oluşan buharın atılması için havalandırma delikli
  - Fırının tamamı 6 cm kalınlığında kaya yünü izolasyonlu
  - Ön yüz komple paslanmaz çelikten, gövde fırın boyalı
  - 50° - 450° C arası termostatlı ısı kontrolü, EGO marka termostat
  - İç aydınlatma lambalı
  - 400 V üç fazlı ve 230 V tek fazlı elektrik sistemi
  - Termometreli PBT ve termometresiz PB modeller
  - Ön kapakta geniş ısıya dayanıklı cam pencere
  - 20 mm kalınlığında refraktör pişirme taşı
  - Ön kapaklarda kuvvetli yay mekanizması
  - Bağımsız kat kontrolü

- EN**
- Optimal cooking with ventilation hole
  - All surfaces are insulated by 6 cm thickness of rock wool
  - Stainless steel heating elements
  - Temperature control between 50°C–450°C is provided by EGO brand thermostat
  - Interior lighting
  - 230 V single phase / 400 V three phase are optional
  - PB-T models with thermometer and PB models without thermometer
  - Extra large heat proof glass door
  - Refractory stone thickness: 20 mm
  - Spring mechanism on doors
  - Separate control for each deck

- FR**
- Cuisson optimale avec trou de ventilation
  - Toutes les surfaces sont isolées par 6 cm d'épaisseur de laine de roche
  - Éléments chauffants en acier inoxydable
  - Le contrôle de la température entre 50°C et 450°C est assuré par le thermostat de marque EGO - L'éclairage intérieur
  - 230 V monophasé / 400 V triphasé en option
  - Modèles PB-T avec thermomètre et modèles PB sans thermomètre
  - Très grande porte en verre résistant à la chaleur
  - Epaisseur de pierre réfractaire: 20 mm
  - Mécanisme à ressort sur les portes
  - Contrôle séparé pour chaque étage



**GAST-PC920**



**GAST-P920**



**SOĞUK ÜNİTELER**  
COLD UNITS  
Unités Froides







CAM KAPI  
GLASS DOOR



ÇEKMECE  
DRAWER

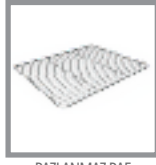

PAZLANMAZ RAF  
S.S. SHELF



TABLA SEÇENEKLERİ  
KIND OF TOPS



KİLİT  
LOCK

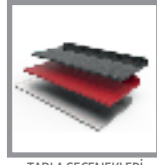

TEKERLEK  
WHEEL



TR

- Dış ortam sıcaklığı +43°C %65 nem oranı
- Eşit sıcaklık dağılımı için yeni tasarım
- Sıfır ODP enjekte 42 kg/m3 çevre dostu poliüretan izolasyon
- Elektrikli otomatik defrost
- Kolay okunur ekranlı dijital kontrol
- Ergonomik kapı ve kulpu sayesinde kolay açılma ve temizlik
- Patentli 'Icecool' soğutma sistemi ile mükemmel verim ve enerji sarfiyatı
- Sıcak gaz defrost sistemi
- Atık ısı geri kazanımlı kondanzasyon
- Tüm buzdolapların marine versiyonları mevcuttur.
- Marine versiyonları 'Icecool marine' sistemi, marine ayak ve raflar içerir.

EN

- Outdoor temperature +43°C 65% humidity
- New design for even temperature distribution
- Zero ODP injected 42 kg/m3 environmentally friendly polyurethane insulation
- Electric automatic defrost
- Digital control with easy-to-read display
- Easy opening and cleaning thanks to ergonomic door and handle
- Excellent efficiency and energy consumption with patented 'Icecool' cooling system
- Hot gas defrosting system
- Condensation with waste heat recovery
- All refrigerators are available in marine versions.
- Marine versions include the 'Icecool marine' system, marine feet and shelves.

# SOĞUK ÜNİTELER / COLD UNITS

## TEZGAH TİPİ BUZDOLAPLARI / COUNTER REFRIGERATORS

### TEZGAH TİPİ BUZDOLABI / REFRIGERATORS COUNTER WITH



1/2 Çekmece  
1/2 Drawers



1/3 Çekmece  
1/3 Drawers



Dolap Kilidi  
Cabinet Lock

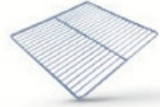

Raf ve Raf Kızağı  
Shelf and Shelf Holder



Sol Motor  
Left Motor



Tekerlekli  
Wheels



Cam Kapı  
Glass Door

Granit Üst Tabla  
Granite Work Top

Kapı  
Door

Fiyat  
Price

2  
3  
4



Polietilen Üst Tabla  
Polyethylene Work Top

Kapı  
Door

Fiyat  
Price

2  
3  
4



Mermer Üst Tabla  
Marble Work Top

Kapı  
Door

Fiyat  
Price

2  
3  
4



Üst Tablasız  
Without Table Top

Kapı  
Door

P.kalite  
S.S Quality

Fiyat  
Price



# SOĞUK ÜNİTELER / COLD UNITS / UNITÉS FROIDES TEZGAH TİPİ BUZDOLAPLARI / COUNTER REFRIGERATORS

TEZGAH TİPİ BUZDOLABI CAM KAPILI / REFRIGERATORS COUNTER WITH GLASS DOOR



CAM KAPI  
GLASS DOOR



ÇEKMECE  
DRAWER



PAZLANMAZ RAF  
S.S. SHELF



TABLA SEÇENEKLERİ  
KIND OF TOPS



KİLİT  
LOCK

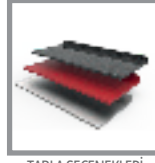

TEKERLEK  
WHEEL



TR

- Dış ortam sıcaklığı +43°C %65 nem oranı
- Eşit sıcaklık dağılımı için yeni tasarım
- Sıfır ODP enjekte 42 kg/m3 çevre dostu poliüretan izolasyon
- Elektrikli otomatik defrost
- Kolay okunur ekranlı dijital kontrol
- Ergonomik kapı ve kulpu sayesinde kolay açılma ve temizlik
- Patentli 'Icecool' soğutma sistemi ile mükemmel verim ve enerji sarfiyatı
- Sıcak gaz defrost sistemi
- Atık ısı geri kazanımlı kondanzasyon
- Tüm buzdolapların marine versiyonları mevcuttur.
- Marine versiyonları 'Icecool marine' sistemi, marine ayak ve raflar içerir.

EN

- Outdoor temperature +43°C 65% humidity
- New design for even temperature distribution
- Zero ODP injected 42 kg/m3 environmentally friendly polyurethane insulation
- Electric automatic defrost
- Digital control with easy-to-read display
- Easy opening and cleaning thanks to ergonomic door and handle
- Excellent efficiency and energy consumption with patented 'Icecool' cooling system
- Hot gas defrosting system
- Condensation with waste heat recovery
- All refrigerators are available in marine versions.
- Marine versions include the 'Icecool marine' system, marine feet and shelves.

## SOĞUK ÜNİTELER / COLD UNITS

### TEZGAH TİPİ BUZDOLAPLARI / COUNTER REFRIGERATORS



1/2 Çekmece  
1/2 Drawers



1/3 Çekmece  
1/3 Drawers



Dolap Kilidi  
Cabinet Lock



Raf ve Raf Kızağı  
Shelf and Shelf Holder



Sol Motor  
Left Motor



Tekerlekli  
Wheels



Cam Kapı  
Glass Door

Granit Üst Tabla  
Granite Work Top



Kapı  
Door

2  
3  
4

Fiyat  
Price

Polietilen Üst Tabla  
Polyethylene Work Top



Kapı  
Door

2  
3  
4

Fiyat  
Price

Mermer Üst Tabla  
Marble Work Top



Kapı  
Door

2  
3  
4

Fiyat  
Price

Üst Tablasız  
Without Table Top



EVYELİ TEZGAH TİPİ BUZDOLABI / REFRIGERATORS COUNTER WITH SINK /



CAM KAPI  
GLASS DOOR



ÇEKMECE  
DRAWER



PAZLANMAZ RAF  
S.S. SHELF



TABLA SEÇENEKLERİ  
KIND OF TOPS



KİLİT  
LOCK

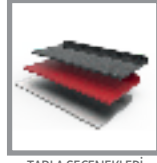

TEKERLEK  
WHEEL



TR

- Dış ortam sıcaklığı +43°C %65 nem oranı
- Eşit sıcaklık dağılımı için yeni tasarım
- Sıfır ODP enjekte 42 kg/m<sup>3</sup> çevre dostu poliüretan izolasyon-
- Elektrikli otomatik defrost
- Kolay okunur ekranlı dijital kontrol
- Ergonomik kapı ve kulpu sayesinde kolay açılma ve temizlik
- Patentli 'Icecool' soğutma sistemi ile mükemmel verim ve enerji sarfiyatı
- Sıcak gaz defrost sistemi
- Atık ısı geri kazanımlı kondansasyon
- Tüm buzdolapların marine versiyonları mevcuttur.
- Marine versiyonları 'Icecool marine' sistemi, marine ayak ve raflar içerir.

EN

- Outdoor temperature +43°C 65% humidity
- New design for even temperature distribution
- Zero ODP injected 42 kg/m<sup>3</sup> environmentally friendly polyurethane insulation
- Electric automatic defrost
- Digital control with easy-to-read display
- Easy opening and cleaning thanks to ergonomic door and handle
- Excellent efficiency and energy consumption with patented 'Icecool' cooling system
- Hot gas defrosting system
- Condensation with waste heat recovery
- All refrigerators are available in marine versions.
- Marine versions include the 'Icecool marine' system, marine feet and shelves.



**SOĞUK ÜNİTELER / COLD UNITS / UNITÉS FROIDES**  
**EVYELİ TEZGAH TİPİ BUZDOLABI / REFRIGERATORS COUNTER WITH SINK /**  
**EVYELİ TEZGAH TİPİ BUZDOLABI / REFRIGERATORS COUNTER WITH SINK**



1/2 Çekmece  
1/2 Drawers



1/3 Çekmece  
1/3 Drawers



Dolap Kilidi  
Cabinet Lock

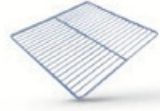

Raf ve Raf Kızağı  
Shelf and Shelf Holder



Sol Motor  
Left Motor



Tekerlekli  
Wheels



Cam Kapı  
Glass Door



# SOĞUK ÜNİTELER / COLD UNITS / CİHAZ ALTI BUZDOLAPLARI / UNDERCOUNTER REFRIGERATORS

## CİHAZ ALTI BUZDOLAPLARI / UNDERCOUNTER REFRIGERATORS /



CAM KAPI  
GLASS DOOR



ÇEKMECE  
DRAWER

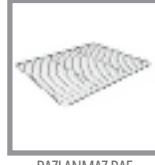

PAZLANMAZ RAF  
S.S. SHELF



TABLA SEÇENEKLERİ  
KIND OF TOPS



KİLİT  
LOCK

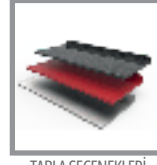

TEKERLEK  
WHEEL



TR

- Dış ortam sıcaklığı +43°C %65 nem oranı
- Eşit sıcaklık dağılımı için yeni tasarım
- Sıfır ODP enjekte 42 kg/m3 çevre dostu poliüretan izolasyon
- Elektrikli otomatik defrost
- Kolay okunur ekranlı dijital kontrol
- Ergonomik kapı ve kulpu sayesinde kolay açılma ve temizlik
- Patentli 'Icecool' soğutma sistemi ile mükemmel verim ve enerji sarfiyatı
- Sıcak gaz defrost sistemi
- Atık ısı geri kazanımlı kondansasyon
- Tüm buzdolapların marine versiyonları mevcuttur.
- Marine versiyonları 'Icecool marine' sistemi, marine ayak ve raflar içerir.

EN

- Outdoor temperature +43°C 65% humidity
- New design for even temperature distribution
- Zero ODP injected 42 kg/m3 environmentally friendly polyurethane insulation
- Electric automatic defrost
- Digital control with easy-to-read display
- Easy opening and cleaning thanks to ergonomic door and handle
- Excellent efficiency and energy consumption with patented 'Icecool' cooling system
- Hot gas defrosting system
- Condensation with waste heat recovery
- All refrigerators are available in marine versions.
- Marine versions include the 'Icecool marine' system, marine feet and shelves.

## SOĞUK ÜNİTELER / COLD UNITS / CİHAZ ALTI BUZDOLAPLARI / UNDERCOUNTER REFRIGERATORS

### CİHAZ ALTI BUZDOLAPLARI / UNDERCOUNTER REFRIGERATORS



1/2 Çekmece  
1/2 Drawers



1/1 Çekmece  
1/1 Drawers



Dolap Kilidi  
Cabinet Lock



Raf ve Raf Kızağı  
Shelf and Shelf Holder



Sol Motor  
Left Motor



Tekerlekli  
Wheels



Cam Kapı  
Glass Door

Üst Tablasız  
Without Table Top



# SOĞUK ÜNİTELER / COLD UNITS CİHAZ ALTI BUZDOLAPLARI / UNDERCOUNTER REFRIGERATORS

## CİHAZ ALTI BUZDOLABI KISA / UNDERCOUNTER REFRIGERATORS WITH SHORT



CAM KAPI  
GLASS DOOR



ÇEKMECE  
DRAWER



PAZLANMAZ RAF  
S.S. SHELF



TABLA SEÇENEKLERİ  
KIND OF TOPS



KİLİT  
LOCK

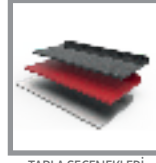

TEKERLEK  
WHEEL



TR

- Dış ortam sıcaklığı +43°C %65 nem oranı
- Eşit sıcaklık dağılımı için yeni tasarım
- Sıfır ODP enjekte 42 kg/m<sup>3</sup> çevre dostu poliüretan izolasyon
- Elektrikli otomatik defrost
- Kolay okunur ekranlı dijital kontrol
- Ergonomik kapı ve kulpu sayesinde kolay açılma ve temizlik
- Patentli 'Icecool' soğutma sistemi ile mükemmel verim ve enerji sarfiyatı
- Sıcak gaz defrost sistemi
- Atık ısı geri kazanımlı kondansasyon
- Tüm buzdolapların marine versiyonları mevcuttur.
- Marine versiyonları 'Icecool marine' sistemi, marine ayak ve raflar içerir.

EN

- Outdoor temperature +43°C 65% humidity
- New design for even temperature distribution
- Zero ODP injected 42 kg/m<sup>3</sup> environmentally friendly polyurethane insulation
- Electric automatic defrost
- Digital control with easy-to-read display
- Easy opening and cleaning thanks to ergonomic door and handle
- Excellent efficiency and energy consumption with patented 'Icecool' cooling system
- Hot gas defrosting system
- Condensation with waste heat recovery
- All refrigerators are available in marine versions.
- Marine versions include the 'Icecool marine' system, marine feet and shelves.

# SOĞUK ÜNİTELER / COLD UNITS / UNITÉS FROIDES CİHAZ ALTI BUZDOLABI KISA / UNDERCOUNTER REFRIGERATORS WITH SHORT

CİHAZ ALTI BUZDOLABI KISA / UNDERCOUNTER REFRIGERATORS WITH SHORT



1/2 Çekmece  
1/2 Drawers



1 Çekmece  
1 Drawers



Dolap Kilidi  
Cabinet Lock

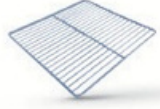

Raf ve Raf Kızağı  
Shelf and Shelf Holder



Sol Motor  
Left Motor



Tekerlekli  
Wheels



Cam Kapı  
Glass Door

Üst Tablasız  
Without Table Top





# SOĞUK ÜNİTELER / COLD UNITS / UNITÉS FROIDES

## DİK TİP BUZDOLABI TEK KAPILI / VERTICAL REFRIGERATOR WITH 1 GLASS DOOR

### DİK TİP BUZDOLABI TEK KAPILI / VERTICAL REFRIGERATOR WITH 1 GLASS DOOR



Dolap Kilidi  
Cabinet Lock

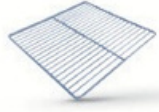

Raf ve Raf Kızağı  
Shelf and Shelf Holder



Sol Kapı  
Left Door



Tekerlekli  
Wheels



Yarım Kapı  
Half Door

#### TR

- Dış ortam sıcaklığı +43°C %65 nem oranı
- Eşit sıcaklık dağılımı için yeni tasarım
- Sıfır ODP enjekte 42 kg/m3 çevre dostu poliüretan izolasyon
- Elektrikli otomatik defrost
- Kolay okunur ekranlı dijital kontrol
- Ergonomik kapı ve kulpu sayesinde kolay açılma ve temizlik
- Patentli 'Icecool' soğutma sistemi ile mükemmel verim ve enerji sarfiyatı
- Sıcak gaz defrost sistemi
- Atık ısı geri kazanımlı kondansasyon
- Tüm buzdolapların marine versiyonları mevcuttur.
- Marine versiyonları 'Icecool marine' sistemi, marine ayak ve raflar içerir.

#### EN

- Outdoor temperature +43°C 65% humidity
- New design for even temperature distribution
- Zero ODP injected 42 kg/m3 environmentally friendly polyurethane insulation
- Electric automatic defrost
- Digital control with easy-to-read display
- Easy opening and cleaning thanks to ergonomic door and handle
- Excellent efficiency and energy consumption with patented 'Icecool' cooling system
- Hot gas defrosting system
- Condensation with waste heat recovery
- All refrigerators are available in marine versions.
- Marine versions include the 'Icecool marine' system, marine feet and shelves.



COLD UNITS

# SOĞUK ÜNİTELER / COLD UNITS / UNITÉS FROIDES DİK TİP BUZDOLABI TEK KAPILI / VERTICAL REFRIGERATOR WITH 1 GLASS DOOR

## DİK TİP BUZDOLABI TEK CAM KAPILI / VERTICAL REFRIGERATOR WITH 1GLASS DOOR



Dolap Kilidi  
Cabinet Lock

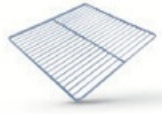

Raf ve Raf Kızağı  
Shelf and Shelf Holder



Sol Kapı  
Left Door



Tekerlekli  
Wheels



Yarım Kapı  
Half Door

### TR

- Dış ortam sıcaklığı +43°C %65 nem oranı
- Eşit sıcaklık dağılımı için yeni tasarım
- Sıfır ODP enjekte 42 kg/m<sup>3</sup> çevre dostu poliüretan izolasyon
- Elektrikli otomatik defrost
- Kolay okunur ekranlı dijital kontrol
- Ergonomik kapı ve kulpu sayesinde kolay açılma ve temizlik
- Patentli 'Icecool' soğutma sistemi ile mükemmel verim ve enerji sarfiyatı
- Sıcak gaz defrost sistemi
- Atık ısı geri kazanımlı kondanzasyon
- Tüm buzdolapların marine versiyonları mevcuttur.
- Marine versiyonları 'Icecool marine' sistemi, marine ayak ve raflar içerir.

### EN

- Outdoor temperature +43°C 65% humidity
- New design for even temperature distribution
- Zero ODP injected 42 kg/m<sup>3</sup> environmentally friendly polyurethane insulation
- Electric automatic defrost
- Digital control with easy-to-read display
- Easy opening and cleaning thanks to ergonomic door and handle
- Excellent efficiency and energy consumption with patented 'Icecool' cooling system
- Hot gas defrosting system
- Condensation with waste heat recovery
- All refrigerators are available in marine versions.
- Marine versions include the 'Icecool marine' system, marine feet and shelves.



# SOĞUK ÜNİTELER / COLD UNITS / UNITÉS FROIDES MAKE UP BUZDOLAPLARI / MAKE UP REFRIGERATORS

DİK TİP BUZDOLABI ÇİFT KAPILI / VERTICAL REFRIGERATOR WITH 2 GLASS DOOR



Dolap Kilidi  
Cabinet Lock

75 €

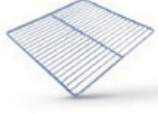

Raf ve Raf Kızağı  
Shelf and Shelf Holder

55 €



Tekerlekli  
Wheels

95 €



Yarım Kapı  
Half Door

225 €

TR

- Dış ortam sıcaklığı +43°C %65 nem oranı
- Eşit sıcaklık dağılımı için yeni tasarım
- Sıfır ODP enjekte 42 kg/m3 çevre dostu poliüretan izolasyon
- Elektrikli otomatik defrost
- Kolay okunur ekranlı dijital kontrol
- Ergonomik kapı ve kulpu sayesinde kolay açılma ve temizlik
- Patentli 'Icecool' soğutma sistemi ile mükemmel verim ve enerji sarfiyatı
- Sıcak gaz defrost sistemi
- Atık ısı geri kazanımlı kondansasyon
- Tüm buzdolapların marine versiyonları mevcuttur.
- Marine versiyonları 'Icecool marine' sistemi, marine ayak ve raflar içerir.

EN

- Outdoor temperature +43°C 65% humidity
- New design for even temperature distribution
- Zero ODP injected 42 kg/m3 environmentally friendly polyurethane insulation
- Electric automatic defrost
- Digital control with easy-to-read display
- Easy opening and cleaning thanks to ergonomic door and handle
- Excellent efficiency and energy consumption with patented 'Icecool' cooling system
- Hot gas defrosting system
- Condensation with waste heat recovery
- All refrigerators are available in marine versions.
- Marine versions include the 'Icecool marine' system, marine feet and shelves.



COLD UNITS

## SOĞUK ÜNİTELER / COLD UNITS MAKE UP BUZDOLAPLARI / MAKE UP REFRIGERATORS

### DİK TİP BUZDOLABI ÇİFT KAPILI / VERTICAL REFRIGERATOR WITH 2 GLASS DOOR



Dolap Kilidi  
Cabinet Lock

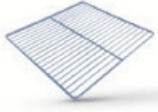

Raf ve Raf Kızağı  
Shelf and Shelf Holder



Tekerlekli  
Wheels



Yarım Kapı  
Half Door

#### TR

- Dış ortam sıcaklığı +43°C %65 nem oranı
- Eşit sıcaklık dağılımı için yeni tasarım
- Sıfır ODP enjekte 42 kg/m3 çevre dostu poliüretan izolasyon- Elektrikli otomatik defrost
- Kolay okunur ekranlı dijital kontrol
- Ergonomik kapı ve kulpu sayesinde kolay açılma ve temizlik
- Patentli 'Icecool' soğutma sistemi ile mükemmel verim ve enerji sarfiyatı
- Sıcak gaz defrost sistemi
- Atık ısı geri kazanımlı kondansasyon
- Tüm buzdolapların marine versiyonları mevcuttur.
- Marine versiyonları 'Icecool marine' sistemi, marine ayak ve raflar içerir.

#### EN

- Outdoor temperature +43°C 65% humidity
- New design for even temperature distribution
- Zero ODP injected 42 kg/m3 environmentally friendly polyurethane insulation
- Electric automatic defrost
- Digital control with easy-to-read display
- Easy opening and cleaning thanks to ergonomic door and handle
- Excellent efficiency and energy consumption with patented 'Icecool' cooling system
- Hot gas defrosting system
- Condensation with waste heat recovery
- All refrigerators are available in marine versions.
- Marine versions include the 'Icecool marine' system, marine feet and shelves.



Gastronom  
kuvetler  
fiyata dahil  
değildir.

Gastronom  
containers  
are not  
included.



TR

- Dış ortam sıcaklığı +43°C %65 nem oranı
- Eşit sıcaklık dağılımı için yeni tasarım
- Sıfır ODP enjekte 42 kg/m3 çevre dostu poliüretan izolasyon
- Elektrikli otomatik defrost
- Kolay okunur ekranlı dijital kontrol
- Ergonomik kapı ve kulpu sayesinde kolay açılma ve temizlik
- Patentli 'Icecool' soğutma sistemi ile mükemmel verim ve enerji sarfiyatı
- Sıcak gaz defrost sistemi
- Atık ısı geri kazanımlı kondansasyon
- Tüm buzdolapların marine versiyonları mevcuttur.
- Marine versiyonları 'Icecool marine' sistemi, marine ayak ve raflar içerir.

EN

- Outdoor temperature +43°C 65% humidity
- New design for even temperature distribution
- Zero ODP injected 42 kg/m3 environmentally friendly polyurethane insulation
- Electric automatic defrost
- Digital control with easy-to-read display
- Easy opening and cleaning thanks to ergonomic door and handle
- Excellent efficiency and energy consumption with patented 'Icecool' cooling system
- Hot gas defrosting system
- Condensation with waste heat recovery
- All refrigerators are available in marine versions.
- Marine versions include the 'Icecool marine' system, marine feet and shelves.



MAKE UP BUZDOLAPLARI - YÜKSEK / MAKE UP REFRIGERATORS - HIGH



1/2 Çekmece  
1/2 Drawers



1/3 Çekmece  
1/3 Drawers



Dolap Kilidi  
Cabinet Lock

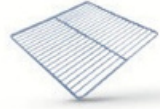

Raf ve Raf Kızağı  
Shelf and Shelf Holder



Sol Motor  
Left Motor



Tekerlekli  
Wheels



Cam Kapı  
Glass Door

**Gastronom  
küvetler  
fiyata dahil  
değildir.**

Gastronom  
containers are not  
included.



Gastronom  
küvetler  
fiyata dahil  
değildir.

Gastronom  
containers  
are not  
included.



TR

- Dış ortam sıcaklığı +43°C %65 nem oranı
- Eşit sıcaklık dağılımı için yeni tasarım
- Sıfır ODP enjekte 42 kg/m3 çevre dostu poliüretan izolasyon
- Elektrikli otomatik defrost
- Kolay okunur ekranlı dijital kontrol
- Ergonomik kapı ve kulpu sayesinde kolay açılma ve temizlik
- Patentli 'Icecool' soğutma sistemi ile mükemmel verim ve enerji sarfiyatı
- Sıcak gaz defrost sistemi
- Atık ısı geri kazanımlı kondanzasyon
- Tüm buzdolapların marine versiyonları mevcuttur.
- Marine versiyonları 'Icecool marine' sistemi, marine ayak ve raflar içerir.

EN

- Outdoor temperature +43°C 65% humidity
- New design for even temperature distribution
- Zero ODP injected 42 kg/m3 environmentally friendly polyurethane insulation
- Electric automatic defrost
- Digital control with easy-to-read display
- Easy opening and cleaning thanks to ergonomic door and handle
- Excellent efficiency and energy consumption with patented 'Icecool' cooling system
- Hot gas defrosting system
- Condensation with waste heat recovery
- All refrigerators are available in marine versions.
- Marine versions include the 'Icecool marine' system, marine feet and shelves.

# SOĞUK ÜNİTELER / COLD UNITS / UNITÉS FROIDES MAKE UP BUZDOLAPLARI / MAKE UP REFRIGERATORS

## MAKE UP BUZDOLAPLARI - KISA / MAKE UP REFRIGERATORS - SHORT



1/2 Çekmece / 1/2 Drawers



1/3 Çekmece / 1/3 Drawers



Dolap Kilidi / Cabinet Lock

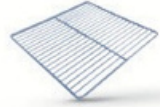

Raf ve Raf Kızağı / Shelf and Shelf Holder



Sol Motor / Left Motor



Tekerlekli Teker / Wheels



Cam Kapı / Glass Door

Granit Üst Tabla / Granite Work Top



Kapı / Door

2  
3  
4

Poliyeten Üst Tabla / Polyethylene Work Top



Kapı / Door

2  
3  
4

Mermer Üst Tabla / Marble Work Top



Kapı / Door

2  
3  
4

Üst Tablasız / Without Table Top



**Gastronom  
kuvvetler  
fiyata dahil  
değildir.**

Gastronom  
containers are not  
included.



**Gastronom küvetler  
fiyata dahil değildir.**  
Gastronom containers  
are not included.

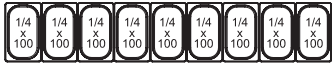
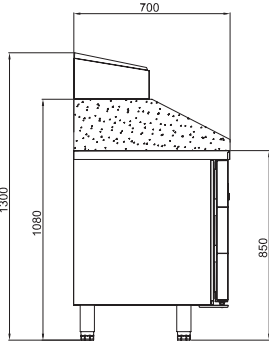
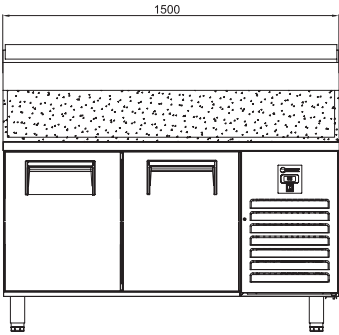

TR

- Dış ortam sıcaklığı +43°C %65 nem oranı
- Eşit sıcaklık dağılımı için yeni tasarım
- Sıfır ODP enjekte 42 kg/m3 çevre dostu poliüretan izolasyon
- Elektrikli otomatik defrost
- Kolay okunur ekranlı dijital kontrol
- Ergonomik kapı ve kulpu sayesinde kolay açılma ve temizlik
- Patentli 'Icecool' soğutma sistemi ile mükemmel verim ve enerji sarfiyatı
- Sıcak gaz defrost sistemi
- Atık ısı geri kazanımlı kondansasyon
- Tüm buzdolapların marine versiyonları mevcuttur.
- Marine versiyonları 'Icecool marine' sistemi, marine ayak ve raflar içerir.

EN

- Outdoor temperature +43°C 65% humidity
- New design for even temperature distribution
- Zero ODP injected 42 kg/m3 environmentally friendly polyurethane insulation
- Electric automatic defrost
- Digital control with easy-to-read display
- Easy opening and cleaning thanks to ergonomic door and handle
- Excellent efficiency and energy consumption with patented 'Icecool' cooling system
- Hot gas defrosting system
- Condensation with waste heat recovery
- All refrigerators are available in marine versions.
- Marine versions include the 'Icecool marine' system, marine feet and shelves.

## SOĞUK ÜNİTELER / COLD UNITS MAKE UP BUZDOLAPLARI / MAKE UP REFRIGERATORS

### MAKE UP BUZDOLAPLARI - MERMERLİ / MAKE UP REFRIGERATORS - MARBLE



1/2 Çekmece / 1/2 Drawers



1/3 Çekmece / 1/3 Drawers



Dolap Kilidi / Cabinet Lock

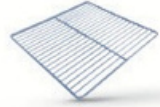

Raf ve Raf Kızağı / Shelf and Shelf Holder



Sol Motor / Left Motor



Tekerlekli / Wheels



Cam Kapı / Glass Door



**Gastronom  
küvetler  
fiyata dahil  
değildir.**

Gastronom  
containers are not  
included.





MAKE UP BUZDOLAPLARI - MERMERLİ / MAKE UP REFRIGERATORS - MARBLE

Gastronom  
küvetler  
fiyata dahil  
değildir.

Gastronom  
containers are not  
included.

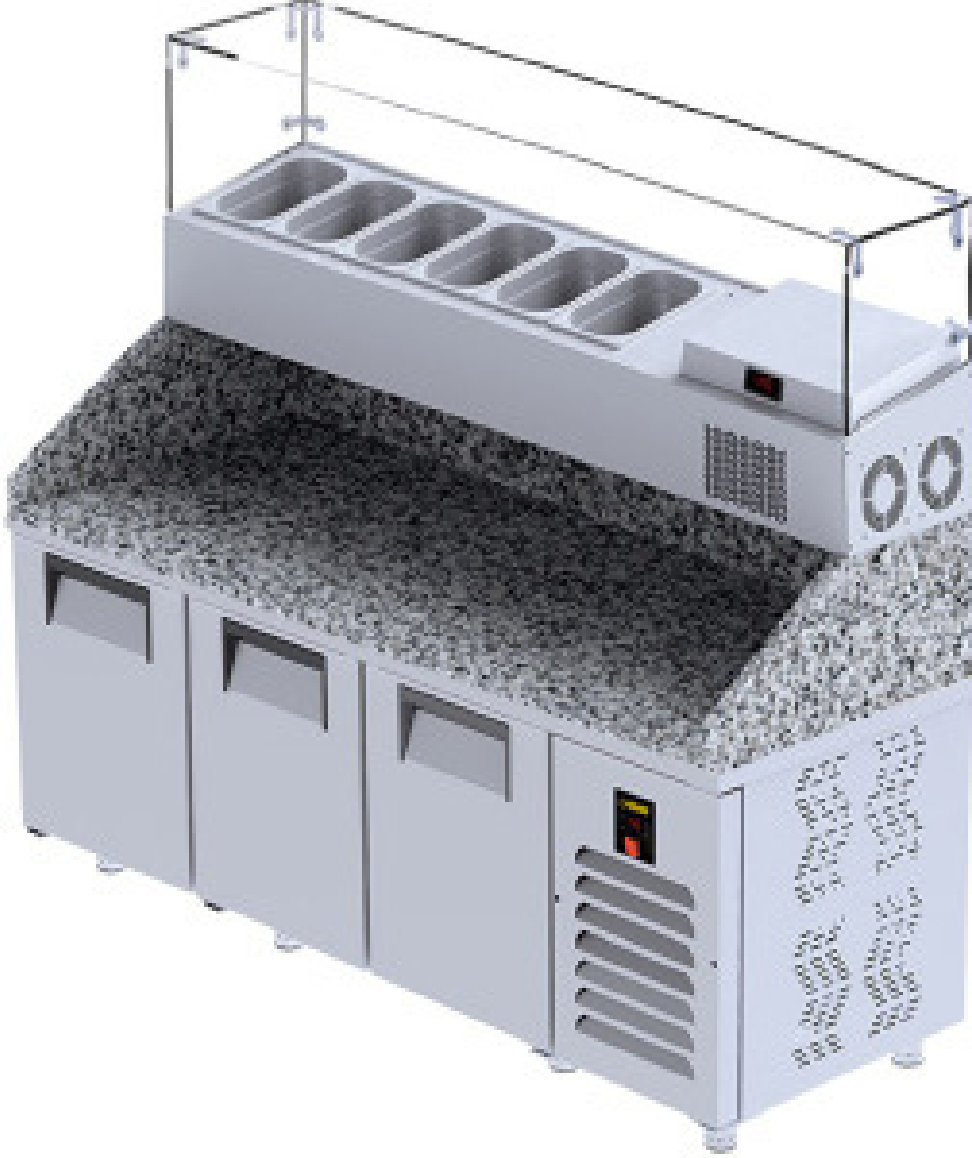

TR

- Dış ortam sıcaklığı +43°C %65 nem oranı
- Eşit sıcaklık dağılımı için yeni tasarım
- Sıfır ODP enjekte 42 kg/m3 çevre dostu poliüretan izolasyon
- Elektrikli otomatik defrost
- Kolay okunur ekranlı dijital kontrol
- Ergonomik kapı ve kulpu sayesinde kolay açılma ve temizlik
- Patentli 'Icecool' soğutma sistemi ile mükemmel verim ve enerji sarfiyatı
- Sıcak gaz defrost sistemi
- Atık ısı geri kazanımlı kondanzasyon
- Tüm buzdolapların marine versiyonları mevcuttur.
- Marine versiyonları 'Icecool marine' sistemi, marine ayak ve raflar içerir.

EN

- Outdoor temperature +43°C 65% humidity
- New design for even temperature distribution
- Zero ODP injected 42 kg/m3 environmentally friendly polyurethane insulation
- Electric automatic defrost
- Digital control with easy-to-read display
- Easy opening and cleaning thanks to ergonomic door and handle
- Excellent efficiency and energy consumption with patented 'Icecool' cooling system
- Hot gas defrosting system
- Condensation with waste heat recovery
- All refrigerators are available in marine versions.
- Marine versions include the 'Icecool marine' system, marine feet and shelves.

# SOĞUK ÜNİTELER / COLD UNITS / UNITÉS FROIDES MAKE UP BUZDOLAPLARI / MAKE UP REFRIGERATORS

MAKE UP BUZDOLAPLARI 40X60 TEPŞİ KAPASİTELİ/ MAKE UP REFRIGERATORS W/40X60 TRAY CAPACITY



1/2 Çekmece  
1/2 Drawers



1/3 Çekmece  
1/3 Drawers



Dolap Kilidi  
Cabinet Lock

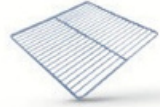

Raf ve Raf Kızağı  
Shelf and Shelf Holder



Sol Motor  
Left Motor



Tekerlekli  
Wheels



Cam Kapı  
Glass Door

**Gastronom  
küvetler  
fiyata dahil  
değildir.**

Gastronom  
containers are not  
included.

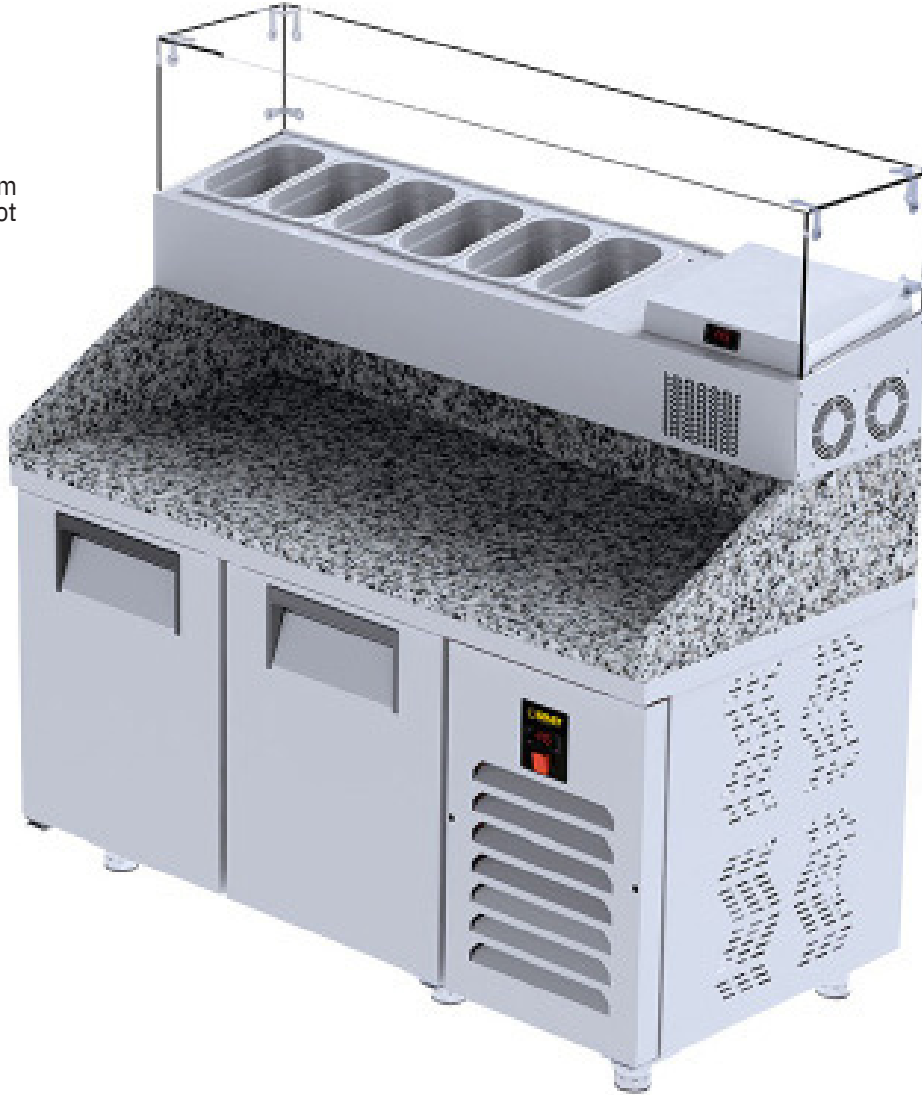

# SOĞUK ÜNİTELER / COLD UNITS / UNITÉS FROIDES SET ÜSTÜ SALADBARLAR / COUNTERTOP SALADBARS

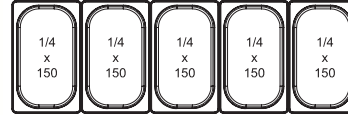
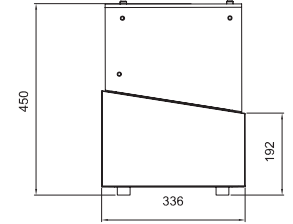
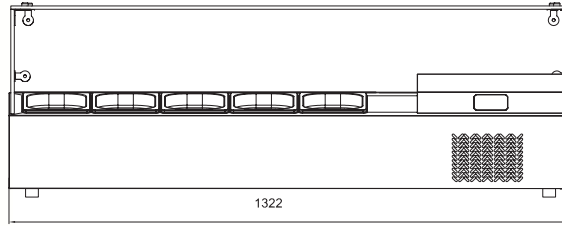
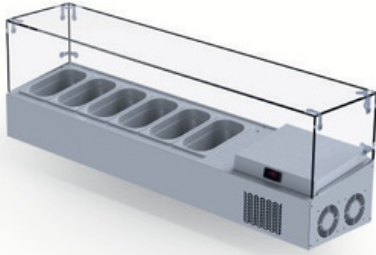
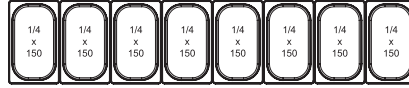
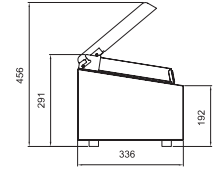
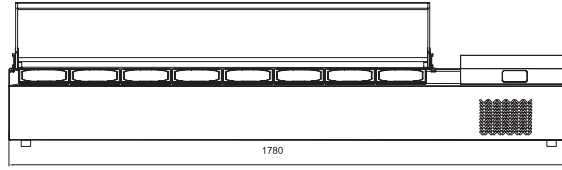

TR

- Dış ortam sıcaklığı +43°C %65 nem oranı
- Eşit sıcaklık dağılımı için yeni tasarım
- Sıfır ODP enjekte 42 kg/m<sup>3</sup> çevre dostu poliüretan izolasyon
- Elektrikli otomatik defrost
- Kolay okunur ekranlı dijital kontrol
- Ergonomik kapı ve kulpu sayesinde kolay açılma ve temizlik
- Patentli 'Icecool' soğutma sistemi ile mükemmel verim ve enerji sarfiyatı
- Sıcak gaz defrost sistemi
- Atık ısı geri kazanımlı kondansasyon
- Tüm buzdolapların marine versiyonları mevcuttur.
- Marine versiyonları 'Icecool marine' sistemi, marine ayak ve raflar içerir.

EN

- Outdoor temperature +43°C 65% humidity
- New design for even temperature distribution
- Zero ODP injected 42 kg/m<sup>3</sup> environmentally friendly polyurethane insulation - Electric automatic defrost
- Digital control with easy-to-read display
- Easy opening and cleaning thanks to ergonomic door and handle
- Excellent efficiency and energy consumption with patented 'Icecool' cooling system
- Hot gas defrosting system
- Condensation with waste heat recovery
- All refrigerators are available in marine versions.
- Marine versions include the 'Icecool marine' system, marine feet and shelves.

Gastronom  
kuvvetler  
fiyata dahil  
değildir.

Gastronom  
containers are not  
included.

COLD UNITS

**SOĞUK ÜNİTELER / COLD UNITS / UNITÉS FROIDES**  
**TEZGAH ALTI MİNİ BUZDOLAPLARI / CUNDERCOUNTER REFRIGERATORS**  
**TEZGAH ALTI MİNİ BUZDOLAPLARI / CUNDERCOUNTER REFRIGERATORS**

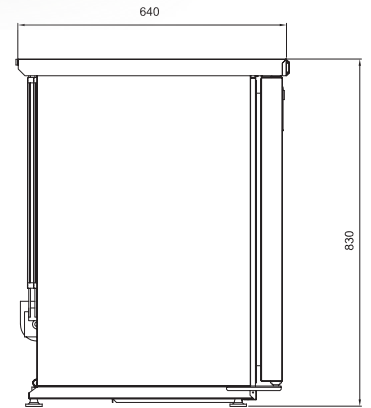
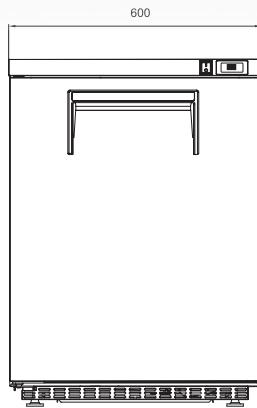

BUZ MAKİNALARI / ICE CUBE MACHINES



GAST  
ICE30



GAST  
ICE50



GAST  
ICE90



GAST-  
ICE250



GAST-  
ICE500

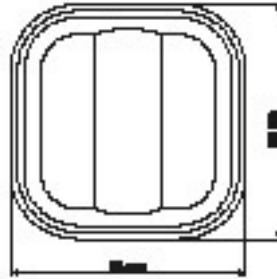
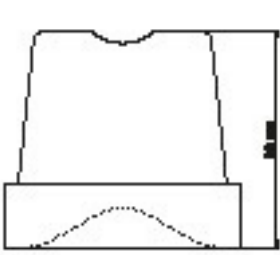
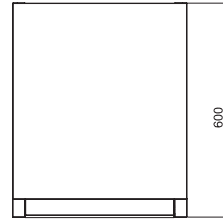
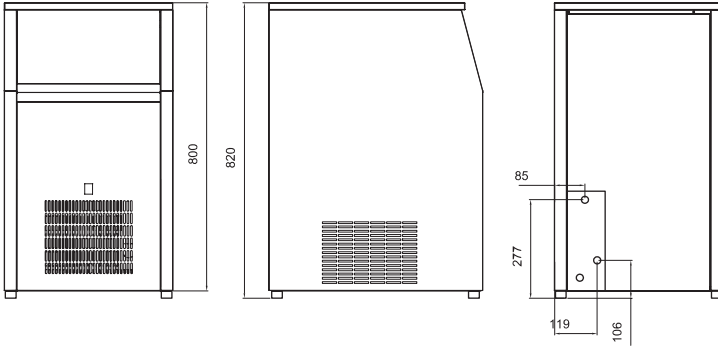

22 gr.

Daha az su tüketimi ile ayda 3 ton su tasarrufu ve daha kısa buz yapma süresi.

With less water consumption, 3 tons of water saving per month and shorter ice making time.

Yerden 28 cm yükseklikteki su gideri sayesinde ekstra pompa ihtiyacı yoktur.

There is no need for an extra water pump by the help of the 28 cm high water drain from the ground.



# İÇECEK DİSPANSERLERİ BEVERAGE DISPENSERS- Dispensaires De Boissons

# İÇECEK DİSPANSERLERİ BEVERAGE DISPANSERS / Dispansaires De Boissons

Dispansaires De Boissons

## İÇECEK DİSPANSERİ / BEVERAGE DISPANSERS/

- Kırılmaya dayanıklı polikarbon haznesi ile hijyen sağlar.
- Yeni sistem kırılmaz musluk.
- Elektromanyetik pompa/sessiz redüktör motoru.
- Paslanmaz çelik yan ve ön saçlar
- Sessiz, dayanıklı, güçlü kompresör.
- Dizaynı sayesinde kolay bakım ve temizlik sağlar
- Sarı ve paslamaz renk seçeneği.

EN

- Provides hygiene with its break-resistant polycarbonate reservoir. - New system unbreakable faucet.
- Electromagnetic pump / silent reducer motor.
- Stainless steel side and front plates
- Silent, durable, powerful compressor.
- Easy maintenance and cleaning thanks to its design
- Yellow and rust-free colour option.

FR

- Assure l'hygiène grâce à son réservoir en polycarbonate résistant à la rupture. - Nouveau système de robinetterie incassable.
- Pompe électromagnétique / moteur réducteur silencieux.
- Plaques latérales et frontales en acier inoxydable
- Compresseur silencieux, durable et puissant.
- Facilité d'entretien et de nettoyage grâce à son design
- Option de couleur jaune et anti-rouille.



GAST-ST10



GAST-ST13



GAST-ST30



GAST-ST35



GAST-ST38





**RoseBuild**

**ÇAY**  
**MAKİNELERİ TEA**  
**MACHINES**  
Machines A Thes





## ÇAY MAKİNALARI

TEA MACHINES /Machines A The

### ÇAY OCAKLARI / TEA KITCHENS /

- Paslanmaz Çelikten veya Bakırdan Üretilmiştir.
- Yeni sistem kırılmaz musluk.
- Çay lezzetinin uzun süre bozulmamasını sağlar.
- Hijyenik ve dayanıklıdır.
- Otomatik ısı kontrol sistemi.
- Dizaynı sayesinde kolay bakım ve temizlik sağlar.
- Toplu tüketim için uygundur.

EN

- Made of Stainless Steel or Copper.
- New system unbreakable tap.
- It ensures that the tea flavour does not deteriorate for a long time. - Hygienic and durable.
- Automatic temperature control system.
- Easy maintenance and cleaning thanks to its design.
- Suitable for mass consumption.

FR

- Fabriqué en acier inoxydable ou en cuivre.
- Nouveau système de robinet incassable.
- Il garantit que l'arôme du thé ne se détériore pas pendant longtemps. - Hygiénique et durable.
- Système de contrôle automatique de la température.
- Facile à entretenir et à nettoyer grâce à sa conception.
- Convient à la consommation de masse.



GAST-APK02



GAST-BPE2



GAST-EBE2



**HAZIRLIK EKİPMANLARI**  
PREPARATION EQUIPMENTS  
Equipement De Préparation





## ET & KIYMA MAKİNALARI

MEAT & MINCING MACHINES / Machines A Hacher La Viande

### KIYMA MAKİNELERİ / MINCING MACHINES/

- Sfero döküm kafa, helezon, kafa bileziği.
- Kolay sökülebilir ve temizlenebilir.
- Paslanmaz çelik gövde sacı ve et haznesi.
- İleri-geri çalışma sistemi.
- Soğutma sistemli.
- Plastik plastik et tokmağı.

EN

- Ductile iron head, auger, head ring.
- Easy to disassemble and clean.
- Stainless steel body plate and meat chamber. - Forward-reverse working system.
- Cooling system.
- Plastic plastic meat rammer.

FR

- Tête, vis sans fin et anneau de tête en fonte ductile.
- Facile à démonter et à nettoyer.
- Plaque de corps et chambre à viande en acier inoxydable. - Système de travail avant-arrière.
- Système de refroidissement.
- Pilon à viande en plastique.



GAST-KN12



GAST-KSN022

## ET & KEMİK TESTERELERİ MEAT & BONE SAWS

TR

- Paslanmaz çelikten üretilmiştir.
- Soğutulmuş et ve kemik kesimi için uygundur.
- Hijyenik ve dayanıklıdır.
- Otomatik ısı kontrol sistemi.
- Dizaynı sayesinde kolay bakım ve temizlik sağlar.

EN

- Made of stainless steel.
- Suitable for chilled meat and bone cutting.
- Hygienic and durable.
- Automatic temperature control system.
- Easy maintenance and cleaning thanks to its design.

FR

- Fabriqué en acier inoxydable.
- Convient à la découpe de viandes et d'os réfrigérés.
- Hyg nique et durable.
- Syst me de contr le automatique de la temp rature. - Facile   entretenir et   nettoyer gr ce   sa conception.



GAST-KET01



GAST-KET02

## SOĞAN DOĞRAMA

ONION CHOPPING / Hacher Des Oignons

TR

- Paslanmaz çelikten veya bakırdan üretilmiştir.
- Keskin bıçakları sayesinde ince kesim.
- Hijyenik ve dayanıklıdır.
- Dizaynı sayesinde kolay bakım ve temizlik sağlar.
- Sökülüp takılabilen paslanmaz parçalar

EN

- Made of stainless steel or copper.
- Fine cutting with sharp blades.
- Hygienic and durable.
- Easy maintenance and cleaning thanks to its design.
- Removable stainless parts

FR

- Fabriqué en acier inoxydable ou en cuivre.
- Coupe fine grâce à ses lames tranchantes.
- Hyg nique et durable.
- Entretien et nettoyage faciles gr ce   sa conception.
- Pi ces amovibles en acier inoxydable



GAST-SOD01



GAST-SOD02

**BULAŞIK MAKİNELERİ**  
**DISWASHERS / Lave-Verre**





rosehantrade.com

# BULAŞIK MAKİNELERİ DISHWASHERS Lave - Verre



**RoseBuild**

# BULAŞIK MAKİNELERİ DISHWASHERS / Lave- Verre

TR

- Paslanmaz çelik gövde ve şase
- Yüksek kalitede paslanmaz çelik ısıtıcılar
- Aynı anda devrede olmayan ısıtma sistemi ile enerji tasarrufu
- Çift cidarlı kapak
- Dönen alt ve üst yıkama kolları
- Kapağın kapatılmasıyla başlayan yıkama döngüsü
- Otomatik dolan yıkama tankı
- Emniyet termostadı
- Manyetik kapak sivici
- Kullanıcı dostu kumanda arayüzü
- Yüksekliği ayarlanabilir ayaklar
- Parlaticı pompası dahildir
- Drenaj ve deterjan pompası bağlanabilme imkanı (opsiyonel)



GAST-BY535E

EN

- Stainless steel construction
- High quality stainless steel heaters
- Not simultaneously activated heating system provides energy saving - Double walled door
- Rotating upper and lower washing arms
- Cycle start at door closing
- Automatic tank loading
- Safety thermostat
- Magnetic door switch
- User-friendly command interface
- Height adjustable feet
- Rinse aid pump included
- Drain and detergent pump can be connected to chassis (optional)



GAST-BY640

FR

- Construction en acier inoxydable
- Chauffage en acier inoxydable de haute qualité
- Le système de chauffage non simultané permet d'économiser de l'énergie
- Porte à double paroi
- Bras de lavage supérieur et inférieur rotatifs
- Démarrage du cycle à la fermeture de la porte
- Chargement automatique de la cuve
- Thermostat de sécurité
- Interrupteur magnétique de porte
- Interface de commande conviviale
- Pieds réglables en hauteur
- Pompe de rinçage incluse
- La pompe de vidange et de détergent peut être raccordée au châssis (en option)

Drenaj pompası  
Drainage Pump



Parlaticı pompası  
Rinse Pump



Deterjan pompası  
Detergent Pump



# BULAŞIK MAKİNELERİ

## DISHWASHERS / Lave- Verre

### TR

- Paslanmaz çelik gövde ve şase
- Yüksek kalitede paslanmaz çelik ısıtıcılar
- Aynı anda devrede olmayan ısıtma sistemi ile enerji tasarrufu
- Çift cidarlı kapak
- Dönen alt ve üst yıkama kolları
- Kapağın kapatılmasıyla başlayan yıkama döngüsü
- Otomatik dolan yıkama tankı
- Emniyet termostadı
- Manyetik kapak sivici
- Kullanıcı dostu kumanda arayüzü
- Yüksekliği ayarlanabilir ayaklar
- Parlaticı pompası dahildir
- Drenaj ve deterjan pompası bağlanabilme imkanı (opsiyonel)

### EN

- Stainless steel construction
- High quality stainless steel heaters
- Not simultaneously activated heating system provides energy saving - Double walled door
- Rotating upper and lower washing arms
- Cycle start at door closing
- Automatic tank loading
- Safety thermostat
- Magnetic door switch
- User-friendly command interface
- Height adjustable feet
- Rinse aid pump included
- Drain and detergent pump can be connected to chassis (optional)

### FR

- Construction en acier inoxydable
- Chauffage en acier inoxydable de haute qualité
- Le système de chauffage non simultané permet d'économiser de l'énergie
- Porte à double paroi
- Bras de lavage supérieur et inférieur rotatifs
- Démarrage du cycle à la fermeture de la porte
- Chargement automatique de la cuve
- Thermostat de sécurité
- Interrupteur magnétique de porte
- Interface de commande conviviale
- Pieds réglables en hauteur
- Pompe de rinçage incluse
- La pompe de vidange et de détergent peut être raccordée au châssis (en option)



GAST-TY500

Drenaj pompası  
Drainage Pump



Parlaticı pompası  
Rinse Pump



Deterjan pompası  
Detergent Pump



# BULAŞIK MAKİNELERİ DISHWASHERS

- 18/10 304 AISI paslanmaz çelik gövde ve şase
- Yüksek kalitede paslanmaz çelik ısıtıcılar
- Kapağın kapatılmasıyla başlayan yıkama işlemi
- Dijital sıcaklık göstergeleri (opsiyonel)
- Çift hız kademeli konveyör sistem (opsiyonel)
- Avrupa üretimi motorlar
- Soğuk su ve sıcak su bağlantı imkanı
- Sıcak su bağlantısına dayanıklı komponentler sayesinde düşük elektrik tüketimi imkanı
- Bağımsız ön yıkama ve yıkama tankı
- Ön ısıtılmalı boiler tank sistemi
- Emniyet termostatları
- Kullanıcı dostu kumanda arayüzü
- Yüksekliği ayarlanabilir ayaklar
- Güvenlik için acil durdurma butonu
- Ön yıkama, yıkama, durulama ve kurutma aşamaları
- Entegre tank filtresi



GAST-KT2000

EN

- 18/10 AISI 304 stainless steel construction
- High quality stainless steel heaters
- Cycle start at door closing
- Digital temperature display (optional)
- Conveyor system with dual-stage speed (optional)
- Motors are made in Europe
- Cold water and hot water connection possibility
- Low electricity consumption thanks to components resistant to hot water connection
- Individual pre-wash and wash tank
- Pre-heated boiler tank system
- Safety switches
- User-friendly control interface
- Height-adjustable legs
- Emergency stop button for safety
- Prewashing, washing, rinsing and drying stages
- Rinsing boost, detergent and rinse aid pump can be connected to chassis (optional)

FR

- Construction en acier inoxydable 18/10 AISI 304
- Chauffage en acier inoxydable de haute qualité
- Démarrage du cycle à la fermeture de la porte
- Affichage numérique de la température (en option)
- Système de convoyage à double vitesse (en option)
- Les moteurs sont fabriqués en Europe
- Possibilité de raccordement à l'eau froide et à l'eau chaude
- Faible consommation d'électricité grâce à des composants résistants au raccordement à l'eau chaude
- Réservoir de pré-lavage et de lavage individuel
- Système de réservoir de chaudière préchauffé
- Interrupteurs de sécurité
- Interface de commande conviviale
- Pieds réglables en hauteur
- Bouton d'arrêt d'urgence pour la sécurité
- Étapes de pré-lavage, de lavage, de rinçage et de séchage



Parlatıcı pompası  
Rinse Pump



Deterjan pompası  
Detergent Pump



# BULAŞIK MAKİNELERİ DISHWASHERS

## 1000 TABAK BULAŞIK MAKİNESİ / DISHWASHER 1000 PLATES-HOUR

TR

- Estetik tasarım
- Paslanmaz çelikten imal edilmiş gövde
- Kolay kullanım kontrol paneli
- Özel kapak ve yay tasarımı
- 9kW boiler rezistansı ile hijyenik yıkama için 82°C'ye sabitlenmiş durulama suyu
- Her yıkamada 3litre su tüketimi
- En iyi yıkama için özel tasarlanmış yıkama ve durulama kolu
- Özel alaşımli plastik parçalar
- 3 programlı
- Kısa 60sn
- Orta 90sn
- Uzun 120sn

EN

- Esthetic design
- Stainless Steel body
- Easy usage control panel
- 3 liter water consumption for every washing
- Special designed wash and rinse spraying arm, provides the best washing
- Best washing performance with custom designed waste water discharge system
- Standard drain pump
- Low cost spare parts
- 3 programme (60sec/90sec/120sec)
- 9kw boiler heaters provides the fixed 82°C water temperature level for the best washing results.

FR

- Design esthétique
- Corps en acier inoxydable
- Panneau de contrôle d'utilisation facile
- 3 litres de consommation d'eau pour chaque lavage
- Bras de pulvérisation spécialement conçu pour le lavage et le rinçage, procurant le meilleur lavage
- Meilleure performance de lavage avec un système d'évacuation des eaux usées conçu sur mesure
- Pompe de vidange standard
- Pièces de rechange à faible coût
- 3 programmes (60sec / 90sec / 120sec)
- La résistance de la chaudière de 9 kW fournit le niveau de température d'eau fixe de 82°C pour le meilleur résultats de lavage



GAST-TBM1000

Drenaj pompası  
Drainage Pump



Parlatıcı pompası  
Rinse Pump



Deterjan pompası  
Detergent Pump



DISHWASHERS



**TEZGAHLAR**  
BENCHES  
Comptoirs



**DEMONTTE ALIŐMA TEZGAHLARI / DISMOUNTABLE WORK TABLES /**

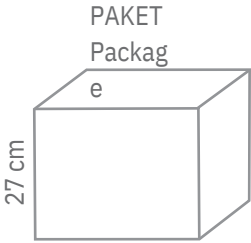

**600 mm Demonte alıŐma Tezgahı**  
600 mm Dismountable Working Tables

**DEMONTE TEK EVYELİ TEZGAH / DISMOUNTABLE WORK TABLE WITH 1 SINK**

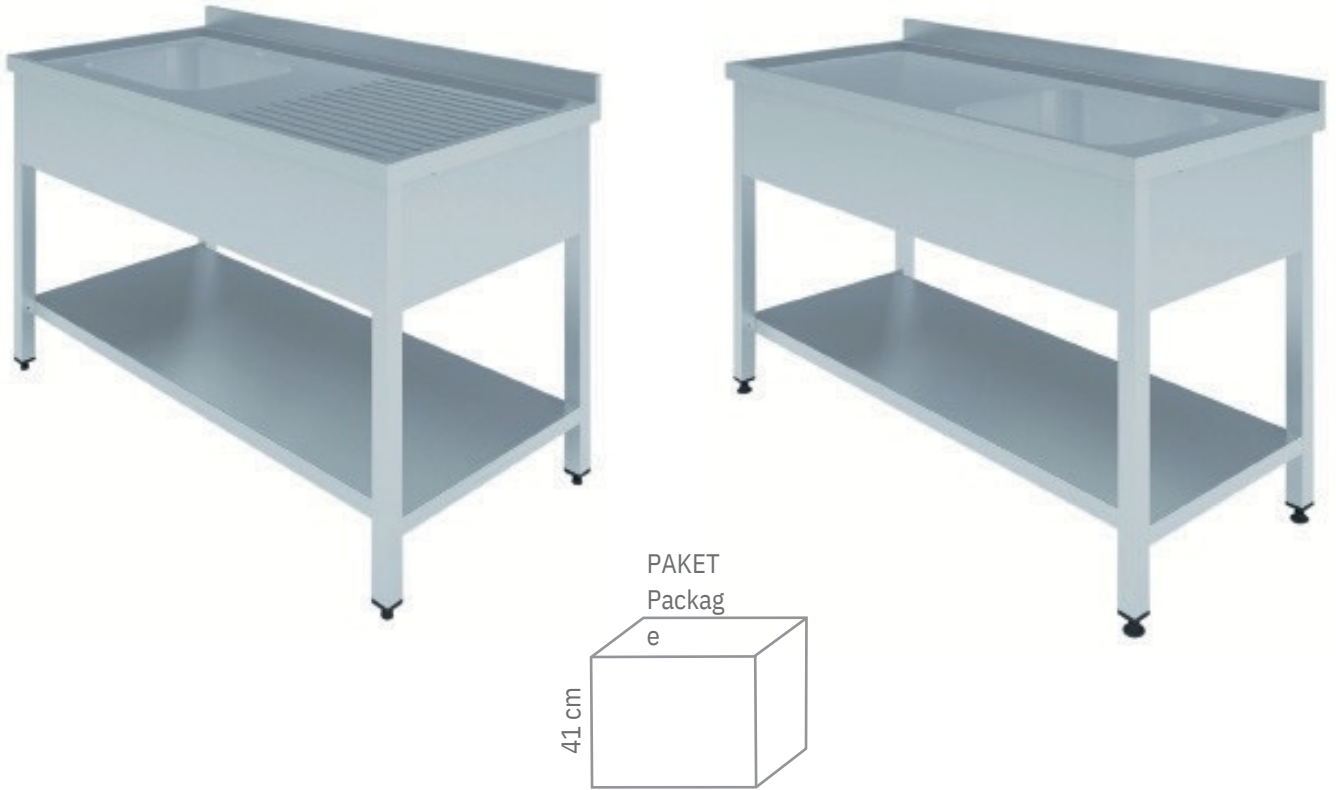

DEMONTABLE İKİ EVYELİ TEZGAH / DISMOUNTABLE WORK TABLE WITH 2 SINKS

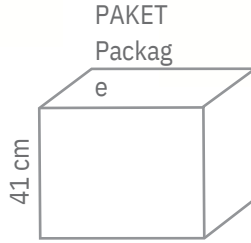

**BAR MODÜLLERİ**  
BAR MODULES / Modules de Barre



**RoseBuild**









**BAR MODÜLLERİ**  
BAR MODULES  
Modules De Bar



## BAR MODÜLLERİ

BAR MODULES / Modules De Bar

### BAR PREMİX TEZGAHI / BAR PREMIX BENCH /

TR

- Estetik tasarım
- Paslanmaz çelikten imal edilmiş gövde
- Kolay kullanım ve temizlik imkanı
- Demonte yapısı ile tüm yerlere yerleşme
- İstenilen ölçülere göre üretilebilme.

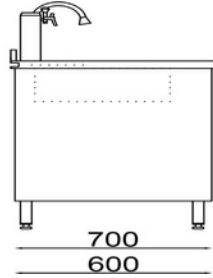
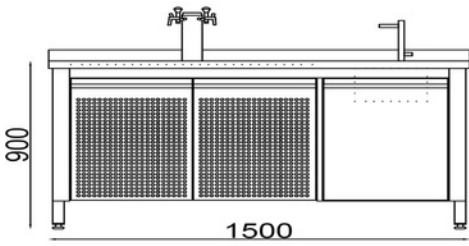

GAST.BR100

### BAR ŞİŞE STANDI / BAR BOTTLE SIT / BAR BOUTEILLE ASSIS

EN

- Aesthetic design
- Body made of stainless steel
- Easy to use and clean
- Settlement in all places with its demountable structure
- Can be produced according to the desired dimensions.

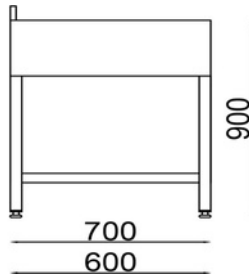
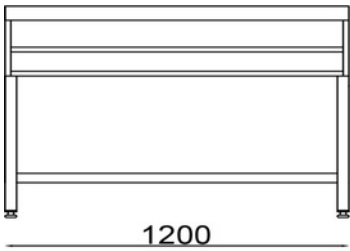

GAST.BSS200

### DOLAPLI BAR ŞİŞE STANDI/ BAR BOTTLE STAND WITH CABINET / BAR AVEC ARMOIRE

FR

- Conception esthétique
- Corps en acier inoxydable
- Facile à utiliser et à nettoyer
- Implantation en tous lieux grâce à sa structure démontable - Peut être produit selon les dimensions désirées.

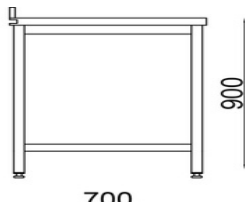
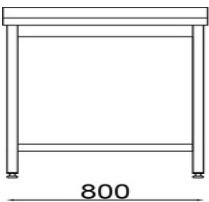

GAST.DBS500



## BAR MODÜLLERİ

BAR MODULES / Modules De Bar

### BAR EVYESİ/ BAR SINK / ÉVIER DE BAR

TR

- Estetik tasarım
- Paslanmaz çelikten imal edilmiş gövde
- Kolay kullanım ve temizlik imkanı
- Demonte yapısı ile tüm yerlere yerleşme
- İstenilen ölçülere göre üretilebilme.

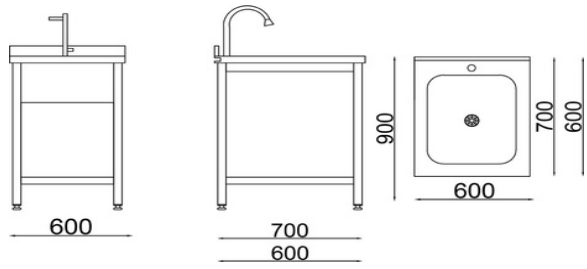

GAST.BEV100

### BAR HAZIRLIK STANDI / BAR PREPARATION / PRÉPARATION DE LA BARRE

EN

- Aesthetic design
- Body made of stainless steel
- Easy to use and clean
- Settlement in all places with its demountable structure
- Can be produced according to the desired dimensions.

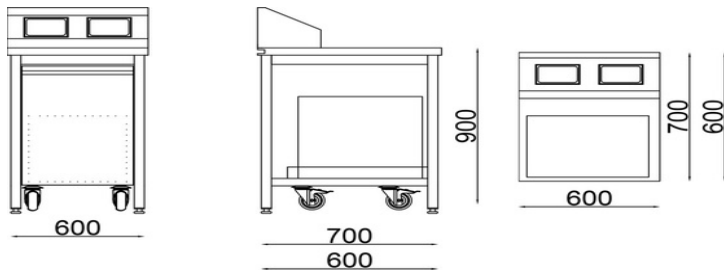

GAST.BHS100

### ÇÖP KOVALI BAR MODÜLÜ/ BAR MODULE WITH WASTE BASKET / C SEAU A

FR

- Conception esthétique
- Corps en acier inoxydable
- Facile à utiliser et à nettoyer
- Implantation en tous lieux grâce à sa structure démontable - Peut être produit selon les dimensions désirées.

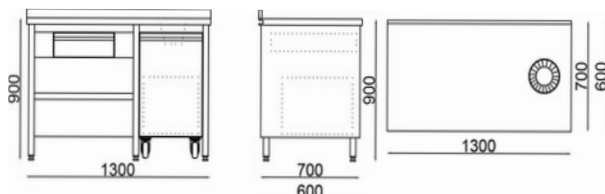

GAST.BMC200

## BAR MODÜLLERİ

BAR MODULES / Modules De Bar

### BAR PREMİX TEZGAHI / BAR PREMIX BENCH

TR

- Estetik tasarım
- Paslanmaz çelikten imal edilmiş gövde
- Kolay kullanım ve temizlik imkanı
- Demonte yapısı ile tüm yerlere yerleşme
- İstenilen ölçülere göre üretilebilme.

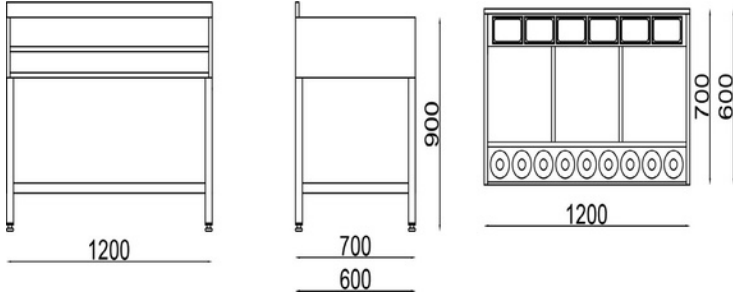

GAST.BS100

### ÇEKMECELİ BAR STANDI / BAR STAND WITH DRAWERS / BAR STAND AVEC TIROIRS

EN

- Aesthetic design
- Body made of stainless steel
- Easy to use and clean
- Settlement in all places with its demountable structure
- Can be produced according to the desired dimensions.

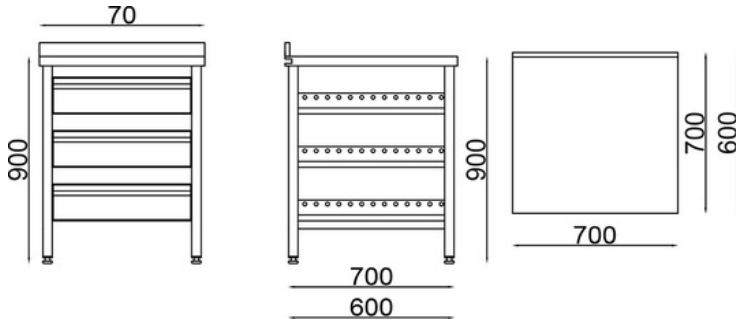

GAST.CBS100

### BARDAK SÜZME MODÜLÜ / CUP FILTER MODULE / FILTRE TASSE

FR

- Conception esthétique
- Corps en acier inoxydable
- Facile à utiliser et à nettoyer
- Implantation en tous lieux grâce à sa structure démontable - Peut être produit selon les dimensions désirées.

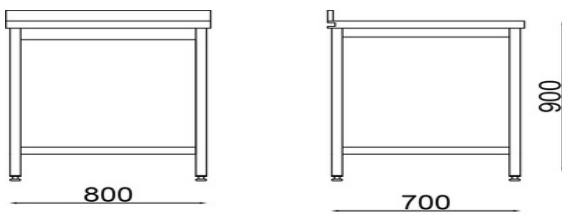

GAST.BSM100